

User's and Programming Guide

Agilent Technologies

ESG Family Signal Generators

Option UN8 Real-Time I/Q

Baseband Generator with TDMA Standards

Includes Option 202, EDGE

IMPORTANT The material in this manual is based on the most recent firmware revision and Option UN8 hardware Revision C. If the functions and display of the signal generator differ from this manual, a firmware/hardware upgrade may be needed.

Serial Number Prefixes

(Affix Label Here)



Part Number E4400-90327

Printed in USA

June 2001

Supersedes June 2000

© Copyright 1999-2001 Agilent Technologies

Contents

1. Overview of Modulation Formats

APCO 25	1-2
Bluetooth.....	1-3
CDPD	1-4
Custom	1-5
DECT	1-6
EDGE (Option 202 Only).....	1-7
GSM	1-8
NADC	1-9
PDC.....	1-10
PHS.....	1-11
TETRA	1-12

2. Using Functions

Setting Up Framed Digital Modulation	2-2
Setting the Carrier Frequency	2-2
Setting the Power Level.....	2-2
Selecting the Desired Format	2-3
Setting Up the First Timeslot.....	2-3
Setting Up the Second Timeslot	2-4
Using Custom Format	2-5
Turning On a Format and the Modulation.....	2-6
Customizing the Burst Shape	2-7
Changing Rise and Fall Times and Adding Delay.....	2-8
Defining the Shape of the Burst Curve	2-9
Mapping Custom Differential Encoding.....	2-11
Mapping Symbol Positions with the I/Q Table Editor	2-15
Creating a Symbol Map.....	2-16
Moving an I/Q Symbol.....	2-19
Globally Replacing an I/Q Value.....	2-21
Building a Customized FSK Modulation with the FSK Table Editor.....	2-22
Choosing the Define User FSK Setting	2-22
Creating a Unique FSK File of Frequency Deviations	2-23
Modifying a Default FSK Pattern.....	2-24
Creating User-Defined FIR Filters	2-26

Contents

Creating a User-Defined FIR Filter by Entering Values	2-26
Modifying an Existing FIR Filter with the FIR Table Editor	2-30
Storing User-Defined Files to Memory	2-33
Selecting Stored Files	2-35
Applying a Stored I/Q Map	2-35
Applying a User-Defined FIR Filter	2-36
Selecting a Custom FSK File	2-37
Using the Bit File Editor	2-38
Creating a User File	2-38
Modifying an Existing User File	2-40
3. Softkey Reference	
Symbols	3-2
%	3-2
p/4 DQPSK	3-2
Numerics	3-3
2-Lvl FSK	3-3
3-Bit Sync	3-3
4 1's & 4 0's	3-4
4-Lvl FSK	3-5
4QAM	3-6
8 1's & 8 0's	3-6
8-Lvl FSK	3-8
8PSK	3-9
16 1's & 16 0's	3-9
16-Lvl FSK	3-11
16PSK	3-11
16QAM	3-12
32 1's & 32 0's	3-13
32QAM	3-14
64 1's & 64 0's	3-15
64QAM	3-16
256QAM	3-17
800 MHz Base	3-17
800 MHz Mobile	3-18
1500 MHz Base	3-18
1500 MHz Mobile	3-18

Contents

A	3-19
A field	3-19
Access	3-19
All Timeslots	3-19
APCO 25 C4FM	3-20
APCO 25 w/C4FM	3-20
APCO 25 w/CQPSK	3-20
B	3-21
B	3-21
B field	3-21
B1	3-21
B2	3-22
Base	3-22
BBG Data Clock Ext Int	3-22
Begin Frame	3-22
Begin Pattern	3-23
Begin Timeslot	3-23
Beta	3-24
Bit Clock	3-24
Bluetooth	3-24
BNC MUX Settings	3-24
BPSK	3-24
Burst Shape	3-25
Burst Shape Type	3-25
Bus	3-26
C	3-27
C4FM	3-27
CC	3-28
CDPD	3-28
CDVCC	3-28
CS-1	3-28
Channel Band	3-28
Channel Number	3-29
Configure Access	3-29
Configure Custom	3-30
Configure Differential Encoding	3-31
Configure Dn Custom Cont	3-32

Contents

Configure Dn Custom Disc	3-33
Configure Dn Normal Cont.	3-34
Configure Dn Normal Disc	3-35
Configure Dn Sync Cont	3-36
Configure Dn Sync Disc	3-37
Configure Down Custom.	3-38
Configure Down TCH	3-39
Configure Dummy	3-41
Configure Dummy Bearer 1	3-42
Configure Dummy Bearer 2	3-43
Configure FCorr	3-44
Configure Frame	3-45
Configure Hardware	3-45
Configure Low Capacity	3-45
Configure Low Capacity with Z Field	3-46
Configure Normal	3-47
Configure Sync	3-50
Configure TCH	3-52
Configure Timeslots	3-53
Configure Traffic Bearer	3-54
Configure Traffic Bearer with Z Field	3-55
Configure Up Control 1.	3-56
Configure Up Control 2.	3-57
Configure Up Custom	3-58
Configure Up Normal	3-59
Configure Up TCH	3-60
Configure Up VOX	3-62
Control Channel Dnlink Uplink.	3-63
Copy File	3-63
Create a File	3-63
CSID.	3-63
Custom.	3-64
Custom Off On.	3-64
Custom TS	3-65
D	3-66
D8PSK	3-66
Data	3-66

Contents

Data Format Pattern Framed	3-68
Data Clk Out	3-69
Data Out	3-70
DCS Base	3-70
DCS Mobile	3-70
DECT	3-70
DECT Off On	3-70
Dect Patterns	3-70
Define User Burst Shape	3-71
Define User FIR	3-71
Define User FSK	3-72
Define User I/Q	3-72
Delete	3-72
Delete All Rows	3-72
Delete Bits	3-73
Delete Row	3-73
Delete to Beginning	3-73
Delete to End	3-73
Diff Data Encode Off On	3-73
Differential Encoding Off On	3-73
Display Burst Shape	3-74
Display FFT	3-74
Display Impulse Response	3-75
Display I/Q Map	3-75
DM0	3-76
DM1	3-76
Dn Custom Cont.	3-76
Dn Custom Disc	3-77
Dn Normal Cont.	3-77
Dn Normal Disc	3-78
Dn Sync Cont	3-78
Dn Sync Disc	3-79
Down Custom	3-79
Downlink MCS-1	3-80
Downlink MCS-5	3-80
Downlink MCS-9	3-80
Down TCH	3-80

Contents

Down TCH All	3-81
Dummy	3-81
Dummy Bearer 1	3-81
Dummy Bearer 2	3-81
E	3-82
E	3-82
E Field Data	3-82
E-GSM Base	3-82
E-GSM Mobile	3-82
E-TCH/F43.2	3-83
EDGE	3-83
EDGE (Rev 8.3.0 Release 1999)	3-83
EDGE Off On	3-83
Edit Fall Shape	3-84
Edit File	3-84
Editing Keys	3-84
Edit Item	3-85
Edit Rise Shape	3-85
ET	3-85
Event 1	3-85
Ext	3-86
Ext Data Clock Normal Symbol	3-87
Ext Delay Bits	3-88
Ext Delay Off On	3-89
External 13 MHz Off On	3-89
F	3-90
FACC	3-90
Fall Delay	3-90
Fall Time	3-91
FCOR	3-91
FCorr	3-91
FDEV1_FS	3-92
FDEV1_HS	3-92
FDEV2_FS	3-92
Filter	3-93
Filter Alpha	3-93
Filter BbT	3-94

Contents

Filter Factor N/A	3-95
Filter Symbols	3-95
FIX4	3-96
Frame Repeat Single Cont	3-97
Frame Trigger	3-98
Freq Channels	3-99
Freq Channels Off On	3-99
Freq Dev	3-99
FSK	3-100
G	3-101
G	3-101
Gated	3-101
Gated Clock	3-102
Gaussian	3-102
Globally Replace Selected Item	3-103
Goto Bottom Row	3-103
Goto Middle Row	3-103
Goto Row	3-103
Goto Top Row	3-103
Gray Coded QPSK	3-104
GSM	3-104
GSM 450 Base	3-104
GSM 450 Mobile	3-105
GSM 450/850 Base	3-105
GSM 450/850 Mobile	3-105
GSM 480 Base	3-105
GSM 480 Mobile	3-105
GSM 850 Base	3-105
GSM 850 Mobile	3-106
GSM Off On	3-106
H	3-107
Hamming	3-107
Hann	3-107
I	3-108
IDLE	3-108
Insert	3-108
Insert 1's	3-108

Contents

Insert 0's	3-108
Insert Row	3-108
Interleave Gating	3-108
I/Q Scaling	3-109
IS-95	3-109
IS-95 and IS-2000	3-109
IS-95 Mod	3-109
IS-95 w/EQ	3-110
IS-95 Mod w/EQ	3-110
IS95 OQPSK	3-110
IS95 QPSK	3-111
K	3-112
Kaiser	3-112
L	3-113
Load Default FIR	3-113
Load Default FSK	3-113
Load Default I/Q Map	3-113
Load From Selected File	3-113
Load Mirror Image of Fall Shape	3-114
Load Mirror Image of Rise Shape	3-114
Load/Store	3-114
Low Capacity	3-115
Low Capacity with Z Field	3-115
M	3-116
Manual Reset & Run	3-116
Mirror Table	3-116
Mobile	3-116
Modify Standard	3-116
Modulation Type	3-117
More	3-117
MSK	3-117
Multiframe Channel	3-118
Multiframe Data	3-118
Multiframe Trigger	3-118
N	3-119
NADC	3-119
NADC Off On	3-119

Contents

None	.3-119
Normal	.3-120
Normal All	.3-120
Number of Bits	.3-120
Nyquist	.3-120
O	.3-122
Offset Q Off On	.3-122
Optimize FIR For EVM ACP	.3-122
OQPSK	.3-123
Other Patterns	.3-124
Oversample Ratio	.3-125
P	.3-126
Page Down	.3-126
Page Up	.3-126
Pattern Repeat Single Cont.	.3-126
Pattern Trigger	.3-126
PCS Base	.3-127
PCS Mobile	.3-127
PDC	.3-127
PDC Off On	.3-127
P-GSM Base	.3-127
P-GSM Mobile	.3-127
PHS	.3-128
PHS Off On	.3-128
Phase Dev	.3-128
Phase Polarity Normal Invert	.3-128
PN9	.3-129
PN11	.3-130
PN15	.3-131
PN20	.3-133
PN23	.3-134
PN Sequence	.3-135
Predefined Mode	.3-136
PSID	.3-136
PSK	.3-137
Q	.3-138
QAM	.3-138

Contents

QPSK	3-139
QPSK and OQPSK	3-140
R	3-141
Rate Full Half	3-141
Recall Secondary Frame State	3-141
Rectangle	3-141
Rename	3-142
Reset & Run	3-142
Restore DECT Factory Default	3-142
Restore Default Burst Shape	3-143
Restore Default Filter	3-143
Restore Default Modulation Type	3-144
Restore Default Symbol Rate	3-144
Restore EDGE Factory Default	3-145
Restore GSM Factory Default	3-145
Restore NADC Factory Default	3-145
Restore PDC Factory Default	3-145
Restore PHS Factory Default	3-145
Restore TETRA Factory Default	3-145
R-GSM Base	3-145
R-GSM Mobile	3-146
Rise Delay	3-146
Rise Time	3-146
Root Nyquist	3-147
S	3-148
S	3-148
SA	3-148
SACCH	3-149
Save Secondary Frame State	3-149
Scramble Off On	3-149
Scramble Seed	3-150
Secondary Frame Off On	3-150
Secondary Frame Trigger	3-151
Select	3-151
Select File	3-152
Sine	3-152
Single Shot	3-152

Contents

SS	3-153
SSB	3-154
Standard	3-154
Store To File	3-154
STS	3-154
SW	3-155
Symbol Rate	3-155
Symbol Sync Out	3-155
SYNC	3-156
Sync	3-156
Sync Out	3-156
Sync Out Offset	3-157
T	3-158
T1, T2	3-158
TCH	3-158
TCH All	3-159
TCH/FS	3-159
TDMA	3-159
TETRA	3-159
TETRA Off On	3-160
Timeslot #	3-160
Timeslot Ampl Main Delta (Option UNA only)	3-160
Timeslot Off On	3-161
Timeslot Type	3-161
Traffic Bearer	3-162
Traffic Bearer with Z Field	3-162
Transmit Link RFP PP	3-162
Trigger In Polarity Neg Pos	3-163
Trigger Key	3-163
TS	3-164
TSC0 - TSC7	3-165
U	3-166
UN3/4 GSM Gaussian	3-166
Uncoded	3-166
Up Control 1	3-166
Up Control 2	3-167
Up Custom	3-167

Contents

Uplink MCS-1	3-168
Uplink MCS-5	3-168
Uplink MCS-9	3-168
Up Normal	3-169
Up TCH	3-169
Up TCH All	3-169
Up VOX	3-170
User File	3-170
User FIR	3-172
User FSK	3-172
User I/Q	3-172
UW	3-173
W	3-174
Window	3-174

4. Programming Commands and Examples

Programming Commands	4-2
A Field	4-2
B Field	4-4
Broadcast Bit Field	4-8
Burst Configuration - State, Type, Rise/Fall Time, Rise/Fall Delay, PN9 Mode	4-9
Cell Station Identification Code (CSID) Field	4-12
Coded Digital Channel Locator (CDL) Field	4-13
Coded Digital Verification Color Code (CDVCC) Field	4-13
Color Code Field	4-13
Data Clock Input Configuration	4-14
Data Selection for Framed Transmissions	4-14
Data Selection for Unframed Transmissions	4-29
Data Out	4-30
Default State	4-30
Differential Data Encoding	4-30
Differential Encoding	4-31
EDGE BNC MUX Settings	4-31
Extended Tail (ET) Field	4-32
External 13 MHz Reference State	4-32
External Data Clock Configuration	4-32
External Data Delay Query	4-33

Contents

External Frame Trigger Configuration - Delay Bits, Delay State, Type	4-33
Frame Repeat	4-34
Frame Transmission Rate	4-35
Frequency Channel Configuration - Band, Number, and State	4-36
Filter Configuration - Alpha, BbT, Optimization, Type	4-38
FIX4 Data	4-40
Frequency Correction (FCOR) Field	4-52
FSK Deviation	4-52
Guard Field	4-53
Idle Field	4-53
I/Q Scaling	4-54
Leading Broadcast Bit (B1) Field	4-54
Mode State	4-55
Modulation Configuration - Type, User FSK, User I/Q	4-55
MSK Phase	4-60
P Field	4-60
Multiframe PN Sequence	4-62
Personal Station ID Code	4-64
Phase Polarity	4-64
PN9 Mode	4-65
Predefined Mode	4-65
S Field	4-65
Scramble Configuration - Seed and State	4-67
Secondary Frame Configuration - Recall, Save, Trigger, State	4-68
Slow Associated Control Channel (SACCH) Field	4-69
Steal Bit	4-71
Symbol Rate	4-71
Sync Output Configuration - Type, Timeslot, Offset	4-71
Synchronization Block Bits (SSB) Field	4-73
Synchronization Sequence Field	4-73
Synchronization Training Sequence Bits (STS) Field	4-74
Synchronization Word Field	4-74
Tail (T1, T2) Fields	4-75
Timeslot Configuration - Amplitude, State, Type	4-75
Trailing Broadcast Bit (B2) Field	4-82
Training Sequence Field	4-82
Trigger Source	4-86

Contents

Unique Word Field	4-86
User FSK Files	4-87
User I/Q Files	4-87
Programming Examples	4-88
Generating a $\pi/4$ DQPSK Modulation Sensitivity Bit Error Test	4-89
Generating a DECT GFSK Modulation Sensitivity Bit Error Test	4-96
Generating a GSM GMSK Modulation Sensitivity Bit Error Test	4-98
Generating a PDC Sensitivity Bit Error Test	4-100
5. Softkey/Command Cross-Reference	5-2
6. Theory of Operation	
RF Modulation with Option UN8/9	6-2
Data and Control Bits in Pattern RAM	6-3
Alternate Amplitude and Alternate Timeslot Amplitude Control (Option UNA only)	6-4
Burst Shape: The Effects of Symbol Rate & Modulation Type	6-6
Data Clock Timing Patterns	6-8
Digital Modulation Input/Output Relationships	6-9
Understanding Differential Data Encoding	6-10
Understanding Differential Encoding	6-11

1 Overview of Modulation Formats

This manual describes the digital modulation capability provided by the Real-Time I/Q Baseband Generator with TDMA formats (Option UN8 and includes Option 202). Overviews are provided in this chapter, as well as the operating and programming information and examples in the following chapters.

The modulation formats are described as follows:

- “[APCO 25](#)” on page 1-2
- “[Bluetooth](#)” on page 1-3
- “[CDPD](#)” on page 1-4
- “[Custom](#)” on page 1-5
- “[DECT](#)” on page 1-6
- “[EDGE \(Option 202 Only\)](#)” on page 1-7
- “[GSM](#)” on page 1-8
- “[NADC](#)” on page 1-9
- “[PDC](#)” on page 1-10
- “[PHS](#)” on page 1-11
- “[TETRA](#)” on page 1-12

APCO 25

The Association of Public-Safety Communications Official-International, Inc., Project 25 (APCO 25) is a standard setting initiative for public-safety communications.

The primary objectives of the APCO Project 25 standards process are to provide digital narrowband radios optimum performance, meet all public-safety user needs, and achieve maximum interoperability.

The Project 25 documents were developed by the Telecommunications Industry Association (TIA), based on user needs, and then approved by the APCO Project 25 Steering Committee before being published as TIA documents.

The basic characteristics of Project 25 radios are the following:

- a Phase I emission designator of 8K10F1E-compatible four-level frequency modulation (C4FM) for operation in a 12.5 kHz channel
- a Phase II emission designator of 5K76G1E-compatible quadrature phase shift keying (CQPSK) modulation for operation in a 6.25 kHz channel

NOTE The only difference between Phase I C4FM and Phase II CQPSK is the modulation method in the transmitter.

- use of a common receiver for both C4FM and CQPSK modulation to ensure full interoperability between the two signals
- encryption defined for the U.S. Data Encryption Standard (DES) algorithms, but other techniques can also be employed
- use of an improved multiband excitation (IMBE) vocoder with 4400 bits/s of digitized voice, 3800 bits/s of error correction on the voice, and 2400 bits/s of signaling overhead, for an aggregate bit rate of 9600 bits/s

Bluetooth

Bluetooth is a global specification for wireless communication. It provides limited range RF connectivity for voice and data transmissions between electronic devices without the use of cables.

Promoted by the Bluetooth Special Interest Group (SIG), Bluetooth operates in a globally available unlicensed 2.4 GHz Industrial, Scientific, and Medical (ISM) radio band. Although globally available, the exact location and the width of the band may differ by country.

Bluetooth uses a Frequency Hopping Spread Spectrum (FHSS), and 2-level frequency shift keying (2FSK) modulation that provides 1 bit of data per symbol with a symbol rate of 1 Ms/s. The frequency hopping occurs over 79 channels (23 channels in Spain, France and Japan) spaced 1 MHz apart.

Bluetooth protocol uses a combination of circuit and packet switching. For full duplex transmission, Time-Division Duplex (TDD) is used. Bluetooth uses slotted channels with a nominal slot length of 625 μ s. On the channel, information is exchanged through packets. Each packet is transmitted on a different hop frequency. A packet nominally covers a single slot, but can be extended to cover up to five slots. Slots can be reserved for synchronous packets. Each voice channel supports a 64 kbits/s synchronous channel in each direction. The synchronous channel can support a maximum of 721 kbits/s asymmetric (and still up to 57.6 kbits/s in the return direction), or 432.6 kbits/s symmetric.

NOTE Option UN8 does not implement the FHSS frequency hopping, so it is not spread spectrum

CDPD

Cellular Digital Packet Data (CDPD) is a specification for supporting wireless communications. CDPD is designed to work over Advanced Mobile Phone System (AMPS) or as a protocol for Time Division Multiple Access (TDMA). CDPD is a transparent overlay on an existing AMPS system. It makes use of AMPS channels that are not being utilized by voice traffic.

CDPD enables you to send information in packets over the existing analog cellular network. It is best suited for short periodic bursts of information. The packets of data are sent over the existing infrastructure at a rate of up to 19.2 kbits/s.

Custom

The Real-Time I/Q Baseband Generator enables you to shape the characteristics of a digitally modulated signal. You can use it to create time-domain multiple access signals. You can choose from a variety of modulation types, including QPSK, offset QPSK, BPSK, $\pi/4$ DQPSK, 4-, 16-, 32-, 64-, and 256-QAM, as well as define your own MSK, FSK, and I/Q modulation types.

You can create and modify these custom modulation types using simple table editors, and store custom files to the signal generator's memory where they can be recalled on demand. Using the table editors, you can adjust the signal's data, frequency deviation, I value, Q value, phase deviation, bit rate, filter alpha, FIR coefficient and value, and a channel offset. Also, with user-defined IQ and FSK modulations, you can design custom differential encoding schemes.

DECT

The Digital European Cordless Telecommunications, (DECT) digital communications standard defines an access technology for existing and future networks including PSTN, ISDN and GSM for public applications and PBXs and X.25 for private networking. Because DECT can be used to access any network, a wide range of cordless communications systems are being developed using the DECT standard. The same handset can be used in different applications allowing mobility between systems while offering higher performance, both “in-building” and across wide geographic areas.

The DECT digital communications standard employs a 12:1 Time Division Multiple Access (TDMA), Time Division Duplex (TDD). The raw bit rate, 1.152 Mbits/second, is modulated using a system known as Gaussian Frequency Shift Keying (GFSK). This method deviates the carrier frequency by +288 kHz to represent a logic 1 or -288 kHz to represent a logic 0. The speech rate is 32 kbits/s and the raw data rate is 1.152 Mbits/s. The frequency allocation is 1880 MHz to 1900 MHz. There are ten carriers in this band with a carrier spacing of 1.728 MHz and a channel bandwidth of 1 MHz. The ten carriers are numbered 0 to 9 (where channel nine is the lowest frequency at 1881.792 MHz and channel zero is the highest, at 1897.344 MHz).

Each of these carriers spaced across this 20 MHz band employ Time Division Multiple Access, Time Division Duplex. This means that each carrier can be activated at any one of the 24 available timeslots in a 10 ms timeframe. Duplex communication is achieved by using the first 12 timeslots as the transmit time and the second 12 timeslots as the receive time.

The power level in DECT is fixed at +24 dBm for both the fixed part and portable parts of the system; it does not vary as in cellular systems.

The DECT framing structure is based on a hierarchical system consisting of timeslots, TDMA frames, multiframes, and hyperframes. One traffic bearer burst (from mobile to base station) consists of 390 modulated bits including of guard, preamble, synchronization, signaling/data, and error correction bits. Twelve of these bursts make up one TDMA frame. Eighteen TDMA frames make up one multiframe.

EDGE (Option 202 Only)

The Enhanced Data Rates for GSM Evolution (EDGE) digital communications standard defines a voice and data over-air interface between a mobile radio and the system infrastructure. This standard was designed as the basis for a private radio communications system. A central control center is linked to multiple base station sites which provide the required coverage.

The EDGE digital communications standard employs a 8:1 Time Division Multiple Access (TDMA) allowing eight channels to use one carrier frequency simultaneously. The 812.5 kbits/second raw bit rate is modulated with $3\pi/8$ rotating 8PSK. This standard defines the channel separation as 200 kHz at carrier frequencies between 935 and 960 MHz (downlink transmissions) and 890 to 915 MHz (uplink transmissions) at a power level ranging between 3.7 mW and 20 W. The standard specifies a physical traffic channel (TCH) with two logical components: a logical TCH and the slow associated control channel (SACCH).

The EDGE framing structure is based on a hierarchical system consisting of timeslots, TDMA frames, multiframe, and hyperframes. One traffic channel consists of either 468 or 471 modulated bits including tail, encryption, training sequence, and guard time bits. Eight of these bursts make up one TDMA frame. Twenty-six TDMA frames make up one multiframe. Frames 12 and 25 in the multiframe are dedicated to control channel signaling (SACCH).

Guard time appears in the visual representation of the timeslot as a 24.75-bit field. In the actual implementation, the guard time field in timeslots 0 and 4 are 27 bits long and the remaining timeslots contain 24-bit fields.

GSM

The Global System for Mobile Communication (GSM) digital communications standard defines a voice and data over-air interface between a mobile radio and the system infrastructure. This standard was designed as the basis for a private radio communications system. A central control center is linked to multiple base station sites which provide the required coverage.

The GSM digital communications standard employs a 8:1 Time Division Multiple Access (TDMA) allowing eight channels to use one carrier frequency simultaneously. The 270.833 kbits/second raw bit rate is modulated using a system known as Gaussian Minimum Shift Keying (GMSK). This standard defines the channel separation as 200 kHz at carrier frequencies between 935 and 960 MHz (downlink transmissions) and 890 to 915 MHz (uplink transmissions) at a power level ranging between 3.7 mW and 20 W. The standard includes multiple traffic channels, a control channel, and a cell broadcast channel.

The GSM framing structure is based on a hierarchical system consisting of timeslots, TDMA frames, multiframe, and hyperframes. One traffic channel consists of 156.25 (157) modulated bits including tail, training sequence, encryption, and guard time, and timeslot bits. Eight of these bursts make up one TDMA frame. Twenty-six TDMA frames make up one multiframe. Frames 13 and 26 in the multiframe are dedicated to control channel signaling.

Guard time appears in the visual representation of the timeslot as an 8.25-bit field. In the actual implementation, the guard time field in timeslots 0 and 4 are 9 bits long and the remaining timeslots contain 8 bit fields. (This implementation is documented in the GSM standard "GSM REC. 05.10 Section 5.7" as follows: "Optionally, the BS may use a timeslot length of 157 bit periods on timeslots with TN=0 and 4, and 156 bit periods on timeslots with TN=1, 2, 3, 5, 6, 7, rather than 156.25 bit periods on all timeslots.")

NADC

The North American Digital Cellular digital communications standard defines a voice and data over-air interface between a mobile radio and the system infrastructure. This standard was designed as the basis for a private radio communications system. A central control center is linked to multiple base station sites which provide the required coverage.

The NADC digital communications standard employs a 6:1 Time Division Multiple Access (TDMA) allowing six channels to use one carrier frequency simultaneously. The raw bit rate, 48.6 kbits/second, is modulated using a system known as $\pi/4$ Differential Quadrature Phase Shift Keying ($\pi/4$ DQPSK). This standard defines the channel separation as 30 kHz at carrier frequencies between 824 and 849 MHz (uplink transmissions) and 869 to 894 MHz (downlink transmissions) at a power level ranging from 2.2 mW to 6W (mobile station).

The NADC framing structure is based on a hierarchical system consisting of timeslots, TDMA frames, multiframes, and hyperframes. One Normal Uplink Burst (from mobile to base station) consists of 324 modulated bits consisting of guard, ramp, synchronization word, slow associated control channel, color code, and data bits. Six of these bursts make up one TDMA frame. Eighteen TDMA frames make up one multiframe. Frame 18 in the multiframe is dedicated to control channel signaling.

PDC

The Personal Digital Cellular (PDC) digital communications standard defines a voice and data over-air interface between a mobile radio and the system infrastructure. A central control center is linked to multiple base station sites which provide the required coverage.

The PDC digital communications standard employs a 6:1 Time Division Multiple Access (TDMA) allowing six channels to use one carrier frequency simultaneously. The raw bit rate, 42 kbits/second, is modulated using a system known as $\pi/4$ Differential Quadrature Phase Shift Keying ($\pi/4$ DQPSK). This standard defines the channel separation as 50 kHz (25 kHz interleave) in two separate frequency bands: 810 to 826 MHz (downlink transmission) 940 to 956 MHz (uplink transmission), as well as 1477 to 1501 MHz (downlink transmission) 1429 to 1453 MHz (uplink transmission) at a power level of 0.8 W (mobile station). The standard includes a control channel, multiple traffic channels, and other logical channel types.

The PDC framing structure is based on a hierarchical system consisting of timeslots, TDMA frames, multiframes, and hyperframes. One uplink traffic channel burst (from mobile to base station) consists of 280 modulated bits including ramp, data, preamble, synchronization word, color code, steal flag, slow associated access channel, and guard bits. Six of these bursts make up one TDMA frame. Eighteen TDMA frames make up one multiframe.

PHS

The Personal Handy Phone System (PHS) digital communications standard defines a voice and data over-air interface between a mobile radio and a base station/network interface. A central control center is linked to multiple base station sites which provide the required coverage.

The PHS digital communications standard employs a 4:1 Time Division Multiple Access (TDMA), Time Division Duplex (TDD), allowing eight channels to use one carrier frequency simultaneously. The 384 kbits/second raw bit rate is modulated using a system known as $\pi/4$ Differential Quadrature Phase Shift Keying ($\pi/4$ DQPSK). This standard defines the channel separation as 300 kHz at carrier frequencies between 1895 and 1918 MHz at a power level of 10 mW (mobile station). The standard includes a multiple uplink and downlink traffic channels and a dedicated control (synchronization) channel.

The PHS framing structure is based on a hierarchical system consisting of timeslots, TDMA frames, multiframes, and hyperframes. One transmission burst consists of 240 modulated bits including ramp, start symbol, preamble, unique word, channel identifier, slow associated control channel, traffic channel data, cycle redundancy check, and guard bits. Eight of these bursts make up one TDMA frame. Eighteen TDMA frames make up one multiframe.

TETRA

The Trans European Trunked Radio or TETRA digital communications standard defines a voice and data over-air interface between a mobile radio and the system infrastructure. This standard was designed as the basis for a private radio communications system. A central control center is linked to multiple base station sites which provide the required coverage.

The TETRA digital communications standard employs a 4:1 Time Division Multiple Access (TDMA) allowing four channels to use one carrier frequency simultaneously. The raw bit rate, 36k bits/second, is modulated using a system known as $\pi/4$ Differential Quadrature Phase Shift Keying ($\pi/4$ DQPSK). This standard defines the channel separation as 25 kHz at carrier frequencies surrounding 400 MHz. The standard includes a Broadcast Control Channel, multiple Traffic Channels, and a host of other logical channel types.

The TETRA framing structure is based on a hierarchical system consisting of timeslots/bursts, TDMA frames, multiframe, and hyperframes. One Normal Uplink Burst (from mobile to base station) consists of 510 modulated bits consisting of ramp, tail, training, data, and guard bits. Four of these bursts make up one TDMA frame. Eighteen TDMA frames make up one multiframe. Frame 18 in the multiframe is dedicated to control channel signaling.

2 Using Functions

This chapter contains procedures that show you how to use some of the major functions of real-time I/Q baseband signal generation (Option UN8 and the EDGE format Option 202):

- “[Setting Up Framed Digital Modulation](#)” on page 2-2
- “[Using Custom Format](#)” on page 2-5
- “[Turning On a Format and the Modulation](#)” on page 2-6
- “[Customizing the Burst Shape](#)” on page 2-7
- “[Mapping Custom Differential Encoding](#)” on page 2-11
- “[Mapping Symbol Positions with the I/Q Table Editor](#)” on page 2-15
- “[Building a Customized FSK Modulation with the FSK Table Editor](#)” on page 2-22
- “[Creating User-Defined FIR Filters](#)” on page 2-26
- “[Storing User-Defined Files to Memory](#)” on page 2-33
- “[Selecting Stored Files](#)” on page 2-35
- “[Using the Bit File Editor](#)” on page 2-38

The material in this chapter is presented with the assumption that you are familiar with basic instrument operation, such as setting power level and frequency, and using a table editor. If you are not, refer to the quick start guide before using the procedures in this chapter.

NOTE	When you see <i>desired format</i> in a menu path, it means to choose the appropriate softkey for the communication standard that you are working in: <ul style="list-style-type: none">• Custom• DECT• EDGE (Option 202)• GSM• NADC• PDC• PHS• TETRA
-------------	--

Setting Up Framed Digital Modulation

Use the following procedure to configure the signal generator to output a framed digitally-modulated signal. The basic steps to the procedure are to:

- Set the carrier frequency ([see below](#))
- Set the power level ([see below](#))
- Select the desired format ([page 2-3](#))
- Choose a timeslot and select a data pattern for it ([page 2-3](#))
- Choose a second timeslot and select a data pattern for it ([page 2-4](#))
- Turn on the modulation ([page 2-6](#))

Setting the Carrier Frequency

1. Preset the signal generator to normal preset conditions.
2. Set the frequency to:

- | | |
|------------------------|-----------------------|
| • Custom: 1.894880 GHz | • NADC: 835 MHz |
| • DECT: 1.890000 GH | • PDC: 832 MHz |
| • EDGE: 891 MHz | • PHS: 1.89515 GHz |
| • GSM: 891 MHz | • TETRA: 1.894880 GHz |

Setting the Power Level

Set the power level (in dBm) to:

- | | |
|-------------|------------|
| • Custom: 0 | • NADC: 0 |
| • DECT: -10 | • PDC: 0 |
| • EDGE: -5 | • PHS: 0 |
| • GSM: -5 | • TETRA: 0 |

Selecting the Desired Format

Press the front panel **Mode** key and press **TDMA > Real Time I/Q BaseBand** (if it appears) > *desired format* to select the communication standard that you want.

Setting Up the First Timeslot

1. Toggle the **Data Format Pattern Framed** softkey to **Framed**.

When you choose framed data, the timeslots that you activate are bursted, and there is no RF carrier during the off timeslots.

2. Press the softkey **Configure Timeslots**.
3. Set the following conditions:

Format	Timeslot #	Timeslot Type	Data Pattern ¹	Timeslot On/Off
DECT	0	Custom	8 1's & 8 0's	On
EDGE & GSM				
NADC	1	Uplink Control 1 (Up TCH)	FIX4, 0101	
PDC	0	Downlink Traffic Channel (Down TCH)		
PHS	Downlink 1	Custom		
TETRA	1	Uplink Control 1 (Up Control 1)		

¹*Softkey Locations*

DECT: **Configure Custom > Other Patterns > 8 1's & 8 0's**

All others: **Configure *timeslot type* > Data > FIX4**, then enter 0101

Setting Up the Second Timeslot

Return to the Configure Timeslots menu and set the following conditions:

Format	Timeslot #	Timeslot Type	Data Pattern ¹	Timeslot On/Off
DECT	11	Traffic Bearer	4 1's & 4 0's	On
EDGE	7	Normal		
GSM	7	Normal		
NADC	3	Uplink Traffic Channel (Up TCH)		
PDC	2	Downlink Traffic Channel (Down TCH)		
PHS	Uplink 1	Custom		
TETRA	3	Uplink Custom (Up Custom)		

¹*Softkey Locations:*

- DECT: **Configure Traffic Bearer > Other Patterns > B field > 4 1's & 4 0's**
- EDGE: **Configure Normal > E > 4 1's & 4 0's**
- GSM: **Configure Normal > E > 4 1's & 4 0's**
- NADC: **Configure Up TCH > Data > Other Patterns > 4 1's & 4 0's**
- PDC: **Configure Down TCH > TCH > Other Patterns > 4 1's & 4 0's**
- PHS: **Configure Custom > Other Patterns > 4 1's & 4 0's**
- TETRA: **Configure Up Custom > Other Patterns > 4 1's & 4 0's**

Using Custom Format

The Custom format enables you to create a unique, unframed digital modulation. The following figure shows the Custom menu (**Mode > Real Time I/Q BaseBand (if it appears) > Custom**), and the default values for this format.

Using the softkeys in this menu, you can edit any of the default values.

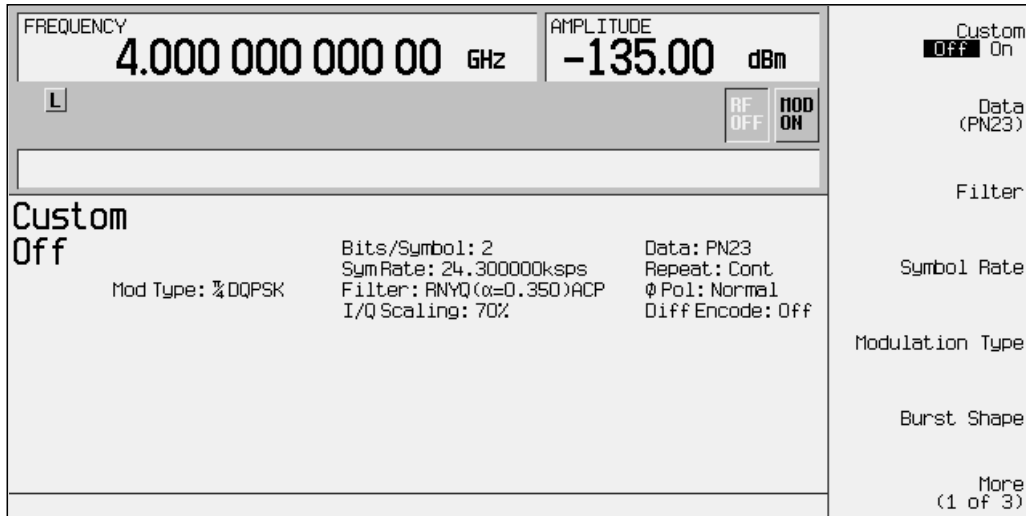

Procedures are provided in this chapter for specific types of editing:

- “Customizing the Burst Shape” on page 2-7
- “Mapping Custom Differential Encoding” on page 2-11
- “Mapping Symbol Positions with the I/Q Table Editor” on page 2-15
- “Building a Customized FSK Modulation with the FSK Table Editor” on page 2-22
- “Creating a User-Defined FIR Filter by Entering Values” on page 2-26
- “Storing User-Defined Files to Memory” on page 2-33
- “Selecting Stored Files” on page 2-35

Turning On a Format and the Modulation

Once you have the modulation set up as you want, use the following steps to apply it to a carrier.

1. Go to the first *desired format* menu and toggle the modulation format on.

Annunciators turn on to indicate:

- that you have enabled the standard
 - that I/Q modulation is being generated
2. Set the desired frequency.
 3. Set the desired power.
 4. When the instrument is preset, modulation is On by default. If the MOD ON annunciator is not enabled, press the front panel **Mod On/Off** hardkey to display the annunciator and apply the custom modulation to the carrier.
 5. Turn on the RF output.

Customizing the Burst Shape

The default burst shape of each format is implemented according to the standards of the format selected. You can, however, modify the following aspects of the burst shape:

- Rise time - the period of time, specified in bits, where the burst increases from a minimum of -70 dB (0) to full power (1).
- Fall time - the period of time, specified in bits, where the burst decreases from full power (1) to a minimum of -70 dB (0).
- Rise delay - the period of time, specified in bits, that the start of the burst rise is delayed. Rise delay can be either negative or positive. Entering a delay other than zero shifts the full power point earlier or later than the beginning of the first useful symbol.
- Fall delay - the period of time, specified in bits, that the start of the burst fall is delayed. Fall delay can be either negative or positive. Entering a delay other than zero shifts the full power point earlier or later than the end of the last useful symbol.
- User-defined burst shape - up to 256 user-entered values which define the shape of the curve in the specified rise or fall time. The values can vary between 0 (no power) and 1 (full power) and are scaled linearly. Once specified, the values are resampled as necessary to create the cubic spline that passes through all of the sample points.

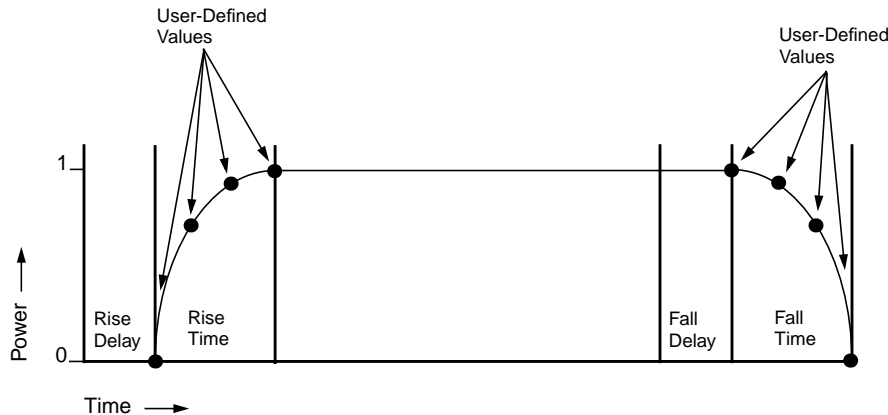

Try the following procedures which demonstrate customizing the burst shape.

NOTE For further information on burst shape, see [“Burst Shape: The Effects of Symbol Rate & Modulation Type”](#) on page 6-6.

Changing Rise and Fall Times and Adding Delay

1. Press the front panel **Mode** hardkey.
2. In the softkey menu, press **Real Time I/Q BaseBand** (if it appears) > **Custom** > **Burst Shape**

Other Formats: **Real Time I/Q BaseBand** (if it appears) > **TDMA** > *desired format* > **More (1 of 2)** > **Modify Standard** > **Burst Shape**

The softkeys for adjusting the rise and fall times and delays are displayed. The following figure shows this menu in the Custom format.

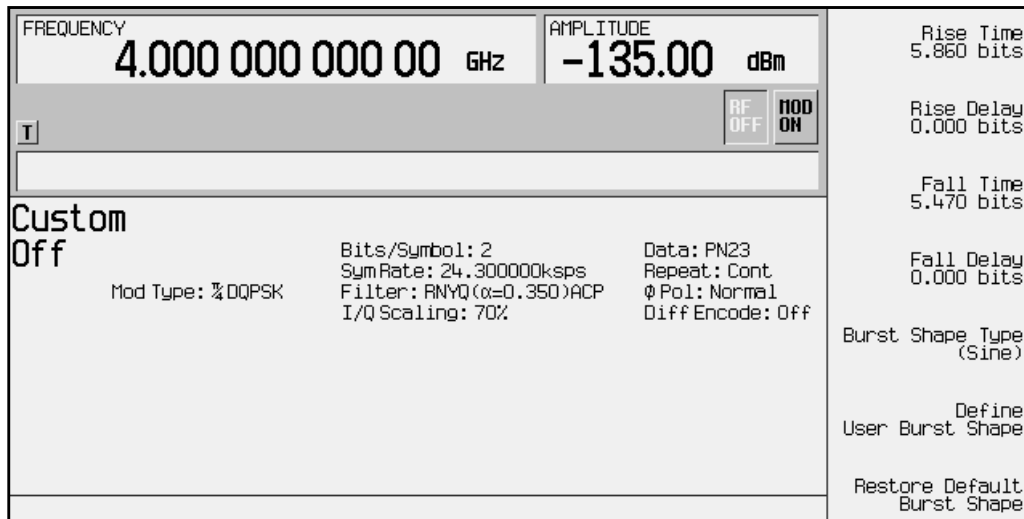

3. Now you can change the rise and fall times and delays by pressing the proper softkey and entering a new value.

NOTE To return the burst to the default conditions, press the **Restore Default Burst Shape** softkey.

Defining the Shape of the Burst Curve

You can adjust the shape of the rise time curve and the fall time curve using the rise shape and fall shape editors. Each editor allows you to enter up to 256 values, equidistant in time, to define the shape of the curve. The values are then resampled to create the cubic spline that passes through all of the sample points.

1. To access the editors, press **Define User Burst Shape**. The editors are shown in the following figure. Notice that the cursor is active in the Rise Shape Editor.

FREQUENCY 4.000 000 000 00 GHz		AMPLITUDE -135.00 dBm		Edit Item
T		RF OFF		Insert Row
				Delete Row
Rise Shape Editor		Fall Shape Editor		Goto Row▶
Sample	Value	Sample	Value	Edit Fall Shape
0	0.000000	0	1.000000	Load Mirror Image of Fall Shape
1	1.000000	1	0.000000	
2	-----	2	-----	
				More (1 of 2)

2. Enter values in the Rise Shape Editor to match those shown in the following figure.
3. Press **Edit Fall Shape** to activate the cursor in the Fall Shape Editor.
4. Press **Load Mirror Image of Rise Shape** and the confirm softkey to change the fall shape values to a mirror image of the rise shape values.

FREQUENCY 4.000 000 000 00 GHz		AMPLITUDE -135.00 dBm		Edit Item
T		RF OFF		Insert Row
				Delete Row
Rise Shape Editor (UNSTORED)		Fall Shape Editor (UNSTORED)		Goto Row▶
Sample	Value	Sample	Value	Edit Rise Shape
0	0.000000	0	1.000000	Load Mirror Image of Rise Shape
1	0.400000	1	0.990000	
2	0.600000	2	0.980000	
3	0.750000	3	0.950000	
4	0.830000	4	0.900000	
5	0.900000	5	0.830000	
6	0.950000	6	0.750000	
7	0.980000	7	0.600000	
8	0.990000	8	0.400000	
9	1.000000	9	0.000000	
				More (1 of 2)

5. Press **Display Burst Shape** to view a graphical representation of the waveform's rise and fall characteristics, as shown.

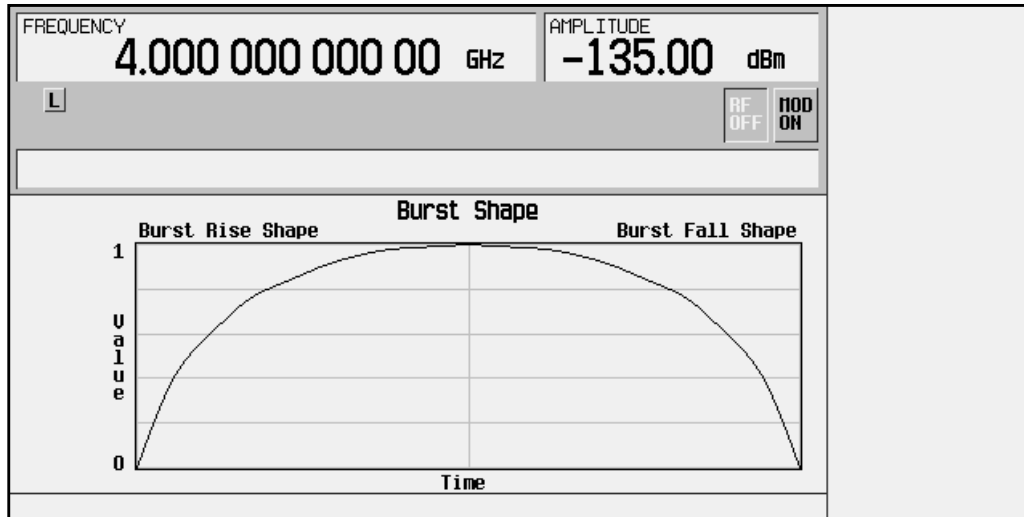

6. To use the new burst shape, first store the file, then load it. For help in executing these store and load functions, refer to [“Storing User-Defined Files to Memory”](#) on page 2-33 and to [“Selecting Stored Files”](#) on page 2-35.

NOTE You can also design burst shape files externally and download the data to the signal generator. For more information see [“Burst Shape Files, Creating”](#) on page 4-10.

Mapping Custom Differential Encoding

Differential encoding is a digital-encoding technique that denotes a binary value by a signal *change* rather than a particular signal state. The signal generator has an editor that enables you to manipulate the differential state map associated with user-defined I/Q and user-defined FSK modulations. Using differential encoding, you can encode binary data encoded during the modulation process via transitions between states defined in the symbol table. Once you configure the differential encoding, you can activate and apply it to the current user-defined modulation.

NOTE For more details, see “[Understanding Differential Encoding](#)” on page 6-11.

Creating a User-Defined I/Q Modulation

Before you design a custom differential encoding scheme, you must first create a user-defined I/Q or FSK modulation. For the purposes of this example, you will create a user-defined 4QAM I/Q modulation from the signal generator’s list of default I/Q maps.

1. Press **Mode > Real Time I/Q Base Band** (if it appears) **> Custom > Modulation Type > Define User I/Q > More (1 of 2) > Load Default I/Q Map > QAM > 4QAM**

Other Formats: **Mode > Real Time I/Q Base Band** (if it appears) **> TDMA > *desired format* > More (1 of 2) > Modify Standard > Modulation Type > Define User I/Q > More (1 of 2) > Load Default I/Q Map > QAM > 4QAM**

This loads a default 4QAM I/Q modulation and displays it in the I/Q table editor.

The default 4QAM I/Q modulation contains data that represent 4 symbols (00, 01, 10, and 11) mapped into the I/Q plane using 2 distinct values (1.000000 and -1.000000). These 4 symbols will be traversed during the modulation process by the symbol table offset values associated with each symbol of data.

I/Q Values Data	I Value	Q Value	Distinct Values
00000000	1.000000	1.000000	1
00000001	-1.000000	1.000000	2
00000010	-1.000000	-1.000000	3
00000011	1.000000	-1.000000	4
00000100	-----	-----	5
			6
			7
			8
			9
			10
			11
			12
			13
			14
			15
			16

2. Press **Configure Differential Encoding**. This opens the differential state map editor. You are now prepared to create a custom differential encoding for the user-defined default 4QAM I/Q modulation.

Editing the Differential State Map

The editor functions in the same manner as the I/Q and FSK table editors (explained in “[Mapping Symbol Positions with the I/Q Table Editor](#)” on page 2 -15 and “[Building a Customized FSK Modulation with the FSK Table Editor](#)” on page 2 -22).

The following illustration shows the differential state map editor, along with the location of the data listing and the symbol table offset values entry area.

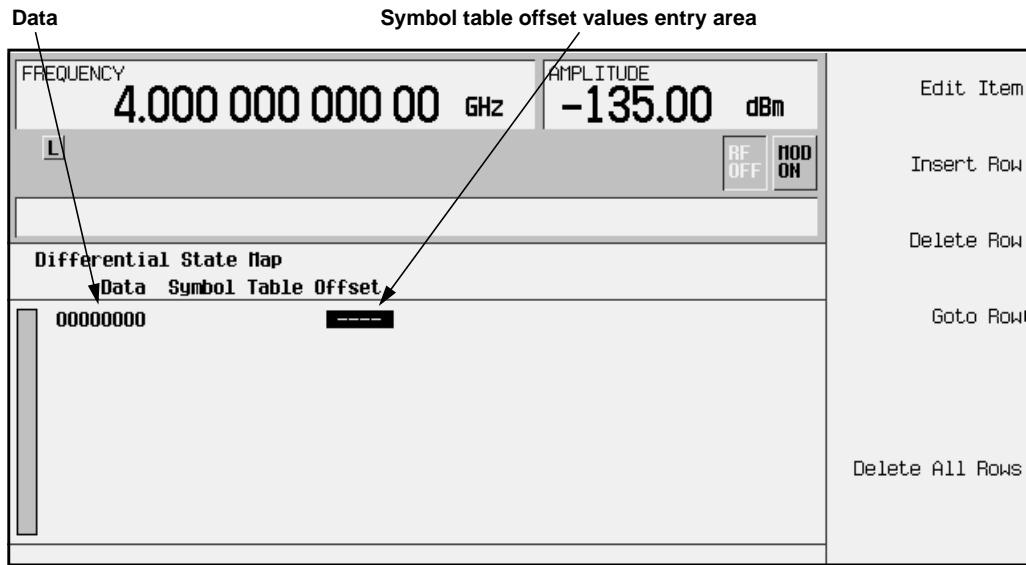

1. To encode the first symbol, add a symbol table offset of 1 by pressing **1 > Enter**. This will rotate *forward* through the state map by 1 value when a data value of 0 is modulated.

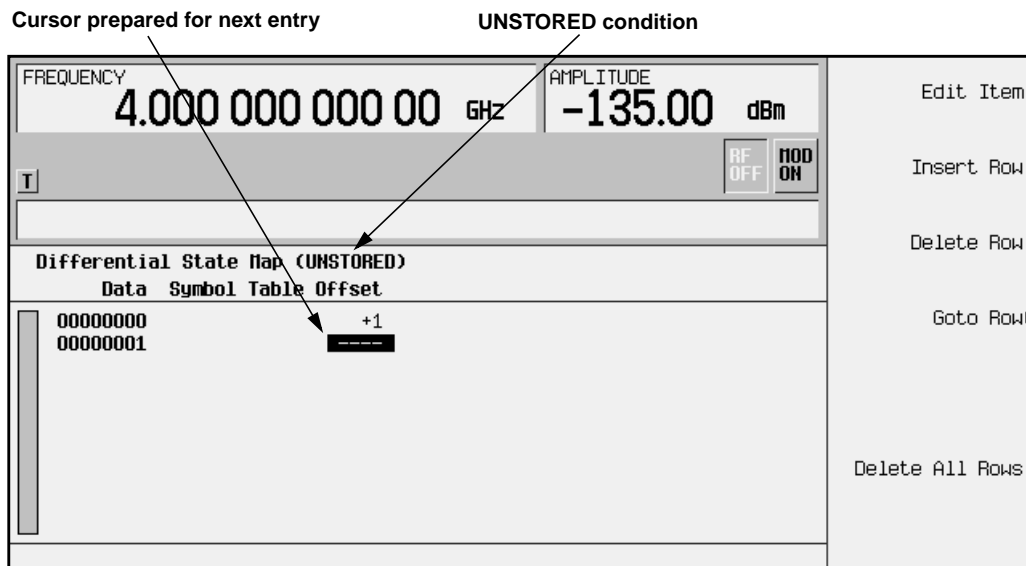

NOTE Notice that (UNSTORED) appears next to Differential State Map on the signal generator's display. Differential state maps are associated with the user-defined modulation for which they were created. In order to save a custom differential state map, you must store the user-defined modulation for which it was designed. Otherwise the symbol table offset data will be purged when you press the **Confirm Exit From Table Without Saving** softkey when exiting from the I/Q or FSK table editor.

- To encode the second symbol, add a symbol table offset of -1 by pressing +/- > 1 > Enter. This will rotate *backward* through the state map by 1 value when a data value of 1 is modulated.

NOTE At this point, the modulation has one bit per symbol. For the first two data values (00000000 and 00000001) only the last bits (the 0 and the 1, respectively) are significant.

- To encode the third symbol, add a symbol table offset of 2 by pressing 2 > Enter. This will rotate *forward* through the state map by 2 values when a data value of 10 is modulated.
- To encode the fourth symbol, add a symbol table offset of 0 by pressing 0 > Enter. This will *not* rotate through the state map when a data value of 11 is modulated.

NOTE At this point, the modulation has two bits per symbol. For the data values 00000000, 00000001, 00000010, 00000011, the symbol values are 00, 01, 10, and 11 respectively.

FREQUENCY		4.000 000 000 00 GHz		AMPLITUDE		-135.00 dBm		Edit Item
L				RF OFF		MOD ON		Insert Row
Differential State Map (UNSTORED)								Delete Row
	Data	Symbol Table	Offset					Goto Row▶
	00000000		+1					
	00000001		-1					
	00000010		+2					
	00000011		+0					
	00000100							Delete All Rows

- Press Return to go back to the I/Q table editor.

Applying the Custom Differential Encoding

To apply a custom differential encoding to a user-defined modulation, press **Differential Encoding Off On** until **On** is highlighted. The user-defined modulation will now be differentially encoded.

Mapping Symbol Positions with the I/Q Table Editor

In modulation schemes defined by standards (such as TDMA and CDMA), symbols appear in default positions in the I/Q plane. The I/Q table editor provided in Option UN8 enables you to do the following:

- Create a unique mapping of symbols.

You can create a mapping that is not supplied as a default. You can also create a non-standard mapping; this is often necessary for a proprietary modulation scheme.

- Change the position of one or more symbols in a standard mapping.

This is often done to test the sensitivity of a receiver, or to create a symbol mapping that is similar to a default.

The examples in this section provide information on how to create an I/Q map (on [page 2-16](#)), how to edit a default map (on [page 2-19](#)), how to globally change a value in an I/Q table (on [page 2-21](#)), and how to use a stored I/Q map (on [page 2-35](#)).

Four data bits define each symbol.

Active entry area

Unique I and/or Q levels
A map in I or Q is limited to 16 unique levels.
You can generate up to 256 unique states.

Define User I/Q softkey menu

I/Q Values Data	I Value	Q Value	Distinct Values
00000000	1.000000	1.000000	1
00000001	-1.000000	1.000000	2
00000010	-1.000000	-1.000000	3
00000011	1.000000	-1.000000	4
00000100			5
			6
			7
			8
			9
			10
			11
			12
			13
			14
			15
			16

I and Q values
Levels do not have to be symmetric.

Maximum of 16 unique levels

Load/Store
Load Default I/Q Map
Delete All Rows
Differential Encoding Off On
Configure Differential Encoding
Offset Q Off On
More (2 of 2)

Creating a Symbol Map

Use the following procedure to create and store a 4-symbol unbalanced QPSK.

Accessing the I/Q Table Editor

1. Preset the signal generator.
2. Press the front panel **Mode** key.
3. In the softkey menu, press **Real Time I/Q BaseBand** (if this softkey does not appear, go to step 4).
4. Display the I/Q table editor by pressing: **Custom > Modulation Type > Define User I/Q**
 Other Formats: **TDMA > desired format > More (1 of 2) > Modify Standard > Modulation Type > Define User I/Q**

The following illustration shows the I/Q table editor with data for a 4QAM I/Q map.

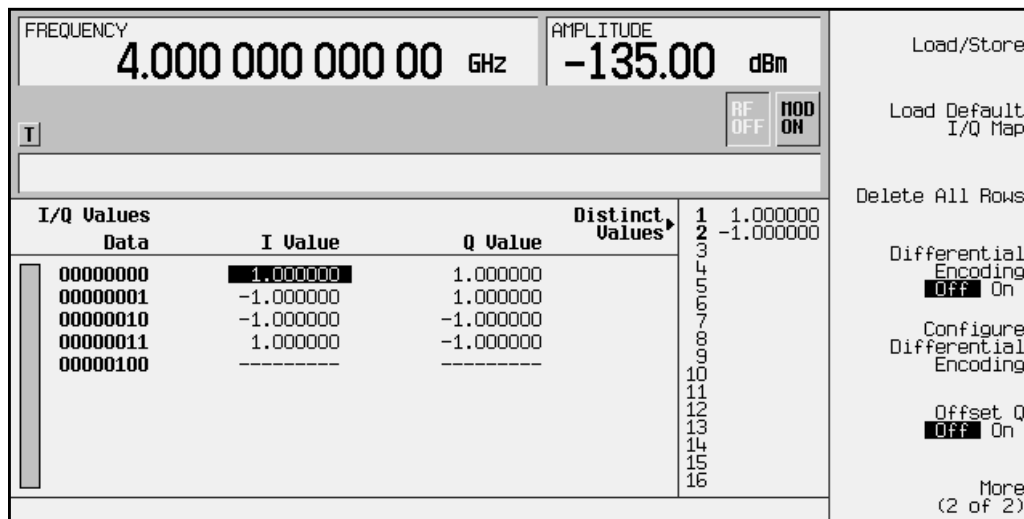

Clearing Data

When you create a new I/Q map (rather than editing existing data), it is often easier to start with an empty table. Use the following steps to clear existing data from the table editor.

1. Press **More (1 of 2)** to view the second page of softkeys.
2. Press **Delete All Rows > Confirm Delete of All Rows**. All data is removed from the table.
3. Press **More (2 of 2)** to return to the first page of softkeys.
4. Press **Display I/Q Map**. The data list is replaced by a blank I/Q state map.
5. To redisplay the list, press **Return**. As you enter data, you can toggle between the list and the map to visually check the entries.

Entering I and Q Values

Next you will enter the coordinates of each symbol. The position of a symbol is defined by a pair of values (one representing I and the other representing Q).

Symbol	Data Bits	I Value	Q Value
0	0000	0.500000	1.000000
1	0001	-0.500000	1.000000
2	0010	0.500000	-1.000000
3	0011	-0.500000	-1.000000

Both the 4QAM I/Q map shown on [page 2-16](#), and the map you create in this example have four symbols. Please note, however, that the 4QAM I/Q map uses only *two* unique values (-1.0 and 1.0) to create those symbols, while this example uses the following *four* unique values: 0.5, 1.0, -0.5, and -1.0. It is not the number of values that defines how many symbols a map has, but how those values are combined.

NOTE The number of bits per symbol can be expressed using the following formula. Because the equation is a ceiling function, if the value of x contains a fraction, x is rounded up to the next whole number.

$$x = \lceil \log_2(y) \rceil$$

Where x = bits per symbol, and y = the number of I/Q states.

The following figure summarizes the process of entering values in the I/Q table editor. Detailed steps begin on the next page.

The screenshot shows the I/Q Table Editor interface. At the top, it displays 'FREQUENCY 4.000 000 000 00 GHz' and 'AMPLITUDE -135.00 dBm'. Below this, there are 'RF OFF' and 'MOD ON' buttons. The 'I' value is currently set to '0.5'. The main table is titled 'I/Q Values (UNSTORED)' and has columns for 'Data', 'I Value', and 'Q Value'. The 'Data' column contains '00000000'. The 'I Value' and 'Q Value' columns are currently empty, indicated by dashed lines. To the right of the table is a 'Distinct Values' list, which is currently empty. An 'Enter' button is located at the top right of the interface. Three numbered instructions with arrows point to specific parts of the interface: 1. 'Use the arrow keys to highlight where you wish to enter a value.' points to the 'I Value' field. 2. 'Use the keypad to enter the desired value.' points to the '0.5' in the 'I Value' field. 3. 'Press Enter to accept the value.' points to the 'Enter' button. A note on the right says 'Because there are no values in an empty table, this list is empty.' pointing to the 'Distinct Values' list.

1. Note that the entry under **I Value** is highlighted. Use the numeric keypad to type the first I value from the table on [page 2-17](#). You do not have to type the leading zero, or the zeros that follow the number 5.

As you press the keys, the numbers display in the active entry area (if you make a mistake, use the backspace key and then retype).

2. To accept the value, press the **Enter** softkey. Note that the I value updates, the highlight moves to the first **Q** entry (and provides a default value of 0), and an empty row of data appears below the first row.

Also note that 0.000000 appears as the first entry in the list of Distinct Values, and that 0.500000 appears as the second entry.

NOTE The maximum number of distinct (unique) values that can appear in any I/Q map is 16. This is *not* the maximum number of I/Q entries; this is simply the maximum number of distinct values that you can use to create the entries. For example, if you load the default 256QAM map, you will see that 16 distinct values have been used to create far more than 16 I/Q entries.

3. For the first **Q Value**, type 1, then press **Enter**. The **Q** value updates, and the highlight moves to the second **I** value. Now 0.500000 and 1.000000 are listed as the distinct values.
4. Enter the remaining **I** and **Q** values. Remember that you can view the I/Q map at any time (using the **Display I/Q Map** softkey, as described in [“Clearing Data”](#) on page 2-16). The figure to the right shows a completed constellation.

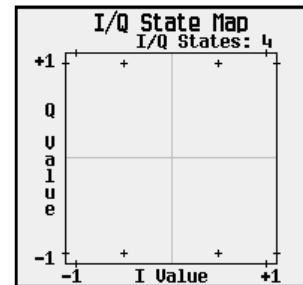

Storing the I/Q Map to Memory

Now that you have created a customized I/Q map, you can save it for future use. See [“Storing User-Defined Files to Memory”](#) on page 2-33.

Moving an I/Q Symbol

You can manipulate symbol locations to simulate magnitude and phase errors. In this example, you will edit a 4QAM constellation to move one symbol closer to the origin.

Loading the 4QAM I/Q Map

1. Preset the signal generator, then press the front panel **Mode** key.
2. In the softkey menu, press **Real Time I/Q BaseBand** (if it appears) > **Custom** > **Modulation Type** > **Define User I/Q** > **More (1 of 2)** > **Load Default I/Q Map** > **QAM** > **4QAM**

Other Formats: **Real Time I/Q BaseBand** (if it appears) > **TDMA** > *desired format* > **More (1 of 2)** > **Modify Standard** > **Modulation Type** > **Define User I/Q** > **More (1 of 2)** > **Load Default I/Q Map** > **QAM** > **4QAM**

The I/Q table editor displays the data for the 4QAM I/Q map.

3. Press **More (2 of 2)** to return to the first page of softkeys.

The following illustration of the I/Q table editor shows the data for a 4QAM I/Q map.

The screenshot shows the I/Q Table Editor interface. At the top, it displays 'FREQUENCY 4.000 000 000 00 GHz' and 'AMPLITUDE -135.00 dBm'. Below this is a table with columns for 'I/Q Values Data', 'I Value', 'Q Value', and 'Distinct Values'. The table contains five rows of data. To the right of the table are several softkey options: 'Load/Store', 'Load Default I/Q Map', 'Delete All Rows', 'Differential Encoding Off On', 'Configure Differential Encoding', 'Offset Q Off On', and 'More (2 of 2)'.

I/Q Values Data	I Value	Q Value	Distinct Values
00000000	1.000000	1.000000	1 1.000000
00000001	-1.000000	1.000000	2 -1.000000
00000010	-1.000000	-1.000000	3
00000011	1.000000	-1.000000	4
00000100	-----	-----	5

4. Remember that you can view the I/Q map at any time (using the **Display I/Q Map** softkey, as described in “[Clearing Data](#)” on page 2 -16). The figure to the right shows a 4QAM I/Q constellation.

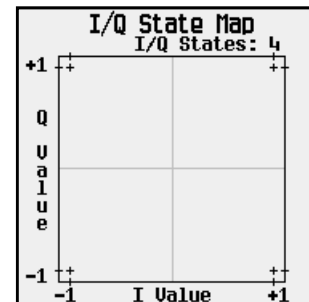

Editing I and Q Values

The following figure summarizes the process of editing values in the I/Q table editor. Detailed steps begin after the figure.

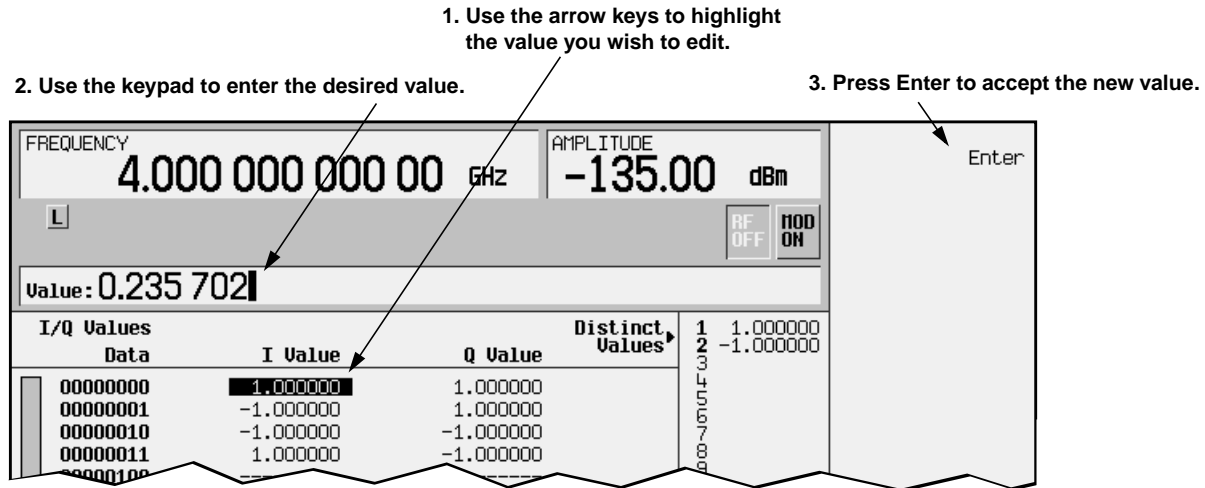

1. Note that the first I value is highlighted. Using the numeric keypad, type 0.235702.

As you press the keys, the numbers display in the active entry area (if you make a mistake, use the backspace key and then retype).

2. To accept the value, press the **Enter** softkey. Note that the I value updates, and the highlight moves to the first Q entry.
3. For the first Q entry, enter 0.235702 and press **Enter**.
4. In the softkey menu, press **Display I/Q Map**. Note that one symbol has moved, as shown in the following figure.

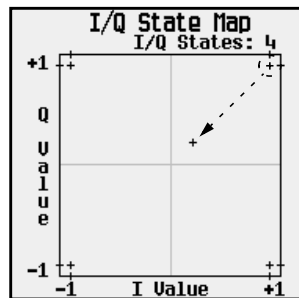

Storing the modified I/Q Map to Memory

Now that you have modified the I/Q map, you can save it for future use. See [“Storing User-Defined Files to Memory”](#) on page 2-33.

Globally Replacing an I/Q Value

When you want to change an I/Q value throughout the entire table, you can change the value once and have all occurrences of that value change to the new value. In this example, you will use the **Globally Replace Selected Item** command to globally replace I/Q values.

NOTE When using the **Globally Replace Selected Item** command, be sure that you want *all* occurrences of the selected value changed. Also, consider the order in which you change values. For example, if you want to change all current 0.5 values to 1.0, and all current 1.0 values to -0.75 , change the 1.0 values first, or all values will end up as -0.75 .

1. Load a 4QAM I/Q map into the table editor as described on [page 2-19](#).
2. Select any occurrence of the value 1.000000, then select the softkey **Globally Replace Selected Item**.
3. Using the numeric keypad, type 0.5, then press the **Enter** softkey.
Note that all entries in the table that were originally 1.000000 now read 0.500000.
4. Select any occurrence of the value -1.000000 , then press the softkey **Globally Replace Selected Item**.
5. Using the numeric keypad, type -0.5 , then press the **Enter** softkey.
Note that all entries in the table that were originally -1.000000 now read -0.500000 .
6. In the softkey menu, press **Display I/Q Map**. Note that you have moved all of the symbols, as shown below.

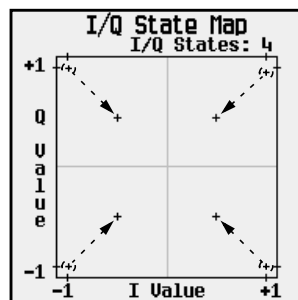

Storing the I/Q Map to Memory

As described in “[Storing User-Defined Files to Memory](#)” on page 2-33, you can save this modified map for future use (**Load/Store > Store To File**).

Building a Customized FSK Modulation with the FSK Table Editor

Use this procedure to create, store, and apply a customized, continuous 4-level FSK signal. You will learn to do the following:

- Choose the Define User FSK setting
- Create a unique file of frequency deviations
- Load and modify a default FSK pattern

Choosing the Define User FSK Setting

1. Preset the signal generator to normal preset conditions.
2. Press the front panel **Mode** hardkey. (If you have multiple options installed in your signal generator, press the **Real Time I/Q BaseBand** softkey to select Option UN8.)
3. Choose the desired modulation and select the Define User FSK menu:

Custom: **Custom** > **Modulation Type** > **Define User FSK**

Other Formats: **TDMA** > *desired format* > **More (1 of 2)** > **Modify Standard** > **Modulation Type** > **Define User FSK**

4. You will see a **Frequency Values** table with **Data** in the first column and **Freq. Deviation** in the second column. The following illustration of the FSK table editor shows the data for an 8-level FSK modulation.

Active entry area

Frequency values

Define User FSK softkey menu

Data	Freq. Deviation
0000	-400.0 Hz
0001	-285.7 Hz
0010	-171.4 Hz
0011	-57.1 Hz
0100	400.0 Hz
0101	285.7 Hz
0110	171.4 Hz
0111	57.1 Hz
1000	-----

Creating a Unique FSK File of Frequency Deviations

There are two ways to create a custom FSK file. You can either define the frequency deviations using completely original data (see "Using Original Data" below), or you can load and modify a default FSK pattern (see "Modifying a Default FSK Pattern" on page 2-24).

Using Original Data

Use the following instructions to create an example of an APCO25 C4FM customized continuous 4-level FSK signal with two bits per symbol.

NOTE The number of bits per symbol can be expressed using the following formula. Because the equation is a ceiling function, if the value of x contains a fraction, x is rounded up to the next whole number.

$$x = \lceil \log_2(y) \rceil$$

Where x = bits per symbol, and y = the number of frequencies.

When you create new frequency values (rather than edit existing data), it is often easier to start with an empty table. To clear the existing frequency values from within the Define User FSK menu, press **More (1 of 2) > Delete All Rows > Confirm Delete Of All Rows**.

The following figure defines the areas of the display. As you enter frequency deviation values, the numbers will display in the active entry area (if you make a mistake, use the backspace key and then retype). Follow the steps below:

1. For the first frequency deviation value, enter 600 Hz. Note that each time you enter a value, the Data column increments to the next binary number, up to a total of 16 data values (from binary 0000 to binary 1111).

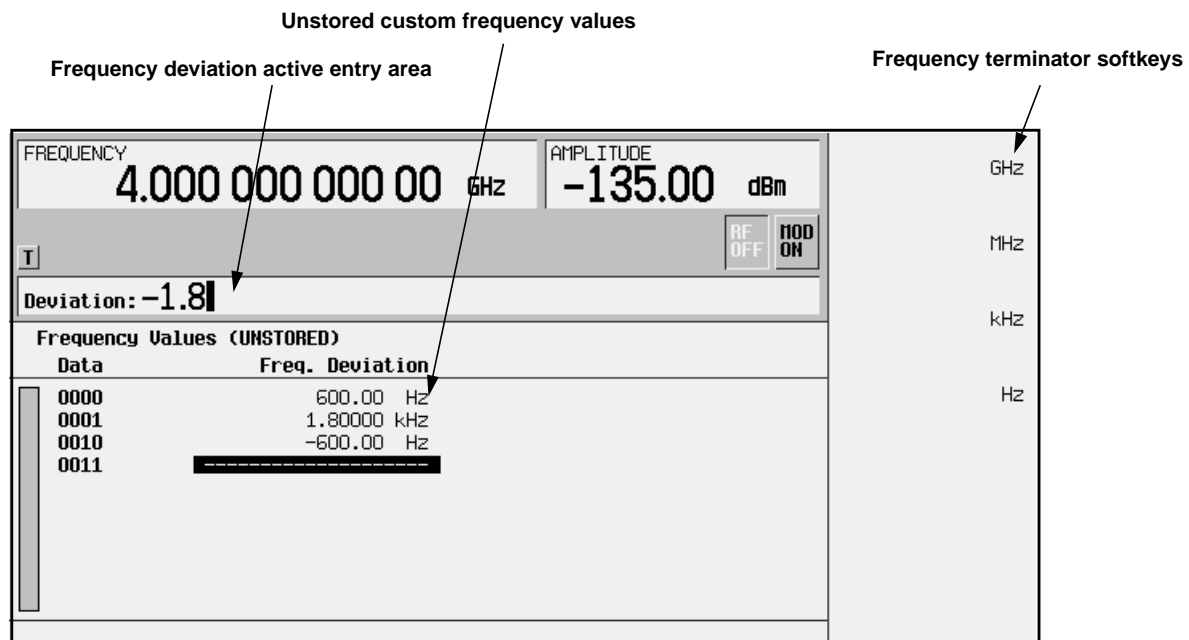

2. Enter the remaining frequency deviation values:

- Data row 0001: +1.8 kHz
- Data row 0010: -600 Hz
- Data row 0011: -1.8 kHz

Storing the Custom FSK Modulation to a File

You have created an unstored file of frequency deviation values for a custom 4-level FSK file. To learn how to store the file, see “[Storing User-Defined Files to Memory](#)” on page 2-33.

Modifying a Default FSK Pattern

The basic steps in adding errors to a default modulation:

- Load the default synchronous FSK modulation.
 - Designate a frequency deviation value.
 - Choose an FSK pattern.
1. From the Define User FSK softkey menu, press **More (1 of 2) > Load Default FSK**.
 2. Enter 1.8 kHz as the frequency deviation.

You will see **1.8000 kHz** displayed in the **Freq:** active entry area of the display, and in bold under the **Freq Dev** softkey. See the following figure.

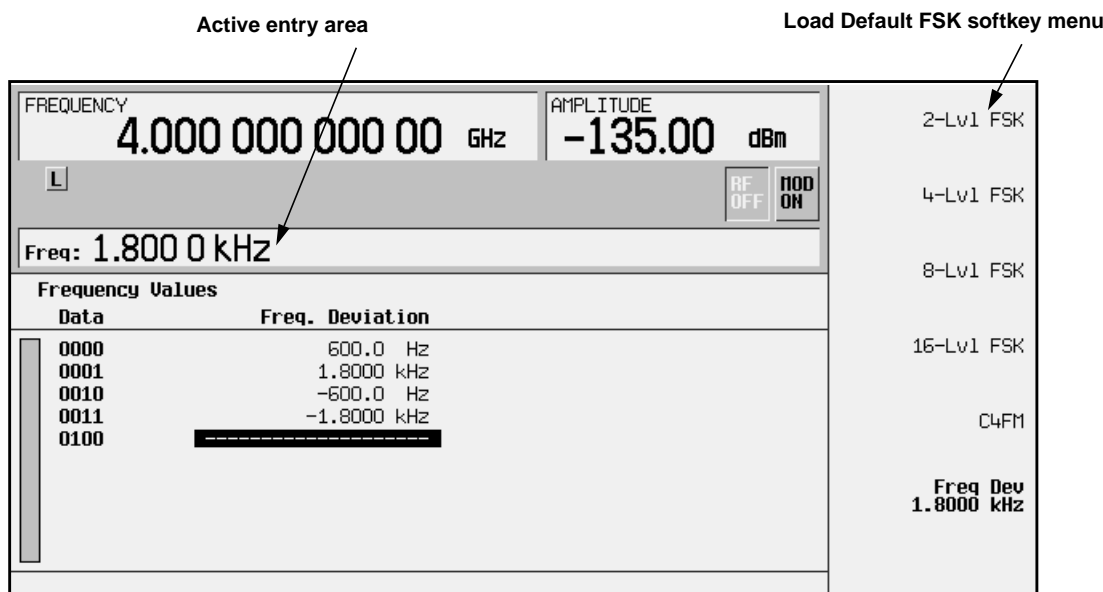

- Press the **4-Lvl FSK** softkey. You will see the FSK table editor with the default Frequency Values displayed. See the following figure.

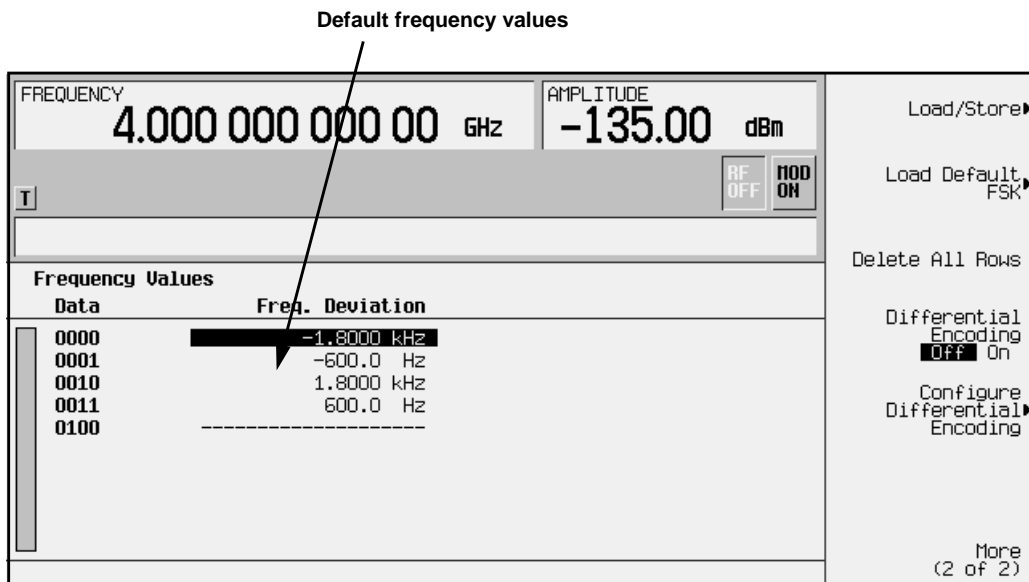

- Highlight the frequency value for data row 0000, then modify the first frequency deviation value as follows:

- Press **More (2 of 2) > Edit Item**.
- Change the value to -1.810 kHz.
- Notice that the highlight bar moves to data row 0001.

- Enter the following frequency deviation values:

- Data row 0001: -590 Hz
- Data row 0010: +1.805 kHz
- Data row 0011: +610 Hz

You have created an unstored file of frequency deviation values for your custom 4-level FSK file. To learn how to store the file, see [“Storing User-Defined Files to Memory”](#) on page 2-33.

Storing the Custom FSK Modulation to a File

Now that you have created a customized FSK modulation that you can save for future use. See [“Storing User-Defined Files to Memory”](#) on page 2-33.

Creating User-Defined FIR Filters

You can use the FIR table editor to create a customized FIR filter either by entering coefficient values, or by modifying the values of an existing filter (see [page 2-30](#)).

Creating a User-Defined FIR Filter by Entering Values

Use this procedure to create and store an 8-symbol, windowed sinc function filter with an oversample ratio of 4.

Accessing the Table Editor

1. Preset the signal generator, then press the front panel **Mode** key.
2. In the softkey menu, press **Real Time I/Q BaseBand** (if it appears) > **Custom** > **Filter** > **Define User FIR**

Other Formats: **Real Time I/Q BaseBand** (if it appears) > **TDMA** > *desired format* > **More (1 of 2)** > **Modify Standard** > **Filter** > **Define User FIR**

The FIR table editor is displayed, as shown in the following illustration.

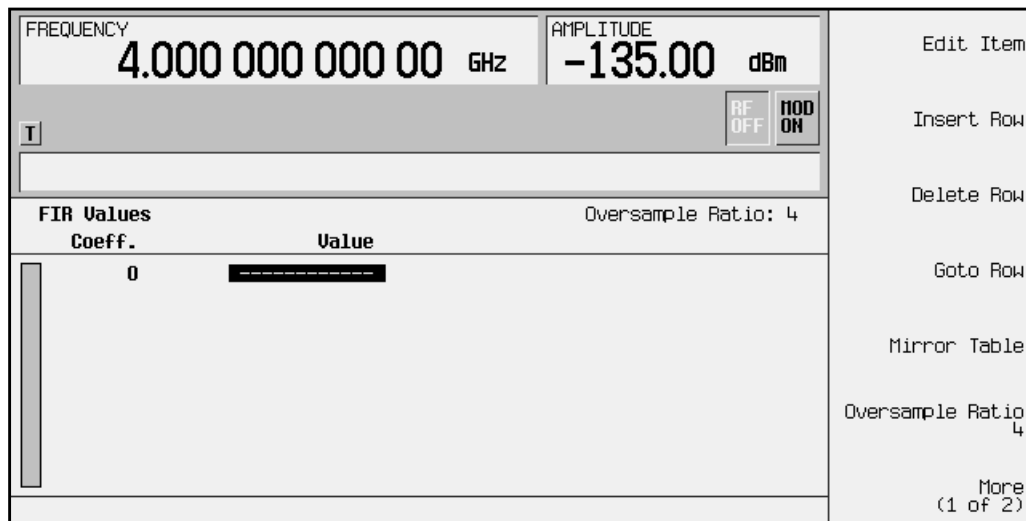

Entering the Coefficient Values

The FIR table editor creates a filter from values that you provide.

NOTE In this example, the values you enter are listed after step 3.

1. When you create new coefficient values (rather than edit existing data), it is often easier to start with an empty table. If there are existing coefficient values in the table editor, press **More (1 of 2)** > **Delete all Rows** > **Confirm Delete Of All Rows** to clear the table.

- Note that the coefficient 0 Value field is highlighted. Use the numeric keypad to type the first value from the list. As you press the numeric keys, the numbers appear in the active entry area. (If you make a mistake, you can correct it using the backspace key.)

Terminate the entry by pressing the **Enter** softkey. Note that the value for coefficient 0 is now displayed in the Value field and a second row is automatically displayed with the Value field highlighted. (The following illustration shows the FIR table editor at this point in the process.)

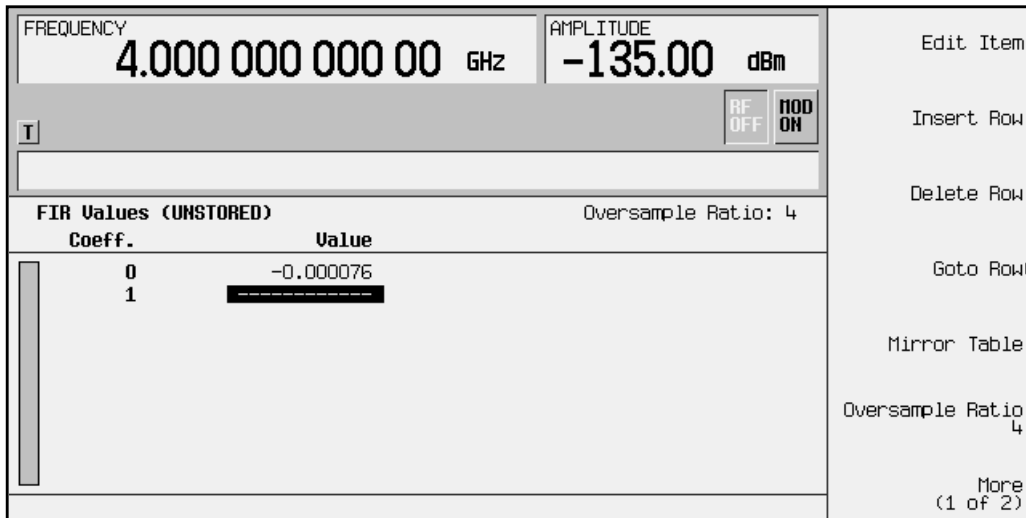

- Continue entering the coefficient values until all 16 are complete.

Coefficient	Value
0	-0.000076
1	-0.001747
2	-0.005144
3	-0.004424
4	0.007745
5	0.029610
6	0.043940
7	0.025852

Coefficient	Value
8	-0.035667
9	-0.116753
10	-0.157348
11	-0.088484
12	0.123414
13	0.442748
14	0.767329
15	0.972149

Duplicating the First 16 Coefficients using Mirror Table

In a windowed sinc function filter, the second half of the coefficients are identical to the first half in reverse order. The signal generator provides a mirror table function that automatically duplicates the existing coefficient values in the reverse order.

1. Press the **Mirror Table** softkey. The last 16 coefficients are automatically generated and the first of these coefficients (number 16) is highlighted. The following illustration shows the display at this point in the process.

FIR Values (UNSTORED)		Oversample Ratio: 4	Edit Item
Coeff.		Value	Insert Row
10	-0.157348		Delete Row
11	-0.088484		Goto Row
12	0.123414		Mirror Table
13	0.442748		Oversample Ratio
14	0.767329		4
15	0.972149		More
16	0.972149		(1 of 2)
17	0.767329		
18	0.442748		
19	0.123414		

Setting the Oversample Ratio

The oversample ratio (OSR) is the number of filter taps per symbol. Acceptable values range from 1 through 32, where the maximum combination of symbols and oversampling ratio allowed by the table editor is 1024. The instrument hardware, however, is actually limited to 32 symbols, an oversample ratio between 4 and 16, and 256 coefficients. If you enter more than 256 coefficients (but no more than 32 symbols) the instrument will resample to filter within the OSR limits. If the oversample ratio is different from the internal, optimally selected one, then the filter will be resampled to the most optimal oversample ratio.

For this example, the desired OSR is 4, which is the default, so no action is necessary.

Displaying a Graphical Representation of the Filter

The signal generator has the capability of graphically displaying the filter in both time and frequency dimensions.

1. To view the filter frequency response (calculated using a fast Fourier transform), press **More (1 of 2) > Display FFT**. The following graph will be displayed:

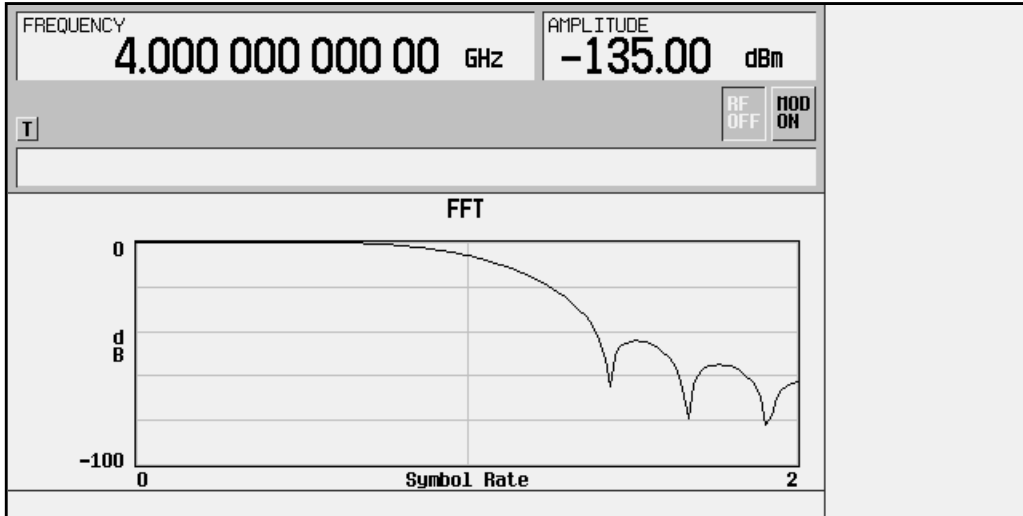

2. To return to the menu keys, press **Return**.
3. Display the filter impulse response in time by pressing **Display Impulse Response**. The following graph will be displayed:

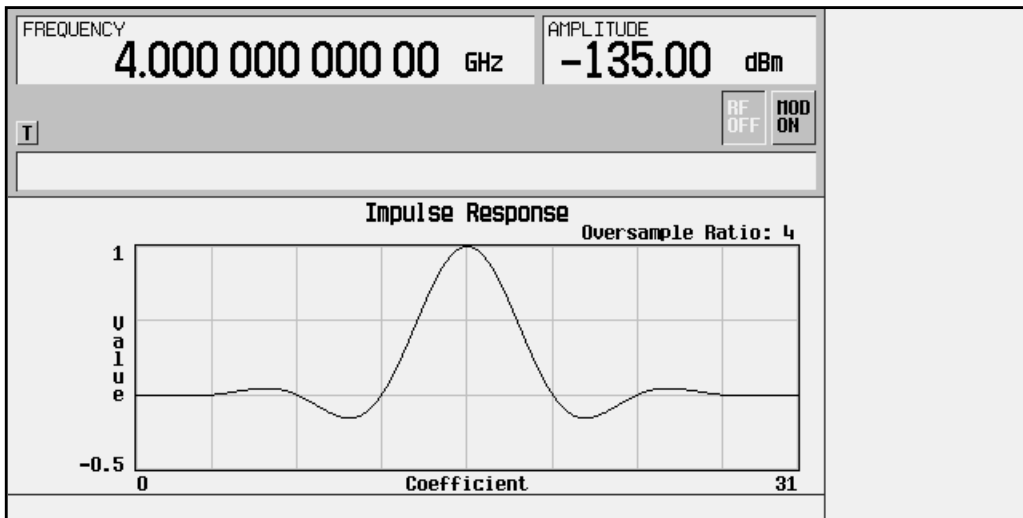

4. To return to the menu keys, press **Return**.

Modifying an Existing FIR Filter with the FIR Table Editor

FIR filters stored in signal generator memory can easily be modified using the FIR table editor. You can load the FIR table editor with coefficient values from user-defined FIR files stored in the signal generator's memory, or from one of the default FIR filters. Then you can modify the values and store the new file. In this example, you load the FIR table editor with the values for a default Gaussian filter and then modify it.

Loading the Default Gaussian FIR File

1. Preset the signal generator to normal preset conditions.
2. Press the front panel **Mode** key.
3. In the softkey menu, press **Real Time I/Q BaseBand** (if it appears) > **TDMA** > **EDGE (Rev 8.3.0 Release 1999)** > **More (1 of 2)** > **Modify Standard** > **Filter** > **Define User FIR** > **More (1 of 2)** > **Load Default FIR** > **Gaussian**
4. Set the filter BbT to 0.300 (if **Filter BbT** is not already set to this value): Press **Filter BbT** and rotate the front panel knob until 0.300 is displayed.
5. Set the number of filter symbols to 8 (if **Filter Symbols** is not already set to this value): Press **Filter Symbols** and rotate the front panel knob until 8 is displayed.
6. Press **Generate**. The FIR table editor should now contain the coefficient values for the specified Gaussian filter.

NOTE The actual oversample ratio during modulation is automatically selected by the instrument. A value between 4 and 16 is chosen dependent on the symbol rate, the number of bits per symbol of the modulation type, and the number of symbols.

7. Press **Display FFT** for a graphic representation of the filters frequency response as shown on the following page.
8. To return to the menu keys, press **Return**.

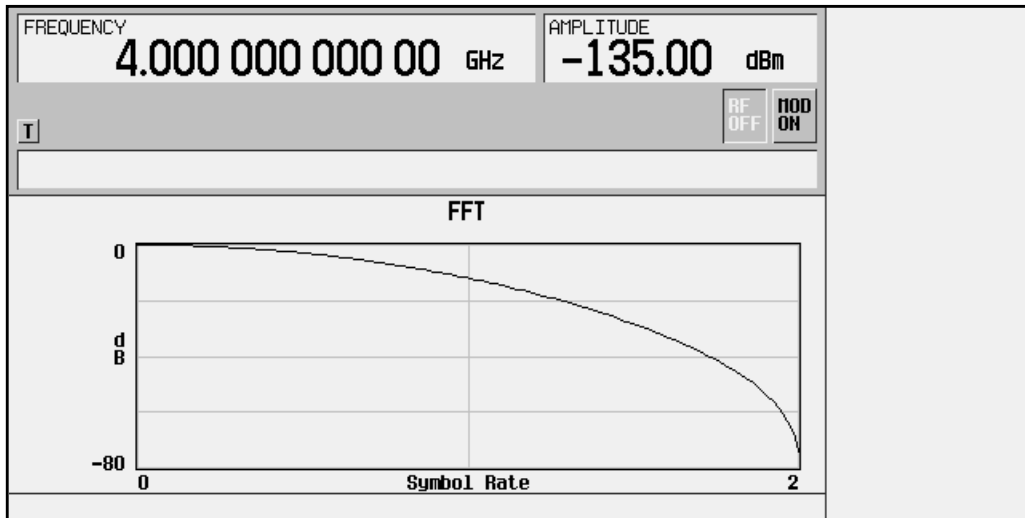

Modifying the Coefficients

1. The value for coefficient 0 should be highlighted. Use the front panel knob to scroll down until coefficient 15 is highlighted.
2. Press **0** > **Enter** to change the value of the coefficient to 0.
3. Press **Display FFT** to see the effects of the change:

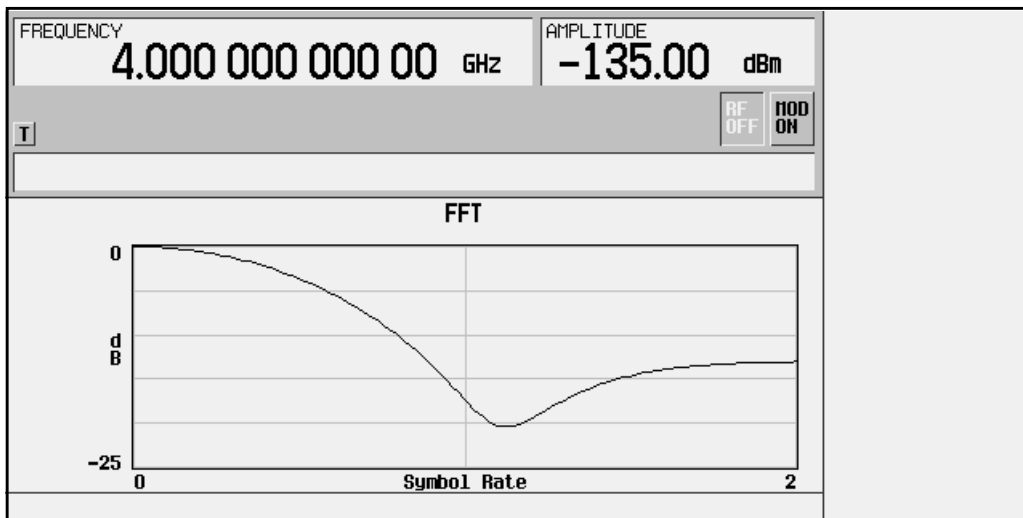

Notice that the graphic display can provide a useful troubleshooting tool (in this case indicating a missing coefficient value for a proper Gaussian response).

4. To return to the menu keys, press **Return**.
5. In addition to changing existing values, you can also insert and delete rows of coefficients and change the oversample ratio. Press **More (2 of 2)** to access these softkeys.

Using Windowing to Modify Default FIR Filters

1. Access the Load Default FIR menu again and select the Nyquist filter.
2. Add Kaiser windowing by pressing **Window > Kaiser**.
3. The Beta factor is automatically activated when the Kaiser windowing function is selected. The default value provides a good compromise for optimizing out of band performance (ACP) without seriously compromising passband performance (EVM). For this example, increase the Beta factor to 8 which will further improve ACP.
4. Press **Return > Return > Generate**. The FIR table editor should now contain the coefficient values for the specified Gaussian filter with Kaiser windowing.
5. Press **Display Impulse Response** for a graphic representation of the filter impulse response as shown here:

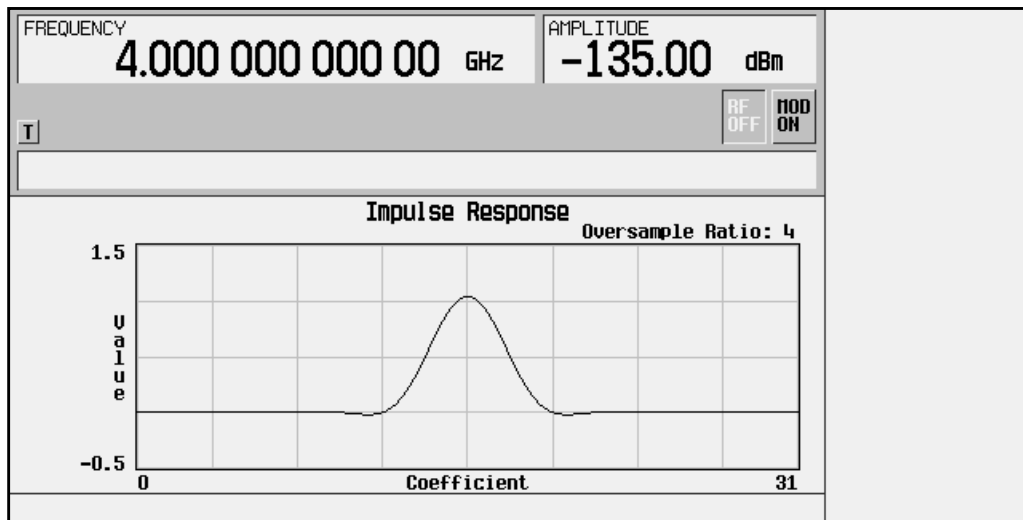

6. To return to the menu keys, press **Return**.

Storing the Filter to Memory

See “[Storing User-Defined Files to Memory](#)” on page 2-33.

Storing User-Defined Files to Memory

While the setup of each type of file may be different, the process of storing a configuration for later recall and use is the same: use the **Store To File** softkey to store the current configuration to a file in non-volatile memory.

When the contents of a table editor has not been stored, (UNSTORED) appears as shown in the following example.

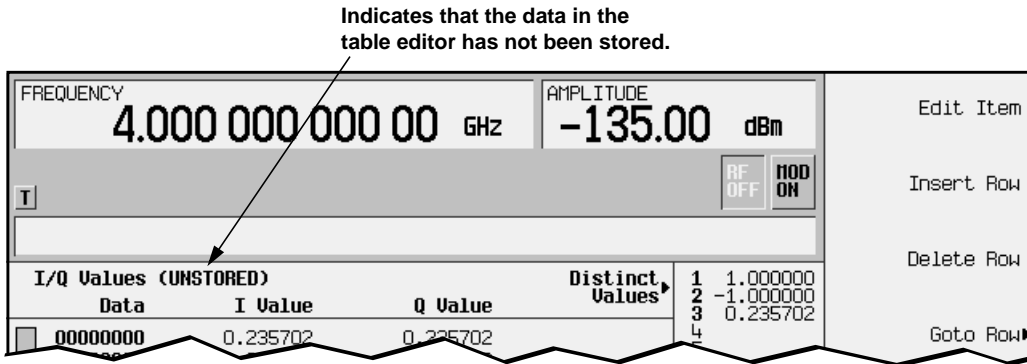

If you try to exit a table editor without storing, the signal generator displays the softkey:

Confirm Exit From Table Without Saving

To exit *without* saving the table, select the softkey. If you do *not* want to exit, press **Return**.

1. In the softkey menu, press **More 1 of 2 > Load/Store**. A catalog of files appears, which lists stored files, and amount of memory both used and available (in bytes).
2. Press **Store To File**. A softkey menu appears that contains letters and symbols that you can use to name the file.
3. If there are already files in the catalog, the first file is selected, and its name appears in the active entry area. If an existing file is selected, press the **Editing Keys** softkey, then select **Clear Text**. The previous page of softkeys returns, and only a cursor appears in the active entry area following the Store to: text.

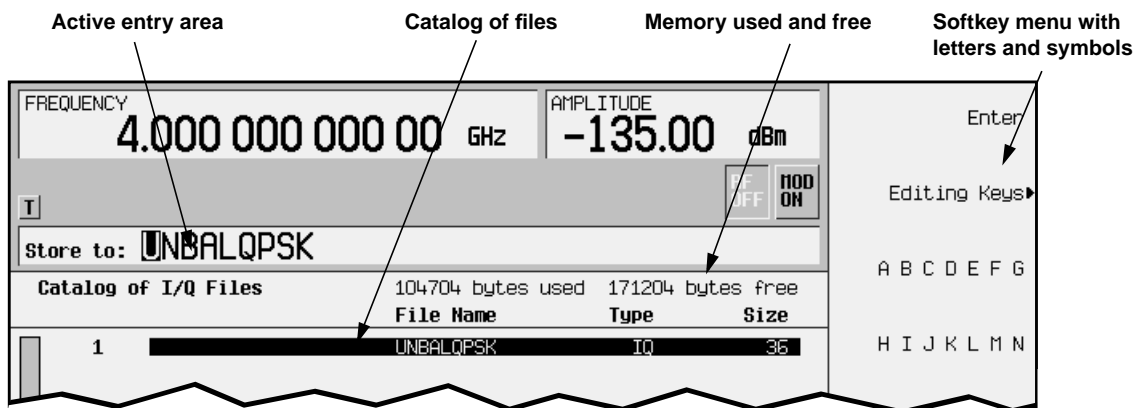

- To name the file, press the softkey containing the desired character, then select the softkey with that character from the subsequent menu. For example, to begin naming the file NEW4QAM, first press the HIJKLMN softkey, and then press the N softkey.

Note that N is displayed in the active entry area following the Store to: text. Continue entering the characters for the file name until NEW4QAM is displayed in the active entry area (use the numeric keypad for the number 4).

- When the file name is complete, press Enter. The following figure shows the results of saving an I/Q file.

FREQUENCY		4.000 000 000 00 GHz		AMPLITUDE		-135.00 dBm		Load From Selected File Store To File Delete File Goto Row Page Up Page Down
I				RF OFF		MOD ON		
Catalog of I/Q Files		104768 bytes used		171140 bytes free				
		File Name		Type		Size		
1		NEW4QAM		IQ		32		
2		UNBALQPSK		IQ		36		

Selecting Stored Files

Once you have created and stored a customized file, you can use that information with a customized modulation state, as described in this section.

Applying a Stored I/Q Map

1. Press the front panel **Mode** key.
2. In the softkey menu, press **Real Time I/Q BaseBand** (if it appears) > **Custom**
Other Formats: **Real Time I/Q BaseBand** (if it appears) > **TDMA** > *desired format* > **More (1 of 2)** > **Modify Standard**
3. To display the catalog of stored I/Q files, press **Modulation Type** > **Select** > **User I/Q**.
4. Highlight the file you want to use, then press **Load From Selected File**.

The information from the file is loaded, and User I/Q is displayed as the Mod Type. Also note that (<file name>@IQ) appears below the **Select** softkey, as shown below.

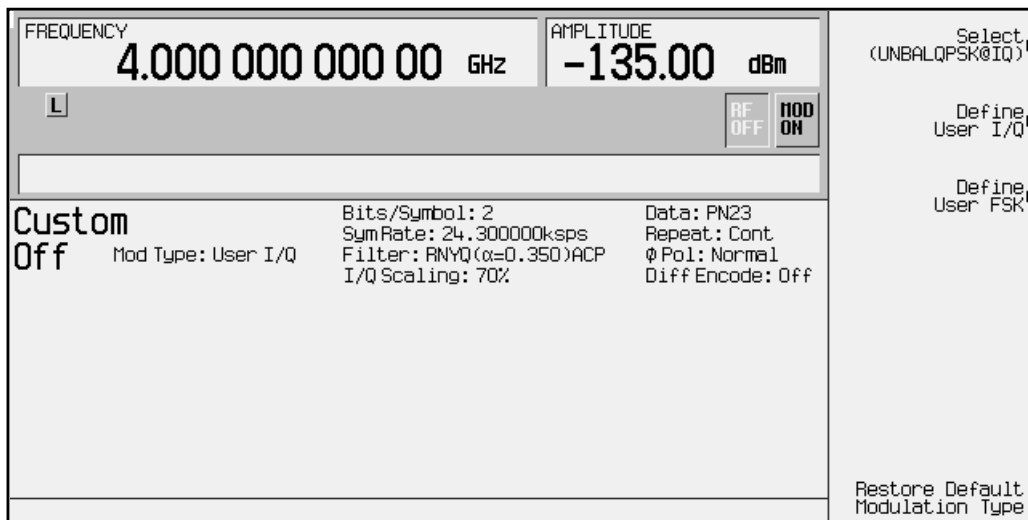

Applying a User-Defined FIR Filter

1. Preset the signal generator to normal preset conditions.
2. Press the front panel **Mode** key.
3. In the softkey menu, press **Real Time I/Q BaseBand** (if it appears) > **Custom**
 Other Formats: **Real Time I/Q BaseBand** (if it appears) > **TDMA** > *desired format* > **More (1 of 2)** > **Modify Standard**
4. To display the catalog of FIR files, press **Filter** > **Select** > **User FIR**. The following illustration shows an example of the catalog.

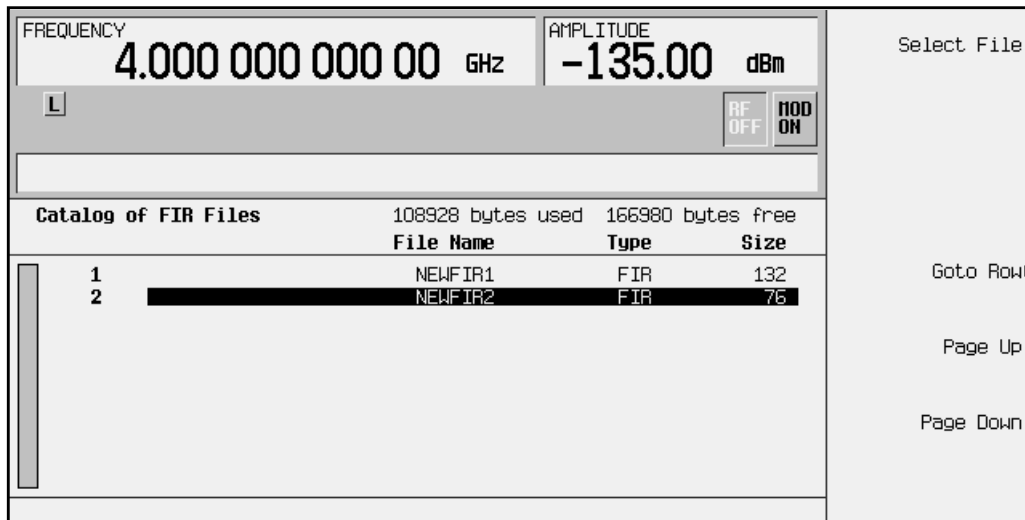

In this example there are two FIR files listed: NEWFIR1, and NEWFIR2.

5. Press the arrow keys until the desired filter is highlighted. The front panel knob or the **GoTo Row** softkey can also be used to highlight filters. NEWFIR2 is highlighted in the above example.
6. Press **Select File**. The highlighted filter is now selected for use in your custom modulation state.

The name of the selected filter appears below the **Select File** softkey (at the top and right). In the Filter field, near the center of the display, **User FIR** is shown to indicate that a user-defined FIR filter has been selected.

Once you have set the other modulation parameters to your satisfaction, turn on the modulation and the RF output and your user-defined filter is in use.

NOTE The actual oversample ratio during modulation is automatically selected by the instrument. A value between 4 and 16 is chosen dependent on the symbol rate, the number of bits per symbol of the modulation type, and the number of symbols.

Selecting a Custom FSK File

Once you have created and stored a custom FSK modulation to a file, you can apply its unique characteristics for your custom modulation by selecting it:

1. Preset the signal generator to normal preset conditions.
2. Press the **Mode** hardkey. (If you have multiple options installed in your signal generator, press the **Real Time I/Q BaseBand** softkey to select Option UN8.)
3. Press **Custom > Modulation Type > Select > User FSK**

Other Formats: **TDMA > *desired format* > More (1 of 2) > Modify Standard > Modulation Type > Select > User FSK**

The Catalog of FSK Files appears.

4. Highlight the desired file.
5. Press **Select File**.

The display returns to the Modulation Type menu. Notice that the name of the selected file is displayed under the **Select** softkey in the Modulation Type menu, and Mod Type: User FSK is displayed on the front panel display.

Using the Bit File Editor

The Bit File Editor enables you to create user files from scratch or manipulate user files downloaded from a remote computer. In turn, the files can be used as the transmitted data within a framed TDMA modulation, transmitted as a continuous unframed data stream according to the protocol of the active TDMA format, or transmitted as the data for a custom modulation format.

For information regarding data transfer between a system controller and the signal generator, see the remote data transfer guide.

Creating a User File

The Bit File Editor can be used to create custom data for a user file. Use the following procedure to create a user file for a custom modulation format.

1. Press the front panel **Preset** hardkey.
2. Press the front panel **Mode** hardkey.
3. In the softkey menu, press **Custom > Data > User File > Create File**. This opens the Bit File Editor.

NOTE When you create new file, the default name appears as UNTITLED, or UNTITLED1, and so forth. This prevents overwriting previous files.

The Bit File Editor contains three columns: Offset, Binary Data, and Hex Data. There are also cursor position and file name indicators, as shown in the following figure.

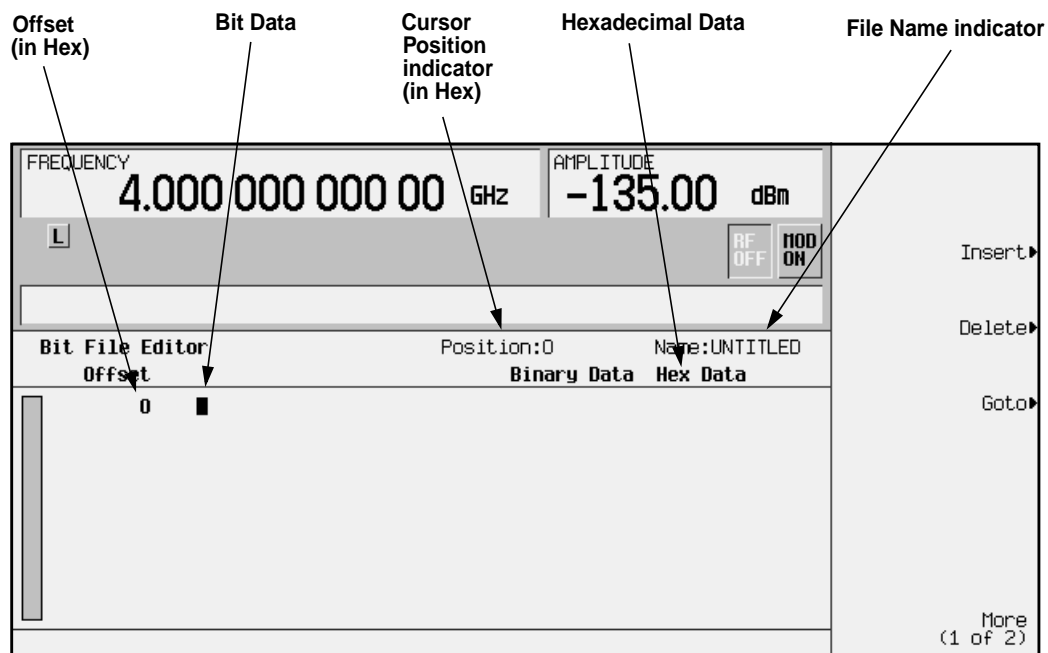

- Enter bit data using the numeric keypad. Bit data is entered into the table editor in 1-bit format. The current hexadecimal value of the binary data is shown in the Hex Data column, and the cursor position (in hexadecimal) is shown in the Position indicator. See the following figure.

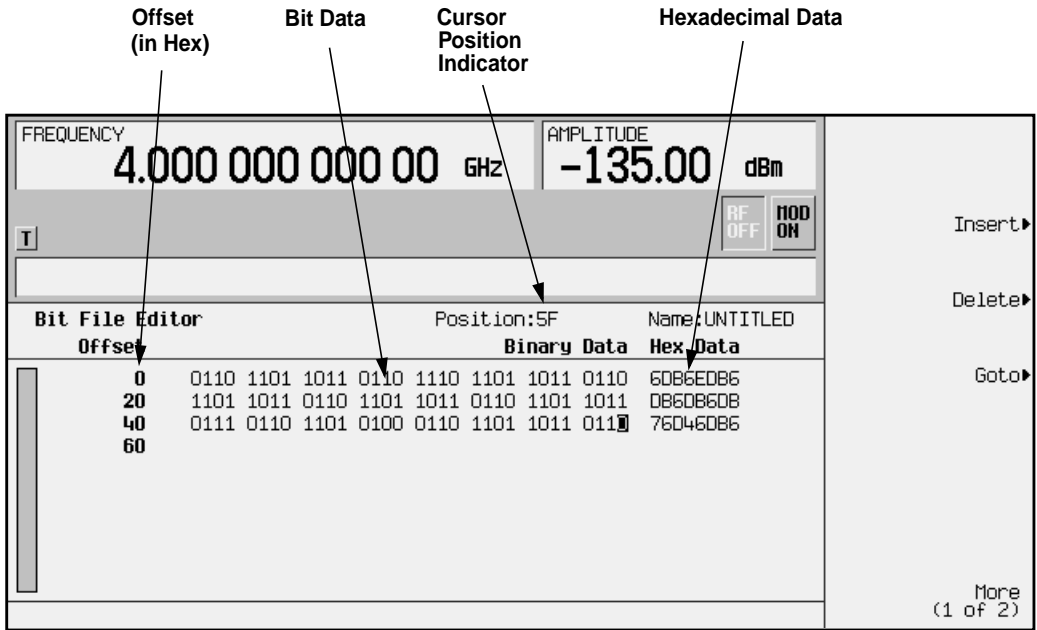

- To copy a file to a file with a new name, or to rename an existing file, press **More (1 of 2) > Rename or Copy**. This opens the file naming menu, as seen in the following figure. To clear the name UNTITLED, press **Editing Keys > Clear Text**.

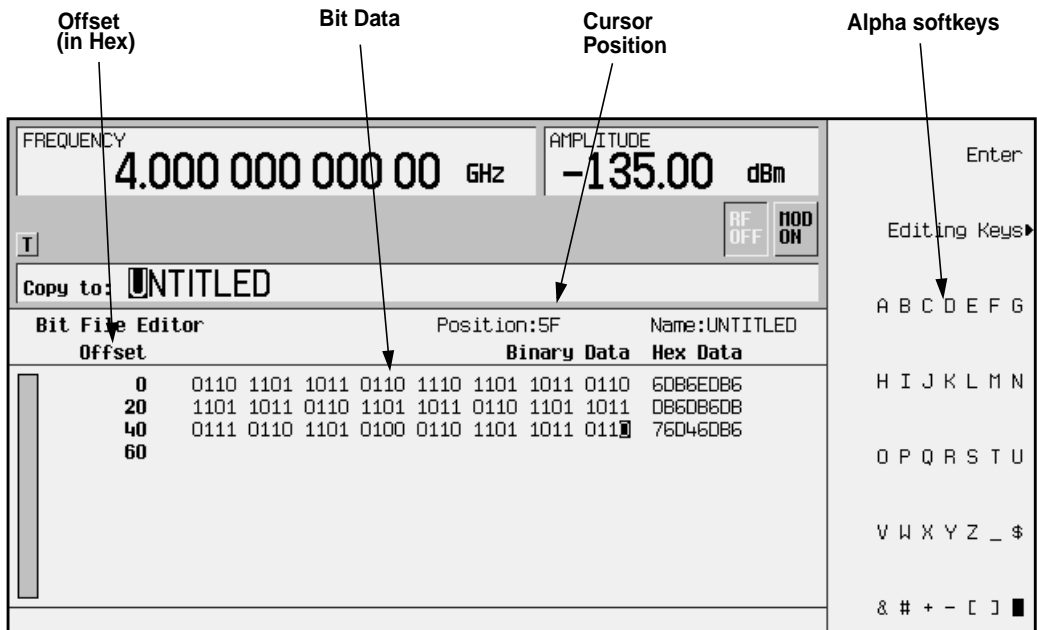

- Using the alpha softkeys and numeric keypad, enter `USER1` and press **Enter**. The user file has now been copied to the Bit memory catalog with the name `USER1`. The file name indicator reflects the change.

USER1 is a copy of UNTITLED

FREQUENCY		4.000 000 000 00 GHz		AMPLITUDE		-135.00 dBm			
T				RF OFF		MOD ON		Rename	
								Copy File	
								Delete All Rows	
Bit File Editor		Position:5F		Name:USER1					
Offset		Binary Data		Hex Data					
0	0110 1101 1011 0110 1110 1101 1011 0110	60B6EDB6							
20	1101 1011 0110 1101 1011 0110 1101 1011	0B60B60B							
40	0111 0110 1101 0100 0110 1101 1011 0110	76D46DB6							
60									
								More (2 of 2)	

Modifying an Existing User File

Existing user files can be modified and stored using the Bit File Editor. Use the following procedure to modify the file `USER1`, created in the previous procedure, and store the modified file under a new name.

- Press the front panel **Preset** hardkey.
- Press the front panel **Mode** hardkey.
- In the softkey menu, press **Custom > Data > User File**. Highlight the file `USER1` and press **Edit File**. The Bit File Editor opens the file `USER1`, as shown in the following figure.

FREQUENCY		4.000 000 000 00 GHz		AMPLITUDE		-135.00 dBm			
T				RF OFF		MOD ON		Rename	
								Copy File	
								Delete All Rows	
Bit File Editor		Position:5F		Name:USER1					
Offset		Binary Data		Hex Data					
0	0110 1101 1011 0110 1110 1101 1011 0110	60B6EDB6							
20	1101 1011 0110 1101 1011 0110 1101 1011	0B60B60B							
40	0111 0110 1101 0100 0110 1101 1011 0110	76D46DB6							
60									
								More (2 of 2)	

6. To change the name of the file:

- Press **More (1 of 2) > Rename**. This opens the file naming menu.
- Press **Editing Keys > Clear Text** or use the **Editing Mode Insert Replace** softkey.
- Using the alpha softkeys and numeric keypad, edit the file name to read **USER2** and press **Enter**.

NOTE All entries are saved automatically as they are entered.

- The user file has now been named to the Bit memory catalog with the name **USER2**. The active entry area reflects the change.

USER1 has been named USER2

The screenshot shows the Bit File Editor interface. At the top, the frequency is set to 4.000 000 000 00 GHz and the amplitude is -135.00 dBm. The Bit File Editor window displays the following data:

Offset	Binary Data	Hex Data
0	0110 1101 1011 0110 1110 1101 1011 0110	60B6EDB6
20	1101 1011 0110 1101 1011 0110 1101 1011	0B60B60B
40	0111 0110 1101 0110 1101 1011 0110	760B60B6
60		

The interface also includes a 'Rename' button, 'Copy File', 'Delete All Rows', and 'More (2 of 2)' options.

3 Softkey Reference

This chapter lists the softkeys available with Options UN8 and 202, in alphanumeric order. The SCPI commands that duplicate these softkeys remotely are provided in Chapter 4, “[Programming Commands and Examples](#).”

Use the front panel **Mode** key to access the Option UN8 and 202 softkeys.

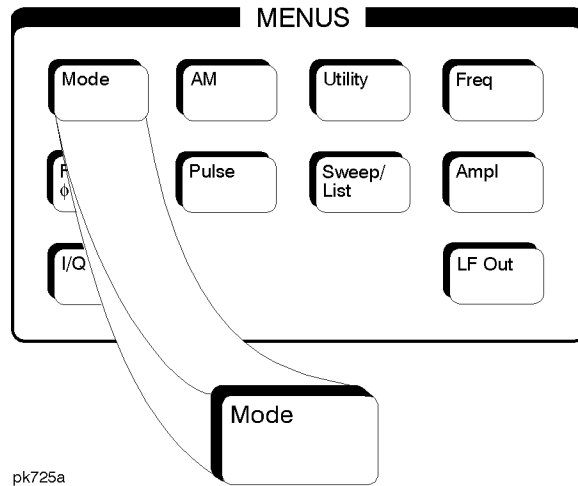

If your instrument has *only* Option UN8, after you press the **Mode** hardkey, a softkey menu displays the softkeys **Custom** and **TDMA**: press **Custom** if you want to create a custom digital modulation; press **TDMA** to display the TDMA softkeys (including DECT, GSM, NADC, PDC, PHS, EDGE, and TETRA).

If your instrument has multiple options, the softkeys in the first menu enable you to access the various options. Press **Real Time I/Q Baseband** to display the softkeys **TDMA** and **Custom**.

NOTE The key paths provided in this chapter do *not* include the **Real Time I/Q Baseband** softkey.

If you do not see a softkey in the indicated menu, it may be on the next page of that menu; to display the next page, press the **More** softkey.

Symbols

% Press this softkey to indicate acceptance of the edited I/Q Scaling value (1.0 to 9999.0%).

Softkey Location: **Mode > Custom > Configure Hardware > I/Q Scaling > %**
(this softkey appears after you edit the I/Q Scaling value)

$\pi/4$ DQPSK This softkey appears in two different situations, enabling you to either select a modulation, or load a default I/Q map into the I/Q table editor.

Selecting a Modulation

Press this softkey to select $\pi/4$ DQPSK ($\pi/4$ Differential Quadrature Phase Shift Keying) for modulating a continuous stream of the selected data pattern. $\pi/4$ DQPSK modulation transmits data at the rate of 2 bits per symbol. Notice that the modulation selection is shown in the text area of the display in the **Mod Type** field and also under the **Select** and **PSK** softkeys in the Modulation Type menus.

Softkey Locations

Custom: **Mode > Custom > Modulation Type > Select > PSK > $\pi/4$ DQPSK**

Other Formats: **Mode > TDMA > *desired format* > Modify Standard > Modulation Type > Select > PSK > $\pi/4$ DQPSK**

Loading an I/Q Map

Press this softkey to load a $\pi/4$ DQPSK ($\pi/4$ Differential Quadrature Phase Shift Keying) I/Q map into the I/Q table editor. For details on editing I/Q maps, see “[Mapping Symbol Positions with the I/Q Table Editor](#)” on page 2 -15.

Softkey Locations

Custom: **Mode > Custom > Modulation Type > Define User I/Q > Load Default I/Q Map > PSK > $\pi/4$ DQPSK**

Other Formats: **Mode > TDMA > *desired format* > Modify Standard > Modulation Type > Define User I/Q > Load Default I/Q Map > PSK > $\pi/4$ DQPSK**

Numerics

2-Lvl FSK

This softkey appears in two different situations, enabling you to either select a modulation, or load a default pattern into the FSK table editor.

Selecting a 2-Level FSK Modulation

Press this softkey to select 2-level FSK (frequency shift keying) for modulating a continuous stream of the selected data pattern. Two-level FSK modulation transmits data at the rate of 1 bit per symbol. The selected modulation appears in the `Mod Type` field in the text area of the display, and under the **Select** softkey in the Modulation Type menu.

Softkey Locations

Custom: **Mode > Custom > Modulation Type > Select > FSK > 2-Lvl FSK**

Other Formats: **Mode > TDMA > *desired format* > Modify Standard > Modulation Type > Select > FSK > 2-Lvl FSK**

Loading a 2-Level FSK Pattern into the FSK Table Editor

Press this softkey to load a 2-level FSK (frequency shift keying) modulation pattern into the FSK table editor. Two-level FSK modulation transmits data at the rate of 1 bit per symbol. For details on using the FSK table editor, see [“Building a Customized FSK Modulation with the FSK Table Editor”](#) on page 2 -22.

Softkey Locations

Custom: **Mode > Custom > Modulation Type > Define User FSK > Load Default FSK > 2-Lvl FSK**

Other Formats: **Mode > TDMA > *desired format* > Modify Standard > Modulation Type > Define User FSK > Load Default FSK > 2-Lvl FSK**

3-Bit Sync

Use this softkey to select a signal that is three times the bit clock rate for the output of the rear panel SYMBOL SYNC OUT port.

Softkey Location: **Mode > TDMA > EDGE (Rev 8.3.0Release 1999) > BNC MUX Settings > Symbol Sync Out > 3-Bit Sync**

4 1's & 4 0's

Use this softkey to select a binary data pattern that consists of four ones followed by four zeroes. This selection is available either as a data pattern (not framed) or for use with framed data transmissions.

Selecting a 4 1's & 4 0's Data Pattern

When you select **4 1's & 4 0's**, both the **Data** and the **Other Patterns** softkeys show this selection. In addition, P4 (where "P" refers to Pattern and "4" refers to four ones and eight zeroes) appears in the **Data** field in the top line of the text area of the display.

Softkey Locations

Custom: **Mode > Custom > Data > Other Patterns > 4 1's & 4 0's**

Other Formats: **Mode > TDMA > *desired format* > Data > Other Patterns > 4 1's & 4 0's**

Selecting 4 1's & 4 0's in a Framed Data Transmission

When you select **4 1's & 4 0's** in a framed data transmission, both the **B field** and the **Other Patterns** softkeys show this selection. Also, the **B field** (located near the bottom of the text area of the display) indicates P4. A single output of a framed P4 data pattern consists of enough repetitions of four ones followed by four zeroes to fill the data field in the timeslot.

Softkey Locations

DECT: **Mode > TDMA > DECT > Data Format Pattern Framed > Configure Timeslots > Configure Traffic Bearer > B field > Other Patterns > 4 1's & 4 0's**

4 1's & 4 0's is also located in the **Other Patterns** menus found in the portable part **Configure Traffic Bearer** menu and in the portable part and radio fixed part **Configure Low Capacity** menus.

EDGE and GSM: **Mode > TDMA > *desired format* > Data Format Pattern Framed > Configure Timeslots > Configure Normal > E > Other Patterns > 4 1's & 4 0's**

4 1's & 4 0's is also located in the **Other Patterns** menus found in the **Configure Sync**, **Configure Access**, and **Configure Custom** menus.

NADC: **Mode > TDMA > NADC > Data Format Pattern Framed > Configure Timeslots > Configure Up TCH > Data > Other Patterns > 4 1's & 4 0's**

4 1's & 4 0's is also located in the **Other Patterns** menus found in the **Down TCH**, **Up Custom**, and **Down Custom** menus.

PDC: **Mode > TDMA > PDC > Data Format Pattern Framed > Configure Timeslots > Configure Up TCH > TCH > Other Patterns > 4 1's & 4 0's**

4 1's & 4 0's is also located in the **Other Patterns** menus found in the

Down TCH, Up Custom, and Down Custom menus.

PHS: **Mode > TDMA > PHS > Data Format Pattern Framed > Configure Timeslots > Configure TCH > TCH > Other Patterns > 4 1's & 4 0's**

4 1's & 4 0's is also located in the Other Patterns menu found in the uplink and downlink Configure Custom menus, and uplink Configure TCH menu.

TETRA: **Mode > TDMA > TETRA > Data Format Pattern Framed > Configure Timeslots > Configure Up Normal > Data > Other Patterns > 4 1's & 4 0's**

4 1's & 4 0's is also located in the Other Patterns menu found in every other TETRA Configure Timeslots menu.

4-Lvl FSK

This softkey appears in two different situations, enabling you to either select a modulation, or load a default pattern into the FSK table editor.

Selecting a 4-Level FSK Modulation

Press this softkey to select 4-level FSK (frequency shift keying) for modulating a continuous stream of the selected data pattern. Four-level FSK modulation transmits data at the rate of 2 bits per symbol. The selected modulation appears in the **Mod Type** field in the text area of the display, and under the **Select** softkey in the Modulation Type menu.

Softkey Locations

Custom: **Mode > Custom > Modulation Type > Select > FSK > 4-Lvl FSK**

Other Formats: **Mode > TDMA > *desired format* > Modify Standard > Modulation Type > Select > FSK > 4-Lvl FSK**

Loading a 4-Level FSK Pattern into the FSK Table Editor

Press this softkey to load a 4-level FSK (frequency shift keying) modulation pattern into the FSK table editor. Four-level FSK modulation transmits data at the rate of 2 bits per symbol. For details on using the FSK table editor, see [“Building a Customized FSK Modulation with the FSK Table Editor”](#) on page 2-22.

Softkey Locations

Custom: **Mode > Custom > Modulation Type > Define User FSK > Load Default FSK > 4-Lvl FSK**

Other Formats: **Mode > TDMA > *desired format* > Modify Standard > Modulation Type > Define User FSK > Load Default FSK > 4-Lvl FSK**

4QAM

This softkey appears in two different situations, enabling you to either select a modulation, or load a default I/Q map into the I/Q table editor.

Selecting a 4QAM Modulation

Press this softkey to select 4QAM (4-state quadrature amplitude modulation) to modulate a continuous stream of the selected data pattern. 4QAM modulation transmits data at the rate of 2 bits per symbol. The selected modulation appears in the `Mod Type` field in the text area of the display, and under the **Select** and **QAM** softkeys in the Modulation Type menu.

Softkey Locations

Custom: **Mode** > **Custom** > **Modulation Type** > **Select** > **QAM** > **4QAM**

Other Formats: **Mode** > **TDMA** > *desired format* > **Modify Standard** > **Modulation Type** > **Select** > **QAM** > **4QAM**

Loading a 4QAM I/Q Map into the I/Q Table Editor

Press this softkey to load a 4QAM (4-state quadrature amplitude modulation) I/Q map into the I/Q table editor. For details on editing I/Q maps, see “[Mapping Symbol Positions with the I/Q Table Editor](#)” on page 2 -15.

Softkey Locations

Custom: **Mode** > **Custom** > **Modulation Type** > **Define User I/Q** > **Load Default I/Q Map** > **QAM** > **4QAM**

Other Formats: **Mode** > **TDMA** > *desired format* > **Modify Standard** > **Modulation Type** > **Define User I/Q** > **Load Default I/Q Map** > **QAM** > **4QAM**

8 1's & 8 0's

Use this softkey to select a binary data pattern that consists of eight ones followed by eight zeroes. This selection is available either as a data pattern (not framed) or for use with framed data transmissions.

Selecting an 8 1's & 8 0's Data Pattern

When you select **8 1's & 8 0's**, both the **Data** and the **Other Patterns** softkeys show this selection. In addition, P8 (where “P” refers to Pattern and “8” refers to eight ones and eight zeroes) is displayed in the `Data` field in the top line of the text area of the display.

Softkey Locations

Custom: **Mode** > **Custom** > **Data** > **Other Patterns** > **8 1's & 8 0's**

Other Formats: **Mode** > **TDMA** > *desired format* > **Data** > **Other Patterns** > **8 1's & 8 0's**

Selecting 8 1's & 8 0's in a Framed Data Transmission

When you select 8 1's & 8 0's in a framed data transmission, both the **B** field and the **Other Patterns** softkeys show this selection. Also, the **B** field (located near the bottom of the text area of the display) indicates P8. A single output of a framed P8 data pattern consists of enough repetitions of eight ones followed by eight zeroes to fill the data field in the timeslot.

Softkey Locations

DECT: **Mode > TDMA > DECT > Data Format Pattern Framed > Configure Timeslots > Configure Traffic Bearer > B field > Other Patterns > 8 1's & 8 0's**

8 1's & 8 0's is also located in the Other Patterns menus found in the portable part Configure Traffic Bearer menu and in the portable part and radio fixed part Configure Low Capacity menus.

EDGE and GSM: **Mode > TDMA > *desired format* > Data Format Pattern Framed > Configure Timeslots > Configure Normal > E > Other Patterns > 8 1's & 8 0's**

8 1's & 8 0's is also located in the Other Patterns menus found in the Configure Sync, Configure Access, and Configure Custom menus.

NADC: **Mode > TDMA > NADC > Data Format Pattern Framed > Configure Timeslots > Configure Up TCH > Data > Other Patterns > 8 1's & 8 0's**

8 1's & 8 0's is also located in the Other Patterns menus found in the Down TCH, Up Custom, and Down Custom menus.

PDC: **Mode > TDMA > NADC or PDC > Data Format Pattern Framed > Configure Timeslots > Configure Up TCH > TCH > Other Patterns > 8 1's & 8 0's**

8 1's & 8 0's is also located in the Other Patterns menus found in the Down TCH, Up Custom, and Down Custom menus.

PHS: **Mode > TDMA > PHS > Data Format Pattern Framed > Configure Timeslots > Configure TCH > TCH > Other Patterns > 8 1's & 8 0's**

8 1's & 8 0's is also located in the Other Patterns menus found in the uplink and downlink Configure Custom menus, and uplink Configure TCH menu.

TETRA: **Mode > TDMA > TETRA > Data Format Pattern Framed > Configure Timeslots > Configure Up Normal > Data > Other Patterns > 8 1's & 8 0's**

8 1's & 8 0's is also located in the Other Patterns menus found in every other TETRA Configure Timeslots menu.

8-Lvl FSK

This softkey appears in two different situations, enabling you to either select a modulation, or load a default pattern into the FSK table editor.

Selecting an 8-level FSK Modulation

Press this softkey to select 8-level FSK (frequency shift keying) for modulating a continuous stream of the selected data pattern.

Eight-level FSK modulation transmits data at the rate of 3 bits per symbol. The selected modulation appears in the `Mod Type` field in the text area of the display, and under the **Select** softkey in the Modulation Type menu.

Softkey Locations

Custom: **Mode** > **Custom** > **Modulation Type** > **Select** > **FSK** > **8-Lvl FSK**

Other Formats: **Mode** > **TDMA** > *desired format* > **Modify Standard** > **Modulation Type** > **Select** > **FSK** > **8-Lvl FSK**

Loading an 8-Level FSK Pattern into the FSK Table Editor

Press this softkey to load a 8-level FSK (frequency shift keying) modulation pattern into the FSK table editor. Eight-level FSK modulation transmits data at the rate of 3 bits per symbol. For details on using the FSK table editor, see “[Building a Customized FSK Modulation with the FSK Table Editor](#)” on page 2 -22.

Softkey Locations

Custom: **Mode** > **Custom** > **Modulation Type** > **Define User FSK** > **Load Default FSK** > **8-Lvl FSK**

Other Formats: **Mode** > **TDMA** > *desired format* > **Modify Standard** > **Modulation Type** > **Define User FSK** > **Load Default FSK** > **8-Lvl FSK**

8PSK

This softkey appears in two different situations, enabling you to either select a modulation, or load a default I/Q map into the I/Q table editor.

Selecting an 8PSK Modulation

Press this softkey to select 8PSK (8-state phase shift keying) to modulate a continuous stream of the selected data pattern. 8PSK modulation transmits data at the rate of bits per symbol. The selected modulation appears in the `Mod Type` field in the text area of the display, and under the **Select** and **PSK** softkeys in the Modulation Type menus.

Softkey Locations

Custom: **Mode** > **Custom** > **Modulation Type** > **Select** > **PSK** > **8PSK**

Other Formats: **Mode** > **TDMA** > *desired format* > **Modify Standard** > **Modulation Type** > **Select** > **PSK** > **8PSK**

Loading an 8PSK I/Q Map into the I/Q Table Editor

Press this softkey to load a 8PSK (8-state phase shift keying) I/Q map into the I/Q table editor. For details on editing I/Q maps, see [“Mapping Symbol Positions with the I/Q Table Editor”](#) on page 2 -15.

Softkey Locations

Custom: **Mode** > **Custom** > **Modulation Type** > **Define User I/Q** > **Load Default I/Q Map** > **PSK** > **8PSK**

Other Formats: **Mode** > **TDMA** > *desired format* > **Modify Standard** > **Modulation Type** > **Define User I/Q** > **Load Default I/Q Map** > **PSK** > **8PSK**

16 1's & 16 0's

Use this softkey to select a binary data pattern that consists of 16 ones followed by 16 zeroes. This selection is available either as a data pattern (not framed) or for use with framed data transmissions.

Selecting a 16 1's & 16 0's Data Pattern

When you select **16 1's & 16 0's**, both the **Data** and the **Other Patterns** softkeys show this selection. In addition, `P16` (where “P” refers to Pattern and “16” refers to 16 ones and 16 zeroes) is displayed in the `Data` field in the top line of the text area of the display.

Softkey Locations

Custom: **Mode** > **Custom** > **Data** > **Other Patterns** > **16 1's & 16 0's**

Other Formats: **Mode** > **TDMA** > *desired format* > **Data** > **Other Patterns** > **16 1's & 16 0's**

Selecting 16 1's & 16 0's in a Framed Data Transmission

When you select **16 1's & 16 0's** in a framed data transmission, both the **B** field and the **Other Patterns** softkeys show this selection. Also, the **B** field (located near the bottom of the text area of the display) indicates P16. A single output of a framed P16 data pattern consists of enough repetitions of 16 ones followed by 16 zeroes to fill the data field in the timeslot.

Softkey Locations

DECT: Mode > TDMA > DECT > Data Format Pattern Framed > Configure Timeslots > Configure Traffic Bearer > B field > Other Patterns > 16 1's & 16 0's

16 1's & 16 0's is also located in the **Other Patterns** menus found in the portable part **Configure Traffic Bearer** menu and in the portable part and radio fixed part **Configure Low Capacity** menus.

EDGE and GSM: Mode > TDMA > *desired format* > Data Format Pattern Framed > Configure Timeslots > Configure Normal > E > Other Patterns > 16 1's & 16 0's

16 1's & 16 0's is also located in the **Other Patterns** menus found in the **Configure Sync**, **Configure Access**, and **Configure Custom** menus.

NADC: Mode > TDMA > NADC > Data Format Pattern Framed > Configure Timeslots > Configure Up TCH > Data > Other Patterns > 16 1's & 16 0's

16 1's & 16 0's is also located in the **Other Patterns** menus found in the **Down TCH**, **Up Custom**, and **Down Custom** menus.

PDC: Mode > TDMA > PDC > Data Format Pattern Framed > Configure Timeslots > Configure Up TCH > TCH > Other Patterns > 16 1's & 16 0's

16 1's & 16 0's is also located in the **Other Patterns** menus found in the **Down TCH**, **Up Custom**, and **Down Custom** menus.

PHS: Mode > TDMA > PHS > Data Format Pattern Framed > Configure Timeslots > Configure TCH > Data > Other Patterns > 16 1's & 16 0's

16 1's & 16 0's is also located in the **Other Patterns** menus found in the uplink and downlink **Configure Custom** menus, and uplink **Configure TCH** menu.

TETRA: Mode > TDMA > TETRA > Data Format Pattern Framed > Configure Timeslots > Configure Up Normal > Data > Other Patterns > 16 1's & 16 0's

16 1's & 16 0's is also located in the **Other Patterns** menus found in every other **TETRA Configure Timeslots** menu.

16-Lvl FSK This softkey appears in two different situations, enabling you to either select a modulation, or load a default pattern into the FSK table editor.

Selecting a 16-level FSK Modulation

Press this softkey to select 16-level FSK (frequency shift keying) for modulating a continuous stream of the selected data pattern. 16-level FSK modulation transmits data at the rate of 4 bits per symbol. The selected modulation appears in the `Mod Type` field in the text area of the display, and under the **Select** softkey in the Modulation Type menu.

Softkey Locations

Custom: **Mode > Custom > Modulation Type > Select > FSK > 16-Lvl FSK**

Other Formats: **Mode > TDMA > *desired format* > Modify Standard > Modulation Type > Select > FSK > 16-Lvl FSK**

Loading a 16-Level FSK Pattern into the FSK Table Editor

Press this softkey to load a 16-level FSK (frequency shift keying) modulation pattern into the FSK table editor. 16-level FSK modulation transmits data at the rate of 4 bits per symbol. For details on using the FSK table editor, see “[Building a Customized FSK Modulation with the FSK Table Editor](#)” on page 2 -22.

Softkey Locations

Custom: **Mode > Custom > Modulation Type > Define User FSK > Load Default FSK > 16-Lvl FSK**

Other Formats: **Mode > TDMA > *desired format* > Modify Standard > Modulation Type > Define User FSK > Load Default FSK > 16-Lvl FSK**

16PSK This softkey appears in two different situations, enabling you to either select a modulation, or load a default I/Q map into the I/Q table editor.

Selecting a 16PSK Modulation

Press this softkey to select 16PSK (16-state phase shift keying) to modulate a continuous stream of the selected data pattern. 16PSK modulation transmits data at the rate of 4 bits per symbol. The selected modulation appears in the `Mod Type` field in the text area of the display, and under the **Select** and **PSK** softkeys in the Modulation Type menus.

Softkey Locations

Custom: **Mode > Custom > Modulation Type > Select > PSK > 16PSK**

Other Formats: **Mode > TDMA > *desired format* > Modify Standard > Modulation Type > Select > PSK > 16PSK**

Loading an 16PSK I/Q Map into the I/Q Table Editor

Press this softkey to load a 16PSK (16-state phase shift keying) I/Q map into the I/Q table editor. For details on editing I/Q maps, see “[Mapping Symbol Positions with the I/Q Table Editor](#)” on page 2 -15.

Softkey Locations

Custom: **Mode** > **Custom** > **Modulation Type** > **Define User I/Q** > **Load Default I/Q Map** > **PSK** > **16PSK**

Other Formats: **Mode** > **TDMA** > *desired format* > **Modify Standard** > **Modulation Type** > **Define User I/Q** > **Load Default I/Q Map** > **PSK** > **16PSK**

16QAM

This softkey appears in two different situations, enabling you to either select a modulation, or load a default I/Q map into the I/Q table editor.

Selecting a 16QAM Modulation

Press this softkey to select 16QAM (16-state quadrature amplitude modulation) to modulate a continuous stream of the selected data pattern. 16QAM modulation transmits data at the rate of 4 bits per symbol. The selected modulation appears in the `Mod Type` field in the text area of the display, and under the **Select** and **QAM** softkeys in the Modulation Type menu.

Softkey Locations

Custom: **Mode** > **Custom** > **Modulation Type** > **Select** > **QAM** > **16QAM**

Other Formats: **Mode** > **TDMA** > *desired format* > **Modify Standard** > **Modulation Type** > **Select** > **QAM** > **16QAM**

Loading a 16QAM I/Q Map into the I/Q Table Editor

Press this softkey to load a 16QAM (16-state quadrature amplitude modulation) I/Q map into the I/Q table editor. For details on editing I/Q maps, see “[Mapping Symbol Positions with the I/Q Table Editor](#)” on page 2 -15.

Softkey Locations

Custom: **Mode** > **Custom** > **Modulation Type** > **Define User I/Q** > **Load Default I/Q Map** > **QAM** > **16QAM**

Other Formats: **Mode** > **TDMA** > *desired format* > **Modify Standard** > **Modulation Type** > **Define User I/Q** > **Load Default I/Q Map** > **QAM** > **16QAM**

32 1's & 32 0's Use this softkey to select a binary data pattern that consists of 32 ones followed by 32 zeroes. This selection is available either as a data pattern (not framed) or for use with framed data transmissions.

Selecting a 32 1's & 32 0's Data Pattern

When you select **32 1's & 32 0's**, both the **Data** and the **Other Patterns** softkeys show this selection. In addition, P32 (where "P" refers to Pattern and "32" refers to 32 ones and 32 zeroes) is displayed in the Data field in the top line of the text area of the display.

Softkey Locations

Custom: **Mode > Custom > Data > Other Patterns > 32 1's & 32 0's**

Other Formats: **Mode > TDMA > *desired format* > Data > Other Patterns > 32 1's & 32 0's**

Selecting 32 1's & 32 0's in a Framed Data Transmission

When you select **32 1's & 32 0's** in a framed data transmission, both the **B** field and the **Other Patterns** softkeys show this selection. Also, the **B** field (located near the bottom of the text area of the display) indicates P32. A single output of a framed P32 data pattern consists of enough repetitions of 32 ones followed by 32 zeroes to fill the data field in the timeslot.

Softkey Locations

DECT: **Mode > TDMA > DECT > Data Format Pattern Framed > Configure Timeslots > Configure Traffic Bearer > B field > Other Patterns > 32 1's & 32 0's**

32 1's & 32 0's is also located in the Other Patterns menus found in the portable part Configure Traffic Bearer menu and in the portable part and radio fixed part Configure Low Capacity menus.

EDGE or GSM: **Mode > TDMA > *desired format* > Data Format Pattern Framed > Configure Timeslots > Configure Normal > E > Other Patterns > 32 1's & 32 0's**

32 1's & 32 0's is also located in the Other Patterns menus found in the Configure Sync, Configure Access, and Configure Custom menus.

NADC: **Mode > TDMA > NADC > Data Format Pattern Framed > Configure Timeslots > Configure Up TCH > Data > Other Patterns > 32 1's & 32 0's**

32 1's & 32 0's is also located in the Other Patterns menus found in the Down TCH, Up Custom, and Down Custom menus.

**PDC: Mode > TDMA > PDC > Data Format Pattern Framed >
Configure Timeslots > Configure Up TCH > TCH > Other Patterns >
32 1's & 32 0's**

32 1's & 32 0's is also located in the Other Patterns menus found in the Down TCH, Up Custom, and Down Custom menus.

**PHS: Mode > TDMA > PHS > Data Format Pattern Framed >
Configure Timeslots > Configure TCH > TCH > Other Patterns >
32 1's & 32 0's**

32 1's & 32 0's is also located in the Other Patterns menus found in the uplink and downlink Configure Custom menus, and uplink Configure TCH menu.

**TETRA: Mode > TDMA > TETRA > Data Format Pattern Framed >
Configure Timeslots > Configure Up Normal > Data > Other Patterns >
32 1's & 32 0's**

32 1's & 32 0's is also located in the Other Patterns menus found in every other TETRA Configure Timeslots menu.

32QAM

This softkey appears in two different situations, enabling you to either select a modulation, or load a default I/Q map into the I/Q table editor.

Selecting a 32QAM Modulation

Press this softkey to select 32QAM (32-state quadrature amplitude modulation) to modulate a continuous stream of the selected data pattern. 32QAM modulation transmits data at the rate of 5 bits per symbol. The selected modulation appears in the **Mod Type** field in the text area of the display, and under the **Select** and **QAM** softkeys in the Modulation Type menu.

Softkey Locations

Custom: **Mode > Custom > Modulation Type > Select > QAM > 32QAM**

Other Formats: **Mode > TDMA > *desired format* > Modify Standard > Modulation Type > Select > QAM > 32QAM**

Loading a 32QAM I/Q Map into the I/Q Table Editor

Press this softkey to load a 32QAM (32-state quadrature amplitude modulation) I/Q map into the I/Q table editor. For details on editing I/Q maps, see "[Mapping Symbol Positions with the I/Q Table Editor](#)" on page 2 -15.

Softkey Locations

Custom: **Mode > Custom > Modulation Type > Define User I/Q > Load Default I/Q Map > QAM > 32QAM**

Other Formats: **Mode > TDMA > *desired format* > Modify Standard > Modulation Type > Define User I/Q > Load Default I/Q Map > QAM > 32QAM**

64 1's & 64 0's Use this softkey to select a binary data pattern that consists of 64 ones followed by 64 zeroes. This selection is available either as a data pattern (not framed) or for use with framed data transmissions.

Selecting a 64 1's & 64 0's Data Pattern

When you select **64 1's & 64 0's**, both the **Data** and the **Other Patterns** softkeys show this selection. In addition, P64 (where "P" refers to Pattern and "64" refers to 64 ones and 64 zeroes) is displayed in the **Data** field in the top line of the text area of the display.

Softkey Locations

Custom: **Mode > Custom > Data > Other Patterns > 64 1's & 64 0's**

Other Formats: **Mode > TDMA > *desired format* > Data > Other Patterns > 64 1's & 64 0's**

Selecting 64 1's & 64 0's in a Framed Data Transmission

When you select **64 1's & 64 0's** in a framed data transmission, both the **B** field and the **Other Patterns** softkeys show this selection. Also, the **B** field (located near the bottom of the text area of the display) indicates P64. A single output of a framed P64 data pattern consists of enough repetitions of 64 ones followed by 64 zeroes to fill the data field in the timeslot.

Softkey Locations

DECT: **Mode > TDMA > DECT > Data Format Pattern Framed > Configure Timeslots > Configure Traffic Bearer > B field > Other Patterns > 64 1's & 64 0's**

64 1's & 64 0's is also located in the **Other Patterns** menus found in the portable part **Configure Traffic Bearer** menu and in the portable part and radio fixed part **Configure Low Capacity** menus.

EDGE and GSM: **Mode > TDMA > *desired format* > Data Format Pattern Framed > Configure Timeslots > Configure Normal > E > Other Patterns > 64 1's & 64 0's**

64 1's & 64 0's is also located in the **Other Patterns** menus found in the **Configure Sync**, **Configure Access**, and **Configure Custom** menus.

NADC: Mode > TDMA > NADC > Data Format Pattern Framed > Configure Timeslots > Configure Up TCH > Data > Other Patterns > 64 1's & 64 0's

64 1's & 64 0's is also located in the Other Patterns menus found in the Down TCH, Up Custom, and Down Custom menus.

PDC: Mode > TDMA > PDC > Data Format Pattern Framed > Configure Timeslots > Configure Up TCH > TCH > Other Patterns > 64 1's & 64 0's

64 1's & 64 0's is also located in the Other Patterns menus found in the Down TCH, Up Custom, and Down Custom menus.

PHS: Mode > TDMA > PHS > Data Format Pattern Framed > Configure Timeslots > Configure TCH > TCH > Other Patterns > 64 1's & 64 0's

64 1's & 64 0's is also located in the Other Patterns menus found in the uplink and downlink Configure Custom menus, and uplink Configure TCH menu.

TETRA: Mode > TDMA > TETRA > Data Format Pattern Framed > Configure Timeslots > Configure Up Normal > Data > Other Patterns > 64 1's & 64 0's

64 1's & 64 0's is also located in the Other Patterns menus found in every other TETRA Configure Timeslots menu.

64QAM

This softkey appears in two different situations, enabling you to either select a modulation, or load a default I/Q map into the I/Q table editor.

Selecting a 64QAM Modulation

Press this softkey to select 64QAM (64-state quadrature amplitude modulation) to modulate a continuous stream of the selected data pattern. 64QAM modulation transmits data at the rate of 6 bits per symbol. The selected modulation appears in the *Mod Type* field in the text area of the display, and under the **Select** and **QAM** softkeys in the Modulation Type menu.

Softkey Locations

Custom: **Mode > Custom > Modulation Type > Select > QAM > 64QAM**

Other Formats: **Mode > TDMA > *desired format* > Modify Standard > Modulation Type > Select > QAM > 64QAM**

Loading a 64QAM I/Q Map into the I/Q Table Editor

Press this softkey to load a 64QAM (64-state quadrature amplitude modulation) I/Q map into the I/Q table editor. For details on editing I/Q maps, see "[Mapping Symbol Positions with the I/Q Table Editor](#)" on page 2 -15.

Softkey Locations

Custom: **Mode** > **Custom** > **Modulation Type** > **Define User I/Q** >
Load Default I/Q Map > **QAM** > **64QAM**

Other Formats: **Mode** > **TDMA** > *desired format* > **Modify Standard** >
Modulation Type > **Define User I/Q** > **Load Default I/Q Map** > **QAM** > **64QAM**

256QAM

This softkey appears in two different situations, enabling you to either select a modulation, or load a default I/Q map into the I/Q table editor.

Selecting a 256QAM Modulation

Press this softkey to select 256QAM (256-state quadrature amplitude modulation) to modulate a continuous stream of the selected data pattern. 256QAM modulation transmits data at the rate of 8 bits per symbol. The selected modulation appears in the **Mod Type** field in the text area of the display, and under the **Select** and **QAM** softkeys in the **Modulation Type** menu.

Softkey Locations

Custom: **Mode** > **Custom** > **Modulation Type** > **Select** > **QAM** > **256QAM**

Other Formats: **Mode** > **TDMA** > *desired format* > **Modify Standard** >
Modulation Type > **Select** > **QAM** > **256QAM**

Loading a 256QAM I/Q Map into the I/Q Table Editor

Press this softkey to load a 256QAM (256-state quadrature amplitude modulation) I/Q map into the I/Q table editor. For details on editing I/Q maps, see [“Mapping Symbol Positions with the I/Q Table Editor”](#) on page 2 -15.

Softkey Locations

Custom: **Mode** > **Custom** > **Modulation Type** > **Define User I/Q** >
Load Default I/Q Map > **QAM** > **256QAM**

Other Formats: **Mode** > **TDMA** > *desired format* > **Modify Standard** >
Modulation Type > **Define User I/Q** > **Load Default I/Q Map** > **QAM** >
256QAM

800 MHz Base

Pressing this softkey selects 800 MHz Base as the frequency band for PDC. The 800 MHz Base contains channels 1 through 320.

Softkey Location: **Mode** > **TDMA** > **PDC** > **Freq Channels** > **Channel Band** >
800 MHz Base

800 MHz Mobile

Pressing this softkey selects 800 MHz Mobile as the frequency band for PDC. The 800 MHz Mobile contains channels 1 through 320.

Softkey Location: **Mode > TDMA > PDC > Freq Channels > Channel Band > 800 MHz Mobile**

1500 MHz Base

Pressing this softkey selects 1500 MHz Base as the frequency band for PDC. The 1500 MHz Base contains channels 1 through 480.

Softkey Location: **Mode > TDMA > PDC > Freq Channels > Channel Band > 1500 MHz Base**

1500 MHz Mobile

Pressing this softkey selects 1500 MHz Mobile as the frequency band for PDC. The 1500 MHz Mobile contains channels 1 through 480.

Softkey Location: **Mode > TDMA > PDC > Freq Channels > Channel Band > 1500 MHz Mobile**

A

A field

Press this softkey to make the hexadecimal value of the 64-bit A field the active function; the current value appears in the A field near the bottom of the text area of the display. The preset value (when normal preset is selected) reflects the DECT format, but you can enter a new hexadecimal value.

Both the A field and the B field are sub-fields of the DECT D field. The A field comprises 48 bits of signalling data and 16 bits of error correction.

Default Value: 0000FFFF0000FFFF

Softkey Location: **Mode > TDMA > DECT > Data Format Pattern Framed > Configure Timeslots > Configure Traffic Bearer > A field**

A field is also located in the portable part Configure Traffic Bearer menu and the radio fixed part and portable part Low Capacity menus.

Access

Press this softkey to select access as the timeslot type for the active timeslot. Access is a short uplink burst for the mobile to access service from a base station.

When you select Access for a timeslot, the visual representation of the timeslot pattern on the display is immediately updated to show you selection.

Softkey Location: **Mode > TDMA > GSM > Data Format Pattern Framed > Configure Timeslots > Timeslot Type > Access**

All Timeslots

Press this softkey to output a 1-bit pulse at the EVENT 1 rear panel connector that is synchronized to the first bit of each timeslot. If you have entered a value for **Sync Out Offset**, the synchronizing pulse is offset by the number of bits specified.

Softkey Locations

Custom: **Mode > Custom > Sync Out > All Timeslots**

Other Formats: **Mode > TDMA > *desired format* > Data Format Pattern Framed > Sync Out > All Timeslots**

APCO 25 C4FM

This key selects an Association of Public-safety Communications Officials (APCO) 25 specified C4FM filter in the **Select** (filter) menu. This is a Nyquist filter with an alpha of 0.2 that is combined with a shaping filter.

Softkey Locations

Custom: **Mode > Custom > Predefined Mode > APCO 25 w/C4FM**

Or: **Mode > Custom > Filter > Select > APCO 25 C4FM**

Other Formats: **Mode > TDMA > *desired format* > Modify Standards > Filter > Select > APCO 25 C4FM**

APCO 25 w/C4FM

Press this softkey to set up a predefined APCO 25-compliant digital modulation format with C4FM (compatible 4-level frequency modulation) as the modulation type to modulate a continuous stream of the selected data pattern with a maximum deviation of 1.8 kHz. C4FM is an APCO 25-compliant, 4-level FSK (frequency shift keying) modulation that transmits data at the rate of 2 bits per symbol (4.8 ksps).

NOTE

APCO 25 (Association of Public-Safety Communications Officials - International, Inc., Project 25) is a standard-setting initiative for public-safety communications.

Softkey Location: **Mode > Custom > Predefined Mode > APCO 25 w/C4FM**

APCO 25 w/CQPSK

Press this softkey to set up a predefined APCO 25-compliant digital modulation format with CQPSK (compatible quadrature phase shift keying) as the modulation type to modulate a continuous stream of the selected data pattern. CQPSK uses $\pi/4$ DQPSK ($\pi/4$ differential quadrature phase shift keying) modulation, which transmits data at the rate of 2 bits per symbol (4.8 ksps).

Softkey Location: **Mode > Custom > Predefined Mode > APCO 25 w/CQPSK**

B

B Press this softkey to make the hexadecimal 30-bit broadcast bits (B) the active function. The current value for broadcast bits is displayed in the B field near the bottom of the text area of the display.

Default Value: 00000000

Softkey Location: **Mode > TDMA > TETRA > Data Format Pattern Framed > Configure Timeslots > Timeslot Type > Dn Sync Cont > Configure Dn Sync Cont > B**

Or: **Mode > TDMA > TETRA > Data Format Pattern Framed > Configure Timeslots > Timeslot Type > Dn Sync Disc > Configure Dn Sync Disc > B**

B field

Pressing this softkey displays a menu of softkeys where you can choose either internal data generation (PN9, PN15, fixed, 4-bit repeating sequences, set patterns of ones and zeroes), or your own data (download a binary file or input data using the DATA INPUT connector) for configuring the timeslot data bit fields (B field). (The A field and the B field are sub-fields of the DECT D field.)

Default Value: PN23

Softkey Location: **Mode > TDMA > DECT > Data Format Pattern Framed > Configure Timeslots > Configure Traffic Bearer > B field**

B field is also located in the portable part Configure Traffic Bearer menu and the radio fixed part and portable part Low Capacity menus.

B1

Press this softkey to make the hexadecimal 14-bit broadcast bits (B1) the active function. The current value for broadcast bits is displayed in the B1 field near the bottom of the text area of the display.

Default Value: 0000

Softkey Location: **Mode > TDMA > TETRA > Data Format Pattern Framed > Configure Timeslots > Timeslot Type > Dn Normal Cont > Configure Dn Normal Cont > B1**

Or: **Mode > TDMA > TETRA > Data Format Pattern Framed > Configure Timeslots > Timeslot Type > Dn Normal Disc > Configure Dn Normal Disc > B1**

B2 Press this softkey to make the hexadecimal 16-bit broadcast bits (B2) the active function. The current value for broadcast bits is displayed in the B2 field near the bottom of the text area of the display.

Default Value: 0000

Softkey Location: **Mode > TDMA > TETRA > Data Format Pattern Framed > Configure Timeslots > Timeslot Type > Dn Normal Cont > Configure Dn Normal Cont > B2**

Or: **Mode > TDMA > TETRA > Data Format Pattern Framed > Configure Timeslots > Timeslot Type > Dn Normal Disc > Configure Dn Normal Disc > B2**

Base Pressing this softkey selects Standard Base as the channel band for NADC. Base contains channels 1 through 799 and 990 through 1023.

Softkey Location: **Mode > TDMA > NADC > Freq Channels > Channel Band > Base**

BBG Data Clock Ext Int

Press this softkey to select the internal data clock for the baseband generator or to select an externally-supplied data clock. A data clock or symbol sync input must be supplied when external mode is selected. For more information on input and output signals, refer to [Chapter 6, "Theory of Operation."](#)

Default Value: Int

Softkey Locations

Custom: **Mode > Custom > Configure Hardware > BBG Data Clock Ext Int**

Other Formats: **Mode > TDMA > *desired format* > Configure Hardware > BBG Data Clock Ext Int**

Begin Frame Press this softkey to output a 1-bit pulse to the EVENT 1 rear panel connector that is synchronized to the first bit of the first frame. If you have entered a value for **Sync Out Offset**, the synchronizing pulse is offset by the number of bits specified. The number of trigger pulses generated depends on the framed data pattern selected:

- A PN9 or PN15 data pattern generates a single frame. The frame's data fields are filled sequentially with the PRBS data. The synchronizing pulse occurs at the beginning of the frame each time it is transmitted.
- Any combination of a PN9 data pattern and *external* data generates 511 frames. The synchronizing pulse occurs at the beginning of the first of the 511 frames each time that frame is transmitted.

- Any combination of a PN15 data pattern and *either* external data *or* user's files generates a discontinuous PN15 pattern, which consists of as many complete frames of PN15 data as can be generated. The remaining bits that do not completely fill a frame are truncated. The synchronizing pulse occurs at the beginning of the first frame each time that frame is transmitted.

Softkey Location: **Mode > TDMA > *desired format* > Data Format Pattern Framed > Sync Out > Begin Frame**

Begin Pattern

Press this softkey to output a 1-bit pulse to the EVENT 1 rear panel connector that is synchronized to the first bit of an *unframed* data pattern, and for each repetition of the pattern. If you enter a value for **Sync Out Offset**, the synchronizing pulse is offset by the number of bits specified.

Softkey Locations

Custom: **Mode > Custom > Sync Out > Begin Pattern**

Other Formats: **Mode > TDMA > *desired format* > Sync Out > Begin Pattern**

Begin Timeslot

Press this softkey to make the timeslot number the active function. You can then specify which timeslot you want to trigger the rear-panel external trigger EVENT 1 output (a 1-bit signal synchronized to the first bit of the selected timeslot).

If you enter a value for **Sync Out Offset**, the synchronizing pulse is offset by the number of bits specified.

In the NADC Format

In NADC full-rate, you can select timeslots 1, 2, or 3;
in NADC half-rate, you can select timeslots 1 through 6.

In the PDC Format

In PDC full-rate, you can select timeslots 0, 1, or 2;
in PDC half-rate, you can select timeslots 0 through 5.

Softkey Locations

Custom: **Mode > Custom > Sync Out > Begin Timeslot**

Other Formats: **Mode > TDMA > *desired format* > Data Format Pattern Framed > Sync Out > Begin Timeslot**

Beta

This softkey is activated automatically when the Kaiser windowing function is selected. The default Beta factor provides a good compromise for optimizing out of band performance (ACP) without seriously compromising passband performance (EVM). Changing the Beta factor adjusts the trade-off between ACP and EVM. Decreasing the value improves EVM. Increasing the value improves ACP.

Range: 1.000 through 10.000

Default Value: 4.000

Softkey Location: **Mode** > **TDMA** > *desired format* > **Modify Standard** > **Filter** > **Define User I/Q** > **Load Default FIR** > **Root Nyquist** (or any other filter) > **Window** > **Kaiser** > **Beta**

Bit Clock

Use this softkey to select a bit clock signal for the output at the rear panel DATA CLK OUT port. This clock rate is normally set to 812.5 kHz.

Softkey Location: **Mode** > **TDMA** > **EDGE (Rev 8.3.0Release 1999)** > **BNC MUX Settings** > **Data Clk Out** > **Bit Clock**

Bluetooth

Press this softkey to set up a predefined Bluetooth digital modulation format to modulate a continuous stream of the selected data pattern with the default maximum deviation set to 157.5 kHz. Bluetooth uses 2-level FSK (frequency shift keying) modulation that transmits data at the rate of 1 bit per symbol (1 Msps).

Softkey Location: **Mode** > **Custom** > **Predefined Mode** > **Bluetooth**

BNC MUX Settings

This key accesses a menu of softkeys from which you can modify the output of the rear panel BNC/SMB connectors.

Softkey Location: **Mode** > **TDMA** > **EDGE (Rev 8.3.0 Release 1999)** > **BNC MUX Settings**

BPSK

This softkey appears in two different situations, enabling you to either select a modulation, or load a default I/Q map into the I/Q table editor.

Selecting a BPSK Modulation

Press this softkey to select BPSK (binary phase shift keying) modulation for modulating a continuous stream of the selected data pattern. BPSK modulation transmits data at the rate of 1 bit per symbol. The selected modulation appears in the **Mod Type** field in the text area of the display, and under the **Select** and **PSK** softkeys in the Modulation Type menus.

Softkey Locations

Custom: **Mode > Custom > Modulation Type > Select > PSK > BPSK**

Other Formats: **Mode > TDMA > *desired format* > Modify Standard > Modulation Type > Select > PSK > BPSK**

Loading a BPSK I/Q Map into the I/Q Table Editor

Press this softkey to load a BPSK (binary phase shift keying) modulation I/Q map into the I/Q table editor. For details on editing I/Q maps, see [“Mapping Symbol Positions with the I/Q Table Editor”](#) on page 2 -15.

Softkey Locations

Custom: **Mode > Custom > Modulation Type > Define User I/Q > Load Default I/Q Map > PSK > BPSK**

Other Formats: **Mode > TDMA > *desired format* > Modify Standard > Modulation Type > Define User I/Q > Load Default I/Q Map > PSK > BPSK**

Burst Shape

Press this softkey to display the Burst Shape softkey menu where you can modify the rise and fall time and the rise and fall delay of the burst shape, and select the shape of the burst. A softkey is also provided to return the default burst shape values.

Softkey Locations

Custom: **Mode > Custom > Burst Shape**

Other Formats: **Mode > TDMA > *desired format* > Modify Standard > Burst Shape**

Burst Shape Type

Press this softkey to display the Burst Shape Type softkey menu where you can select the burst shape type. The choices are Sine or a user-defined burst shape stored in the signal generator’s catalog of burst shapes.

Default Value: Sine

Softkey Locations

Custom: **Mode > Custom > Burst Shape > Burst Shape Type**

Other Formats: **Mode > TDMA > *desired format* > Modify Standard > Burst Shape > Burst Shape Type**

Bus

Press this softkey to use the GPIB as the pattern trigger for a single output of an unframed data pattern or as the frame trigger for a single output of framed data. Once selected, you can trigger a single event at any time by sending a trigger command over GPIB (*TRG) or by asserting the GPIB GET (group execute trigger) line.

In secondary frame mode, selecting Bus allows the next frame type to be toggled by the commands *TRG or GET. This frame type is used once the current frame type has been completely transmitted.

NOTE

Pattern Repeat and Pattern Trigger functions are *not* available if you use either a PN data sequence or an external data source.

Softkey Locations

Custom: **Mode > Custom > Pattern Repeat Single > Pattern Trigger > Bus**

Other Formats: **Mode > TDMA > *desired format* > Pattern Repeat Single Cont > Pattern Trigger > Bus**

Or: **Mode > TDMA > *desired format* > Data Format Pattern Framed > Frame Repeat Single Cont > Frame Trigger > Bus**

Or: **Mode > TDMA > *desired format* > Data Format Pattern Framed > Configure Timeslots > Configure Frame > Secondary Frame Trigger > Bus**

C

C4FM

This softkey appears in two different situations, to either select a modulation or load a default pattern into the FSK table editor.

Selecting a C4FM FSK Modulation

Press this softkey to select C4FM to modulate a continuous stream of the selected data pattern. C4FM is an APCO 25-compliant, 4-level FSK (frequency shift keying) modulation that transmits data at the rate of 2 bits per symbol. The modulation selection appears in the `Mod Type` field in the text area of the display, and under the **Select** softkey in the Modulation Type menu.

NOTE

APCO 25 (Association of Public-Safety Communications Officials - International, Inc., Project 25) is a standard-setting initiative for public-safety communications.

Softkey Locations

Custom: **Mode > Custom > Modulation Type > Select > FSK > C4FM**

Other Formats: **Mode > TDMA > *desired format* > Modify Standard > Modulation Type > Select > FSK > C4FM**

Loading a C4FM FSK Pattern into the FSK Table Editor

Press this softkey to load a C4FM FSK (frequency shift keying) modulation pattern into the FSK table editor. C4FM FSK modulation transmits data at the rate of 2 bits per symbol. For details on using the FSK table editor, see “[Building a Customized FSK Modulation with the FSK Table Editor](#)” on page 2 -22.

Softkey Locations

Custom: **Mode > Custom > Modulation Type > Define User FSK > Load Default FSK > C4FM**

Other Formats: **Mode > TDMA > *desired format* > Modify Standard > Modulation Type > Define User FSK > Load Default FSK > C4FM**

CC Press this softkey make the 8-bit color code (CC) the active function. The preset hexadecimal value (when normal preset is selected) for CC reflects the PDC format; the current value for CC is displayed in the CC field near the bottom line of the text area of the display.

Default Value: 00

Softkey Location: **Mode > TDMA > PDC > Data Format Pattern Framed > Configure Timeslots > Configure Up TCH > CC**

CC is also located in the Configure Down TCH and the Configure Up VOX menus.

CDPD Press this softkey to set up a predefined CDPD (Cellular Digital Packet Data) digital modulation format to modulate a continuous stream of the selected data pattern. CDPD uses MSK (minimum shift keying) modulation that transmits data at the rate of 1 bit per symbol (19.2 ksps).

Softkey Location: **Mode > Custom > Predefined Mode > CDPD**

CDVCC Press this softkey to make the hexadecimal 12-bit coded digital verification color code (CDVCC) the active function. The current value for CDVCC appears in the CDVCC field near the bottom of the text area of the display.

Default Value: 000

Softkey Location: **Mode > TDMA > NADC > Data Format Pattern Framed > Configure Timeslots > Configure Up TCH > CDVCC**

CDVCC is also located in the Configure Down TCH menu.

CS-1 Press this softkey to select a packet data traffic channel with block type 1 that is in compliance with GSM 05.03.

Softkey Location: **Mode > TDMA > GSM > Data Format Pattern Framed > Configure Timeslots > Configure Normal > E > Multiframe Channel > CS-1**

Channel Band

Pressing this softkey displays a menu of softkeys where you can assign channel bands based on the current format. The output frequency depends on both the channel band and channel number selections.

Softkey Location: **Mode > TDMA > *desired format* > Freq Channels > Channel Band**

Channel Number

Pressing this softkey makes channel numbers (the frame carrier frequency) the active function based on frequency channels defined in the active format. The output frequency depends on both the channel band and channel number selections.

Range

DECT: 0 through 9	PDC: 1 through 320
EDGE and GSM: 1 through 124	PHS: 1 through 77
NADC: 1 through 1023	TETRA: 1 through 100

Softkey Location: **Mode > TDMA > *desired format* > Freq Channels > Channel Number**

Configure Access

Pressing this softkey displays a menu of softkeys where you can configure an access timeslot. The following figure shows an example of the display graphics for an access timeslot.

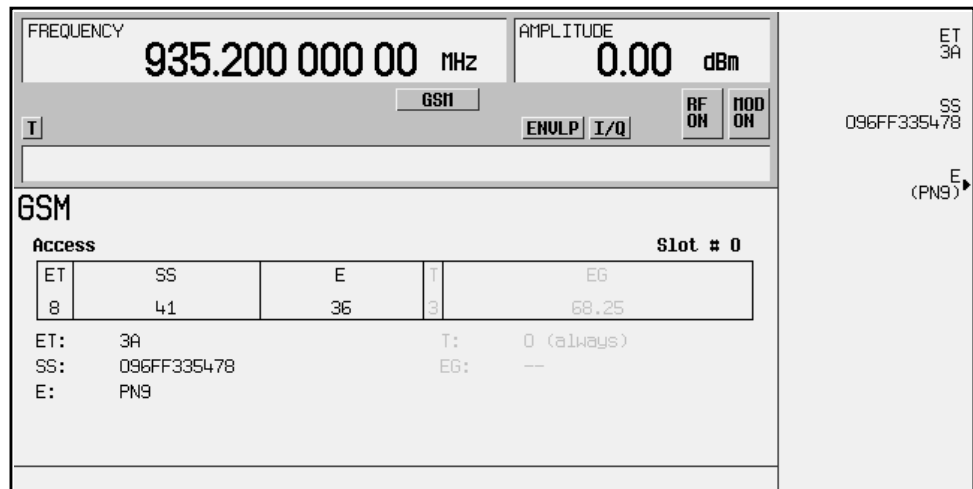

- **ET**: shows the hexadecimal value that the 8-bit extended tail is set to (3A). The **ET** softkey makes this value the active function.
- **SS**: shows the hexadecimal value that the 41-bit synchronization sequence is set to (096FF335478). The **SS** softkey makes this value the active function.

- **E**: shows the data selection (encryption bits) for this timeslot (PN9). The **E** softkey makes this value the active function. Other selections allowed include PN15, fixed 4-bit patterns, fixed patterns of ones and zeroes, user files, or external data.
- **T**: shows that the 3-bit tail field contains hexadecimal zero. The gray text in this field indicates that you cannot change the value.

EG: is the extended guard time, displayed as a 68.25-bit field. This is implemented as: 69 bit guard time field in timeslots 0 and 4, and 68 bit fields in the remaining timeslots (this implementation is documented in the GSM format *GSM REC. 05.10 Section 5.7*. “Optionally, the BS may use a timeslot length of 157 bit periods on timeslots with TN=0 and 4, and 156 bit periods on timeslots with TN=1, 2, 3, 5, 6, 7, rather than 156.25 bit periods on all timeslots”). The grey text in this field indicates that you cannot change its value.

Softkey Location: **Mode > TDMA > GSM > Data Format Pattern Framed > Configure Timeslots > Timeslot Type > Access > Configure Access**

Configure Custom

Pressing this softkey displays a menu of softkeys where you can select the data pattern for a custom timeslot in the DECT, EDGE, GSM, and PHS formats. The following figure shows an example of the display graphics for a radio fixed part custom timeslot for the DECT format. The PHS custom timeslot includes a fixed 4-bit ramp field.

FREQUENCY 1.881 792 000 00 GHz		AMPLITUDE 0.00 dBm		PH Sequence (PN9) FIX4 0000 Other Patterns▶ User File▶ Ext Dect Patterns▶
L		DECT		
ENULP I/Q		RF ON MOD ON		
DECT				
Custom		RFP		Slot # 0
G	Data		G	
1G	424		40	
G: --- Data: PN9				

- **G**: there are two guard time fields. These fields have grey text, indicating that you cannot change their content.
- **Data**: shows the data selection (PN9) for this timeslot. Other selections include PN15, fixed 4-bit patterns, fixed patterns of ones and zeroes, format-specific patterns, user files, or external data.

Softkey Location (DECT, EDGE, GSM, and PHS only): **Mode > TDMA > *desired format* > Data Format Pattern Framed > Configure Timeslots > Timeslot Type > Custom > Configure Custom**

The **Configure Custom** softkey also appears in DECT portable part, and PHS uplink Timeslot Type menus.

Configure Differential Encoding

Press this softkey to display a menu and editor (a differential state map) where you can create user-defined differential encoding for the current user-defined modulation table. Use this table to enter the symbol table offset for each binary data bit.

For a detailed explanation of differential encoding, see “[Understanding Differential Encoding](#)” on page 6-11.

For information on using the Differential State Map editor, see “[Mapping Custom Differential Encoding](#)” on page 2 -11.

Softkey Locations

Custom: **Mode > Custom > Modulation Type > Define User I/Q > Configure Differential Encoding**

Or: **Mode > Custom > Modulation Type > User FSK > Configure Differential Encoding**

Other Formats: **Mode > TDMA > *desired format* > Modify Standard > Modulation Type > Define User I/Q > Configure Differential Encoding**

Or: **Mode > TDMA > *desired format* > Modify Standard > Modulation Type > Define User FSK > Configure Differential Encoding**

Configure Dn Custom Cont

Pressing this softkey displays a menu of softkeys where you can select the data pattern for a continuous downlink custom timeslot. The following figure shows an example of the display graphics for a continuous downlink custom timeslot.

FREQUENCY 399.998 000 00 MHz		AMPLITUDE 0.00 dBm		PN Sequence (PN9) ▶	
TETRA		ENULP I/Q		RF ON MOD ON	
TETRA					
DownLink Custom Continuous				Slot # 1	
Data					
510					
Data: PN9					
Other Patterns ▶					
User File ▶					
Ext					

- Data: indicates the data selection (PN9) for this custom timeslot. Other selections include PN15, fixed 4-bit patterns, fixed patterns of ones and zeroes, user files, or external data.

Softkey Location: **Mode > TDMA > TETRA > Data Format Pattern Framed > Configure Timeslots > Timeslot Type > Dn Custom Cont > Configure Dn Custom Cont**

Configure Dn Custom Disc

Pressing this softkey displays a menu of softkeys where you can select the data pattern for a discontinuous downlink custom timeslot. The following figure shows an example of the display for a discontinuous downlink custom timeslot.

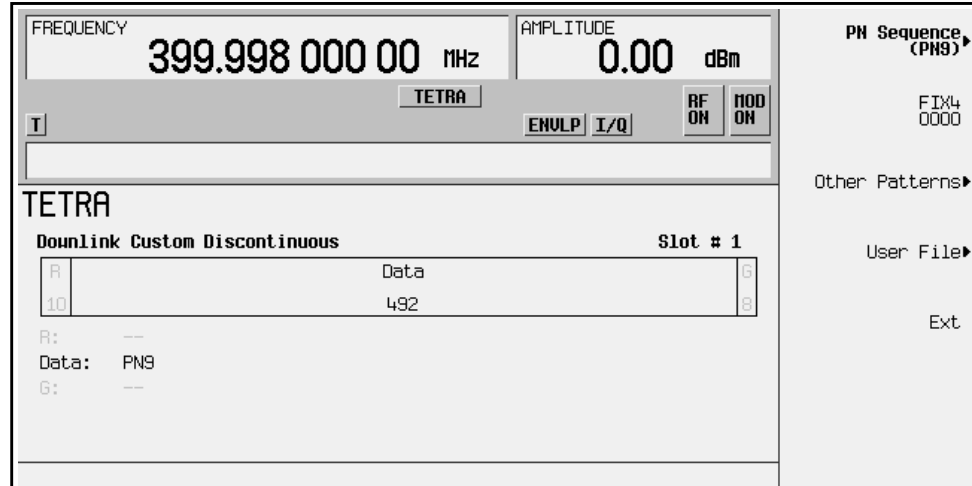

- R: ramp time is a 34-bit field. The grey text in this field indicates that you cannot change its value.
- Data: shows the data selection (PN9) for this custom timeslot. Other selections include PN15, fixed 4-bit patterns, fixed patterns of ones and zeroes, user files, or external data.
- G: guard time is a 14-bit field. The grey text in this field indicates that you cannot change its value.

Softkey Location: **Mode > TDMA > TETRA > Data Format Pattern Framed > Configure Timeslots > Timeslot Type > Dn Custom Disc > Configure Dn Custom Disc**

Configure Dn Normal Cont

Pressing this softkey displays a menu of softkeys where you can configure a timeslot as a downlink continuous normal timeslot. The display in the following figure shows each field of the timeslot as it is defined by the TETRA format.

FREQUENCY		399.998 000 00 MHz		AMPLITUDE		0.00 dBm		Data (PN9)	
L		TETRA		ENULP I/Q		RF ON		MOD ON	
TETRA									
Downlink Normal Continuous				Slot # 1					
TS1	PA	Data	B1	TS2	B2	Data	PA	TS3	
12	2	216	14	22	16	216	2	10	
TS1:		1AD (always)		TS2:		343A74			
PA:		Phase Adjustment		B2:		0000			
Data:		PN9		TS3:		2DC (always)			
B1:		0000							
B1 0000									
TS 343A74									
B2 0000									

- TS1: shows that the 12-bit training sequence field always contains hexadecimal 1AD. The grey text in this field indicates that you cannot change it.
- PA: there are two 2-bit phase adjustment fields. The grey text in these fields indicates that you cannot change their content.
- Data: shows the data selection (PN9) for both 216-bit data fields. Other selections include PN15, fixed 4-bit patterns, fixed patterns of ones and zeroes, user files, or external data.
- B1: shows the contents of the 14-bit broadcast bits field (hexadecimal 0000). The B1 softkey makes this the active function.
- TS2: shows the contents (hexadecimal 343A74) of the 22-bit training sequence field. The TS softkey makes this the active function.
- B2: shows contents (hexadecimal 0000) of the 16-bit broadcast bits field. The B2 softkey makes this the active function.
- TS3: shows the contents (hexadecimal 2DC) of the 10-bit training field. The grey text in this field indicates that you cannot change it.

Softkey Location: Mode > TDMA > TETRA > Data Format Pattern Framed > Configure Timeslots > Timeslot Type > Dn Normal Cont > Configure Dn Normal Cont

Configure Dn Normal Disc

Pressing this softkey displays a menu of softkeys where you can configure a timeslot as a downlink discontinuous normal timeslot. The following figure shows each field of the timeslot as it is defined by the TETRA format.

FREQUENCY		399.998 000 00 MHz		AMPLITUDE		0.00 dBm	
TETRA				ENULP I/Q		RF ON MOD ON	
TETRA							
Downlink Normal Discontinuous				Slot # 1			
R	TS1	PA	Data	B1	TS2	B2	Data
10	2	2	216	14	22	16	216
R: ---				TS2: 343A74			
TS1: 1 (always)				B2: 0000			
PA: Phase Adjustment				TS3: 2 (always)			
Data: PN9				G: ---			
B1: 0000							

- R: ramp time is a 10-bit field. The grey text in this field indicates that you cannot change its value.
- TS1: shows that this 2-bit training sequence field always contains hexadecimal 1. The grey text in this field indicates that you cannot change it.
- PA: there are two 2-bit phase adjustment bits fields. The grey text in these fields indicates that you cannot change the contents of either field.
- Data: shows the data selection (PN9) for both 216-bit data fields. Other selections include PN15, fixed 4-bit patterns, fixed patterns of ones and zeroes, user files, or external data.
- B1: shows the contents (hexadecimal 0000) of the 14-bit broadcast bits field. The **B1** softkey makes this the active function.
- TS2: shows the contents (hexadecimal 343A74) of the 22-bit training sequence field. The **TS** softkey makes this the active function.
- B2: shows the contents (hexadecimal 0000) of the 16-bit broadcast bits field. The **B2** softkey makes this the active function.
- TS3: shows that the 2-bit training sequence field always contains hexadecimal 2. The grey text in this field indicates that you cannot change it.

- G: guard time is an 8-bit field. The grey text in this field indicates that you cannot change its value.

Softkey Location: **Mode > TDMA > TETRA > Data Format Pattern Framed > Configure Timeslots > Timeslot Type > Dn Normal Disc > Configure Dn Normal Disc**

Configure Dn Sync Cont

Pressing this softkey opens a menu of softkeys where you can configure a timeslot as a downlink continuous synchronization timeslot. The following figure shows each field of the timeslot as it is defined by the TETRA format.

The screenshot shows a configuration screen for a TETRA timeslot. At the top, it displays 'FREQUENCY' as 399.998 000 00 MHz and 'AMPLITUDE' as 0.00 dBm. Below this are softkeys for 'TETRA', 'ENULP', 'I/Q', 'RF ON', and 'MOD ON'. On the right side, there are several fields with their corresponding values: 'FCOR' (FF00000000000000FF), 'SSB' (0000000000000000), 'STS' (30673A7067), and 'B' (00000000). A 'Data (PNS)' field is also visible with a right-pointing arrow.

The main section is titled 'TETRA' and 'Downlink Synchronization Continuous Slot # 1'. It contains a table with the following data:

TS1	PA	FCOR	SYNC	STS	B	Data	PA	TS3
12	2	80	120	38	30	216	2	10

Below the table, there are labels for each field: TS1: 1AD (always), PA: Phase Adjustment, FCOR: FF00000000000000FF, SYNC: 00000000000000000000000000000000, STS: 30673A7067, B: 00000000, Data: PNS, and TS3: 2DC (always).

- TS1: shows that this 12-bit training sequence field always contains hexadecimal 1AD. The grey text in this field indicates that you cannot change it.
- PA: there are two 2-bit phase adjustment fields. The grey text field indicates that you cannot change the contents of these fields.
- FCOR: shows the value (hexadecimal FF00000000000000FF) of the 80-bit frequency correction field. The FCOR softkey makes this the active function.
- SYNC: shows the contents (hexadecimal 00000000000000000000000000000000) of the 120-bit synchronization block bits field. The SSB softkey makes this the value.
- STS: shows the value (hexadecimal 30673A7067) of the 38-bit synchronization training sequence field. The STS softkey makes this the active function.
- B: shows the value (hexadecimal 00000000) of the 30-bit broadcast bits field. The B softkey makes this the active function.

- **Data:** shows the data selection (PN9) for the 216-bit data field. Other selections include PN15, fixed 4-bit patterns, fixed patterns of ones and zeroes, user files, or external data.
- **TS3:** shows that this 10-bit training sequence field always contains hexadecimal 2DC. The grey text in this field indicates that you cannot change it.

Softkey Location: **Mode > TDMA > TETRA > Data Format Pattern Framed > Configure Timeslots > Timeslot Type > Dn Sync Cont > Configure Dn Sync Cont**

Configure Dn Sync Disc

Pressing this softkey displays a menu of softkeys where you can configure a timeslot as a downlink discontinuous synchronization timeslot. The following figure shows each field of the timeslot as it is defined by the TETRA format.

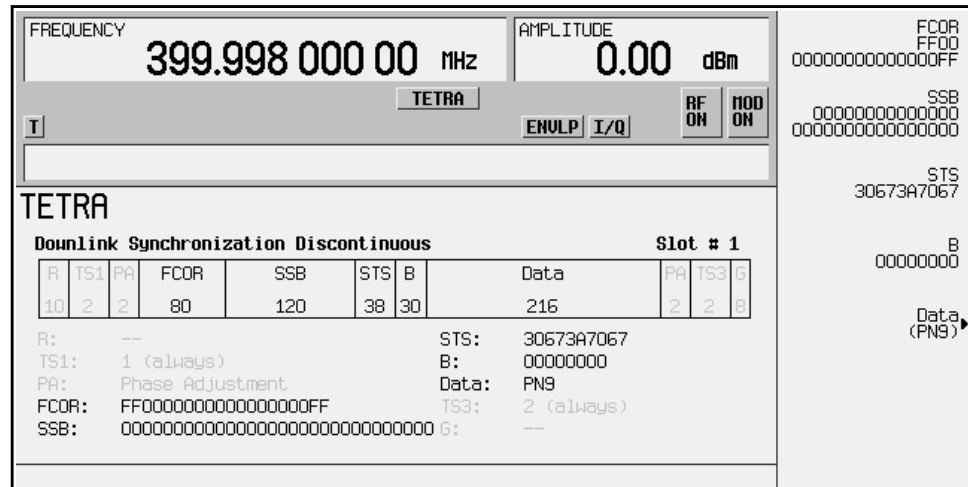

- **R:** ramp time is a 10-bit field. The grey text in this field indicates that you cannot change its value.
- **TS1:** shows that this 2-bit training sequence field always contains hexadecimal 1. The grey text in this field indicates that you cannot change it.
- **PA:** there are two 2-bit phase adjustment fields. The grey text indicates that you cannot change the contents of these fields.
- **FCOR:** shows the contents (hexadecimal FF0000000000000000FF) of the 80-bit frequency correction field. The **FCOR** softkey makes this the active function
- **SSB:** shows the contents (hexadecimal 00000000000000000000000000000000) of the 120-bit synchronization block bits field. The **SSB** softkey makes this the active function.

- **STS**: shows the contents (hexadecimal 30673A7067) of the 38-bit synchronization training sequence field. The **STS** softkey makes this the active function.
- **B**: shows the contents (hexadecimal 00000000) of the 30-bit broadcast bits field. The **B** softkey makes this the active function.
- **Data**: shows the data selection (PN9) for the 216-bit data field. Other selections include PN15, fixed 4-bit patterns, fixed patterns of ones and zeroes, user files, or external data.
- **TS3**: shows that this 2-bit training sequence field always contains hexadecimal 2. The grey text indicates that you cannot change it.
- **G**: guard time is an 8-bit field. The grey text indicates that you cannot change its value.

Softkey Location: **Mode > TDMA > TETRA > Data Format Pattern Framed > Configure Timeslots > Timeslot Type > Dn Sync Disc > Configure Dn Sync Disc**

Configure Down Custom

In either the NADC or PDC format, pressing this softkey opens a menu of softkeys where you can select the data pattern for a downlink custom timeslot. The following figure shows an example of the NADC display; the same field is available in the PDC format.

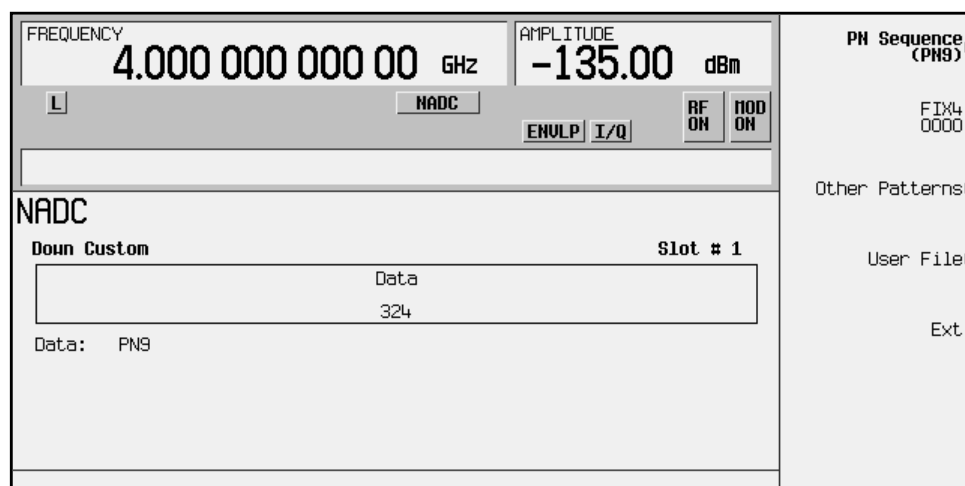

- **Data**: shows the data selection (PN9) for this custom timeslot. Other selections include PN15, fixed 4-bit patterns, fixed patterns of ones and zeroes, user files, or external data.

Softkey Location (NADC and PDC): **Mode > TDMA > desired format > Data Format Pattern Framed > Configure Timeslots > Timeslot Type > Down Custom > Configure Down Custom**

Configure Down TCH

In either the NADC or PDC format, pressing this softkey opens a menu of softkeys where you can configure a timeslot as a downlink traffic channel. The following sections describe each field of the timeslot as defined by NADC and PDC formats.

In the NADC Format

FREQUENCY 4.000 000 000 00 GHz		AMPLITUDE -135.00 dBm		Data (PN9) →	
NADC		RF ON		MOD ON	
T		EHULP I/Q		SYNC A91DE4A	
NADC					
Down TCH			Slot # 1		
SYNC	SACCH	Data	CDVCC	Data	RSVD
28	12	130	12	130	12
SYNC: A91DE4A		CDVCC: 000			
SACCH: 000		RSVD: 000 (always)			
Data: PN9					
<div style="float: right;"> SACCH 000 CDVCC 000 </div>					

- **SYNC**: shows the value of the synchronization word (hexadecimal A91DE4A). The **SYNC** softkey makes this the active function.
- **SACCH**: shows the value of the slow associated control channel (hexadecimal 000). The **SACCH** softkey makes this the active function.
- **Data**: shows the data selection (PN9) for this down traffic channel. The **Data** softkey makes this the active function. Other selections include PN15, fixed 4-bit patterns, fixed patterns of ones and zeroes, user files, or external data.
- **CDVCC**: shows the value of the coded digital verification color code (hexadecimal 000). The **CDVCC** softkey makes this the active function.
- **RSVD**: shows that setting of the reserved field (hexadecimal 000). The grey text in this field indicates that you cannot change its value.

Softkey Location: **Mode > TDMA > NADC > Data Format Pattern Framed > Configure Timeslots > Timeslot Type > Down TCH > Configure Down TCH**

In the PDC Format

FREQUENCY 1.501 125 000 00 GHz		AMPLITUDE 0.00 dBm		TCH (PN9) ▶			
PDC		ENULP I/Q		RF ON MOD ON			
T				SW 87A4B			
PDC				CC 00			
Down TCH				Slot # 0			
R	P	TCH	SW	CC	SF	SACCH	TCH
4	2	112	20	8	1	21	112
R:	---		CC:		00		
P:	2 (always)		SF:		0 (always)		
TCH:	PN9		SACCH:		000000		
SW:	87A4B						
						SACCH 000000	

- R: ramp time is a 4-bit field. The grey text indicates that you cannot change the contents of this field.
- P: preamble is a 2-bit field. The grey text indicates that you cannot change the contents of this field.
- TCH: shows the data selection (PN9) for this down traffic channel. The TCH softkey makes this the active function. Other selections include PN15, fixed 4-bit patterns, fixed patterns of ones and zeroes, user files, or external data.
- SW: shows the value of the frame synchronization word (hexadecimal 87A4B). The SW softkey makes this the active function.
- CC: shows the value of the color code (00). The CC softkey makes this the active function.
- SF: shows the value of the steal flag (0). The grey text indicates that you cannot change it.
- SACCH: shows the value of the slow associated control channel (hexadecimal 000000). The SACCH softkey makes this the active function.

Softkey Location: **Mode > TDMA > PDC > Data Format Pattern Framed > Configure Timeslots > Timeslot Type > Down TCH > Configure Down TCH**

Configure Dummy Bearer 1

Pressing this softkey displays a menu of softkeys where you can configure a timeslot as a dummy bearer 1 burst. The following figure shows an example of the display for a dummy bearer 1 timeslot. In this configuration, the dummy bearer occupies the first half of a full slot. The dummy bearer 1 timeslot type is only available in the radio fixed part link.

FREQUENCY		1.881 792 000 00 GHz		AMPLITUDE		0.00 dBm	
L		DECT		ENULP I/Q		RF ON MOD ON	
						S E98A	
						A field 0000FFFF0000FFFF	
DECT							
Dummy Bearer (Half-Slot 1)				RFP	Slot # 0		
G	P	S	A	G	Unused		
16	16	16	64	128	240		
G: --				S: E98A			
P: AAAA (always)				A: 0000FFFF0000FFFF			

- G: there are two guard time fields. The grey text indicates that you cannot change the contents of these fields.
- P: the preamble is a 16-bit field. The grey text indicates that you cannot change the contents of this field.
- S: shows the contents (hexadecimal E98A) of the 16-bit synchronization word. The **S** softkey makes this the active function.
- A: shows the contents (hexadecimal 0000FFFF0000FFFF) of the A field. The **A field** softkey makes this the active function.

Softkey Location: Mode > TDMA > DECT > Data Format Pattern Framed > Configure Timeslots > Timeslot Type > Dummy Bearer 1 > Configure Dummy Bearer 1

Configure Dummy Bearer 2

Pressing this softkey displays a menu of softkeys where you can configure a timeslot as a dummy bearer 2 burst. The following figure shows an example of the display for a dummy bearer 2 timeslot. In this configuration, the dummy bearer occupies the first half of a full slot. The dummy bearer 1 timeslot type is only available in the radio fixed part link.

FREQUENCY 1.881 792 000 00 GHz		AMPLITUDE 0.00 dBm		S E98A	
T		DECT		RF ON MOD ON	
		ENULP I/Q		A field 0000FFFF0000FFFF	
DECT					
Dummy Bearer (Half-Slot 2)		RFP		Slot # 0	
Unused		G	P	S	A
240		16	16	16	64
G:	---	S:		E98A	
P:	AAAA (always)	A:		0000FFFF0000FFFF	

- G: there are two guard time fields. The grey text indicates that you cannot change the contents of these fields.
- P: shows the contents (hexadecimal AAA) of the 16-bit preamble field. The grey text indicates that you cannot change the contents of this field.
- S: shows the value (hexadecimal E98A) of the 16-bit synchronization word. The **S** softkey makes this the active function.
- A: shows the contents (hexadecimal 0000FFFF0000FFFF) of the A field. The **A field** softkey makes this the active function.

Softkey Location: **Mode > TDMA > DECT > Data Format Pattern Framed > Configure Timeslots > Timeslot Type > Dummy Bearer 2 > Configure Dummy Bearer 2**

Configure Frame

Pressing this softkey displays a menu of softkeys where you can control the entire selected frame. These frame-wide functions include scramble operating state, scramble seed data, secondary frame operating state, recalling and saving secondary frame states, and secondary frame state triggering options.

Softkey Location: **Mode > TDMA > *desired format* > Data Format Pattern Framed > Configure Timeslots > Configure Frame**

Configure Hardware

Pressing this softkey reveals a menu where you can select a particular hardware configuration.

Softkey Locations

Custom: **Mode > Custom > Configure Hardware**

Other Formats: **Mode > TDMA > *desired format* > Configure Hardware**

Configure Low Capacity

Pressing this softkey displays a menu of softkeys where you can configure a timeslot as a low capacity burst. The following figure shows an example of a radio fixed part low capacity timeslot. The portable part low capacity timeslot is identical except for the instrument preset values.

The screenshot shows a control interface with the following elements:

- FREQUENCY:** 1.881 792 000 00 GHz
- AMPLITUDE:** 0.00 dBm
- DECT** (selected)
- ENULP**, **I/Q**, **RF ON**, **MOD ON** (softkeys)
- A field:** 0000FFFF0000FFFF
- B field (PN9):** (indicated by a right-pointing arrow)
- DECT Low Capacity Packet Table:**

Low Capacity Packet				RFP		Slot # 0
G	P	S	A	B	Z	G
16	16	16	64	80	4	44
						Unused
						240
- Field Values:**
 - G: ---
 - P: AAAA (always)
 - S: E98A
 - A: 0000FFFF0000FFFF
 - B: PN9
 - Z: ---

- G: there are two guard time fields. The grey text indicates that you cannot change the contents of these fields.
- P: shows the contents (AAA) of the 16-bit preamble field. The grey text indicates that you cannot change the contents of this field.

- S: shows the value (hexadecimal E98A) of the 16-bit synchronization word. The **S** softkey makes this the active function.
- A: shows the contents (hexadecimal 0000FFFF0000FFFF) of the A field. The **A field** softkey makes this the active function.
- B: shows the contents (PN9) of the B field data selection. The **B field** softkey makes this the active function. Other selections include PN15, fixed 4-bit patterns, fixed patterns of ones and zeroes, DECT-specific patterns, user files, or external data.
- Z: the Z field is a 4-bit error detection field. The Z field repeats the last 4 bits of the B field. The grey text indicates that you cannot change the contents of this field.

Softkey Location: **Mode > TDMA > DECT > Data Format Pattern Framed > Configure Timeslots > Timeslot Type > Low Capacity > Configure Low Capacity**

Or: **Mode > TDMA > DECT > Data Format Pattern Framed > Configure Timeslots > Transmit Link RFP PP > Timeslot Type > Low Capacity > Configure Low Capacity**

Configure Low Capacity with Z Field

Pressing this softkey displays a menu of softkeys where you can configure a timeslot as a low capacity with Z field burst. The following figure shows an example of a radio fixed part low capacity with Z field timeslot. The portable part low capacity with Z field timeslot is identical except for the instrument preset values.

FREQUENCY		4.000 000 000 00 GHz		AMPLITUDE		-135.00 dBm		P AAAA	
L				RF OFF		MOD ON		S E98A	
								A field 0000FFFF0000FFFF	
DECT									
Low Capacity Packet with Z field RFP								Slot # 0	
G	P	S	A	B	Z	G	Unused		
16	16	16	64	80	44	40	240		
G:	---						A: 0000FFFF0000FFFF		
P:	AAAA						B: PN9		
S:	E98A						G: ---		
B field (PN9)									

- G: there are two guard time fields. The grey text indicates that you cannot change the contents of these fields.
- P: shows the contents (AAA) of the 16-bit preamble field. The grey text indicates that you cannot change the contents of this field.

- **S**: shows the value (hexadecimal E98A) of the 16-bit synchronization word. The **S** softkey makes this the active function.
- **A**: shows the contents (hexadecimal 0000FFFF0000FFFF) of the A field. The **A field** softkey makes this the active function.
- **B**: shows the contents (PN9) of the B field data selection. The **B field** softkey makes this the active function. Other selections include PN15, fixed 4-bit patterns, fixed patterns of ones and zeroes, DECT-specific patterns, user files, or external data.
- **X**: the X field is a 4-bit CRC calculation of the data contained within the B (data) field. The grey text indicates that you cannot change the contents of this field.
- **Z**: the Z field is a 4-bit error detection field. The Z field is a repeat of the same 4 bits in the X field. The grey text indicates that you cannot change the contents of this field.

Softkey Location: **Mode > TDMA > DECT > Data Format Pattern Framed > Configure Timeslots > Timeslot Type > Low Capacity > Configure Low Capacity with Z Field**

Or: **Mode > TDMA > DECT > Data Format Pattern Framed > Configure Timeslots > Transmit Link RFP PP > Timeslot Type > Low Capacity > Configure Low Capacity with Z Field**

Configure Normal

Pressing this softkey displays a menu of softkeys where you can configure a normal timeslot.

In the EDGE Format

The following figure shows an example of display graphics for a normal timeslot. The visual representation of the timeslot shows each field of the timeslot as it is defined by the EDGE format.

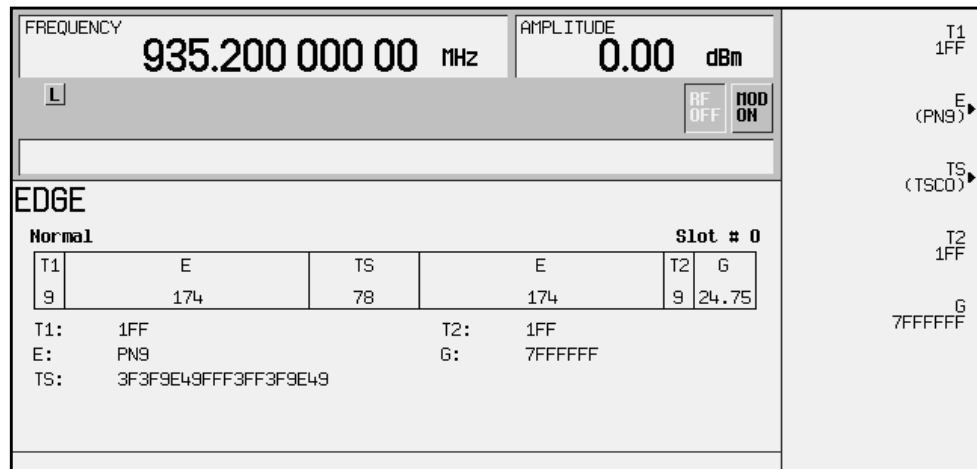

In this example:

- **T1**: shows the value (hexadecimal 1FF) for the 9-bit tail field. You can edit this value by pressing the **T1** softkey. However, if the guard time symbols of the previous timeslot do not match the **T1** symbols of the current timeslot, the burst shape may not be smooth (even if the previous timeslot is turned off).
- **E**: shows the current data selection (PN9). Press the **E** softkey to change the data selection. Other selections allowed include PN15, fixed 4-bit patterns, fixed patterns of ones and zeroes, user files, or external data.
- **TS**: shows the value (hexadecimal 3F3F9E49FFF3FF3F9E49) for the 78-bit training sequence. You can edit this value by pressing the **TS** softkey.
- **T2**: shows the value (hexadecimal 1FF) for the 9-bit tail field. You can edit this value by pressing the **T2** softkey. However, if the guard time and **T2** symbols of the current timeslot do not match, the burst shape may not be smooth.
- **G**: shows the value (hexadecimal 7FFFFFFF) for the guard time field. Guard time appears in the visual representation of the timeslot as a 24.75-bit field. In the actual implementation, the guard time field in timeslots 0 and 4 are 27 bits long and the remaining timeslots contain 24-bit fields. You can edit the guard time value by pressing the **G** softkey. However, If the guard time and **T2** symbols of the current timeslot and the **T1** symbols of the next timeslot do not match, the burst shape may not be smooth (even if the current timeslot is turned off).

Softkey Location: **Mode > TDMA > EDGE (Rev 8.3.0 Release 1999) > Data Format Pattern Framed > Configure Timeslots > Configure Normal**

In the GSM Format

The following figure shows an example of a normal timeslot as it is defined by the GSM format.

GSM						
Normal						Slot # 0
T	E	S	TS	S	E	G
3	57	1	26	1	57	8.25
T:	0 (always)		TS:	0970897		
E:	PN9		G:	---		
S:	0					

- **T**: shows the contents (hexadecimal zero) of the 3-bit tail field. The text in this field is grey, indicating that you cannot change the value for the tail bit field.
- **E**: shows the contents (PN9) of the data selection (encryption bits) for this timeslot. The **E** softkey makes this the active function. Other selections include PN15, fixed 4-bit patterns, fixed patterns of ones and zeroes, user files, or external data.
- **S**: shows the value (0) of both steal bits for this timeslot. The **S** softkey makes both steal bits the active function.
- **TS**: shows the contents (hexadecimal 0970897) of the 26-bit training sequence for this timeslot. The **TS** softkey makes this the active function.
- **G**: guard time appears in the visual representation of the timeslot as an 8.25-bit field. In the actual implementation, the guard time field in timeslots 0 and 4 are 9 bits long and the remaining timeslots contain 8 bit fields. (This implementation is documented in the GSM format “GSM REC. 05.10 Section 5.7” as follows: “Optionally, the BS may use a timeslot length of 157 bit periods on timeslots with TN=0 and 4, and 156 bit periods on timeslots with TN=1, 2, 3, 5, 6, 7, rather than 156.25 bit periods on all timeslots.”) The text in this field is grey, indicating that you cannot change the contents of the guard time field.

Softkey Location: **Mode > TDMA > GSM > Data Format Pattern Framed > Configure Timeslots > Configure Normal**

Configure Sync

In either the GSM or PHS format, pressing this softkey displays a menu of softkeys where you can configure a synchronization timeslot.

In the GSM Format

The following figure shows an example of a synchronization timeslot as it is defined by the GSM format.

T	E	TS	E	G
3	39	64	39	8.25

T: 0 (always) TS: B962040F2D45761B
E: PN9 G: --

- **T**: shows that both of the 3-bit tail fields are always hexadecimal zero. The text in this field is grey, indicating that you cannot change the contents of the tail bit fields.
- **E**: shows the contents (PN9) of the data selection (encryption bits) for this timeslot. The **E** softkey makes this the active function. Other selections include PN15, fixed 4-bit patterns, fixed patterns of ones and zeroes, user files, or external data.
- **TS**: shows the contents (hexadecimal B962040F2D45761B) of the 64-bit training sequence for this timeslot. The **TS** softkey makes this the active function.
- **G**: guard time appears in the visual representation of the timeslot as an 8.25-bit field. In the actual implementation, the guard time field in timeslots 0 and 4 are 9 bits long and the remaining timeslots contain 8 bit fields. (This implementation is documented in the GSM format “GSM REC. 05.10 Section 5.7” as follows: “Optionally, the BS may use a timeslot length of 157 bit periods on timeslots with TN=0 and 4, and 156 bit periods on timeslots with TN=1, 2, 3, 5, 6, 7, rather than 156.25 bit periods on all timeslots.”) The text in this field is grey, indicating that you cannot change the contents of the guard time field.

Softkey Location: **Mode > TDMA > GSM > Data Format Pattern Framed > Configure Timeslots > Timeslot Type > Sync > Configure Sync**

In the PHS Format

The following figure shows an example of a downlink synchronization burst timeslot as it is defined by the PHS format.

FREQUENCY 1.895 150 000 00 GHz		AMPLITUDE 0.00 dBm		UW 050EF2993					
L	PHS	ENULP	I/Q	RF ON	MOD ON				
PHS				CSID 20200020001					
SYNC		Downlink		Slot # 1					
R	SS	PR	UW	CI	CSID	PSID	IDLE	CRC	G
4	2	62	32	4	42	28	34	16	16
R:	--				CSID:	20200020001			
SS:	2 (always)				PSID:	0000001			
PR:	1999999999999999 (always)				IDLE:	000000000			
UW:	050EF2993				CRC:	(CI,CSID,PSID,IDLE)			
CI:	9 (always)				G:	--			
						IDLE		000000000	

- R: ramp time is a 4-bit field. The grey text indicates that you cannot change the contents of this field.
- SS: shows the contents (2) of the 2-bit start symbol field. The grey text indicates that you cannot change the contents of this field.
- PR: shows the contents (1999999999999999) of the 62-bit preamble field. The grey text indicates that you cannot change the contents of this field.
- UW: shows the value (hexadecimal 050EF2993) of the unique word. The **UW** softkey makes this the active function.
- CI: shows the contents (9) of the 4-bit identifier field. The grey text indicates that you cannot change the contents of this field.
- CSID: shows the value (hexadecimal 20200020001) of the cell station identification code. The **CSID** softkey makes this the active function.
- PSID: shows the value (hexadecimal 0000001) of the personal station identification code. The **PSID** softkey makes this the active function.
- IDLE: shows the value (hexadecimal 000000000) of the idle bit. The **IDLE** softkey makes this the active function.

- CRC: indicates that a cyclic redundancy check is performed on the channel identifier (CI), the cell station identification code (CSID), the personal station identification code (PSID), and the idle bit fields (IDLE). The grey text indicates that you cannot change the CRC.
- G: guard time is a 16-bit field. The grey text indicates that you cannot change the contents of this field.

Softkey Location: **Mode > TDMA > PHS > Data Format Pattern Framed > Configure Timeslots > Timeslot Type > SYNC > Configure SYNC**

Or: **Mode > TDMA > PHS > Data Format Pattern Framed > Configure Timeslots > Control Channel Dnlink Uplink > Timeslot Type > SYNC > Configure SYNC**

Configure TCH

Pressing this softkey displays a menu of softkeys where you can configure a timeslot as a traffic channel. The following figure shows a downlink traffic channel timeslot as it is defined by the PHS format.

NOTE

The uplink traffic channel timeslot is *not* identical (see “Configure Up TCH” on page 3-60).

The screenshot shows the PHS configuration interface. At the top, it displays 'FREQUENCY' as 1.895 150 000 00 GHz and 'AMPLITUDE' as 0.00 dBm. Below this are several control buttons: 'L', 'PHS', 'ENULP', 'I/Q', 'RF ON', and 'MOD ON'. On the right side, there are three status indicators: 'UW 3D4C', 'SA 8000', and 'TCH (PNS)' with a right-pointing arrow. The main section is titled 'PHS' and contains a table for 'Downlink Slot # 1'. The table has columns for R, SS, PR, UW, CI, SA, TCH, CRC, and G. The values are: R: --, SS: 2, PR: 19, UW: 3D4C, CI: 0, SA: 8000, TCH: PNS, CRC: (CI,SA,TCH), G: --. Below the table, there are labels for R, SS, PR, UW, CI, SA, TCH, CRC, and G with their respective values and some in grey text indicating they are not changeable.

R	SS	PR	UW	CI	SA	TCH	CRC	G
4	2	19	3D4C	0	8000	PNS	(CI,SA,TCH)	16

R: ramp time is a 4-bit field. The grey text indicates that you cannot change the contents of this field.

SS: the start symbol is a 2-bit field. The grey text indicates that you cannot change the contents of this field.

- PR: the preamble is a 6-bit field. The grey text indicates that you cannot change the contents of the this field.

UW: shows the contents (hexadecimal 3D4C) of the unique word. The UW softkey makes this the active function.

- **CI**: the channel identifier is a 4-bit field. The grey text indicates that you cannot change the contents of this field.
- **SA**: shows the contents (hexadecimal 8000) of the slow associated control channel. The **SA** softkey makes this the active function.
- **TCH**: shows the of the data selection (PN9) for this traffic channel. Other selections include PN15, fixed 4-bit patterns, fixed patterns of ones and zeroes, user files, or external data.
- **CRC**: shows that a cyclic redundancy check is performed on the channel identifier (CI), the slow associated control channel (SA), and the data fields (TCH). The grey text indicates that you cannot change the contents of this field.
- **G**: guard time is a 16-bit field. The grey text indicates that you cannot change the contents of this field.

Softkey Location: **Mode > TDMA > PHS > Data Format Pattern Framed > Configure Timeslots > Configure TCH**

Or: **Mode > TDMA > PHS > Data Format Pattern Framed > Configure Timeslots > Control Channel Dnlink Uplink > Configure TCH**

Configure Timeslots

Pressing this softkey displays a menu of softkeys. Use this and subsequent menus to configure the timeslots. This softkey is inactive with unframed data (see also: “[Data Format Pattern Framed](#)” on page 3-68).

Softkey Location: **Mode > TDMA > *desired format* > Data Format Pattern Framed > Configure Timeslots**

Configure Traffic Bearer

Pressing this softkey displays a menu of softkeys where you can configure a timeslot as a traffic bearer. The following figure shows an example of a radio fixed part traffic bearer timeslot. The portable part traffic bearer timeslot is identical except for the preset values.

FREQUENCY 1.881 792 000 00 GHz		AMPLITUDE 0.00 dBm		S E98A	
T		DECT		A field 0000FFFF0000FFFF	
		ENULP I/Q		RF ON	
				MOD ON	
DECT					
Basic Packet (Traffic Bearer)				RFP	
Slot # 0					
G	P	S	A	B	Z
16	16	16	64	320	4 44
G:	---		A:	0000FFFF0000FFFF	
P:	AAAA (always)		B:	PN9	
S:	E98A		Z:	---	

- G: there are two guard time fields. The grey text indicates that you cannot change the contents of these fields.
- P: the preamble is a 16-bit field. The grey text indicates that you cannot change the contents of this field.
- S: shows the contents (hexadecimal E98A) of the 16-bit synchronization word. The **S** softkey makes this the active function.
- A: shows the contents (hexadecimal 0000FFFF0000FFFF) of the A field. The **A field** softkey makes this the active function.
- B: shows the B field data selection (PN9). The **B field** softkey makes this the active function. Other selections include PN15, fixed 4-bit patterns, fixed patterns of ones and zeroes, DECT-specific patterns, user files, or external data.
- Z: the Z field is a 4-bit error detection field. The Z field repeats the last 4 bits of the B field. The grey text indicates that you cannot change the contents of this field.

Softkey Location: **Mode > TDMA > DECT > Data Format Pattern Framed > Configure Timeslots > Configure Traffic Bearer**

Or: **Mode > TDMA > DECT > Data Format Pattern Framed > Configure Timeslots > Transmit Link RFP PP > Configure Traffic Bearer**

Configure Traffic Bearer with Z Field

Pressing this softkey displays a menu of softkeys where you can configure a timeslot as a traffic bearer with Z field. The following figure shows an example of a radio fixed part traffic bearer with Z field timeslot. The portable part traffic bearer timeslot is identical except for the preset values.

FREQUENCY 4.000 000 000 00 GHz		AMPLITUDE -135.00 dBm		P AAAA	
T		RF OFF		MOD ON	
DECT		Traffic Bearer with Z field		RFP	
Slot # 0					
G	P	S	A	B	X Z G
16	16	16	64	320	4 4 40
G:	--		A:	0000FFFF0000FFFF	
P:	AAAA		B:	PN9	
S:	E98A		G:	--	
		A field 0000FFFF0000FFFF		B field (PN9)	

- G: there are two guard time fields. The grey text indicates that you cannot change the contents of these fields.
- P: the preamble is a 16-bit field. The grey text indicates that you cannot change the contents of this field.
- S: shows the contents (hexadecimal E98A) of the 16-bit synchronization word. The **S** softkey makes this the active function.
- A: shows the contents (hexadecimal 0000FFFF0000FFFF) of the A field. The **A field** softkey makes this the active function.
- B: shows the B field data selection (PN9). The **B field** softkey makes this the active function. Other selections include PN15, fixed 4-bit patterns, fixed patterns of ones and zeroes, DECT-specific patterns, user files, or external data.
- X: the X field is a 4-bit CRC calculation of the data contained within the B (data) field. The grey text indicates that you cannot change the contents of this field.
- Z: the Z field is a 4-bit error detection field. The Z field is a repeat of the same 4 bits in the X field. The grey text indicates that you cannot change the contents of this field.

Softkey Location: **Mode > TDMA > DECT > Data Format Pattern Framed > Configure Timeslots > Configure Traffic Bearer**

Or: **Mode > TDMA > DECT > Data Format Pattern Framed > Configure Timeslots > Transmit Link RFP PP > Configure Traffic Bearer**

Configure Up Control 1

Pressing this softkey displays a menu of softkeys where you can configure a timeslot as an uplink subslot 1 control timeslot. Up control 1 is half of a timeslot in length. Either subslot 1 or subslot 2 can be filled, but not both. The following figure shows an example of an uplink subslot 1 control timeslot as it is defined by the TETRA format.

FREQUENCY		399.998 000 00 MHz		AMPLITUDE		0.00 dBm		Data (PN9)	
T		TETRA		ENULP		I/Q		RF ON	
								MOD ON	
								TS 2743A743	
TETRA									
Uplink Control (Subslot 1)								Slot # 1	
R	T	Data	TS	Data	T	G	G		
34	4	84	30	84	4	15	255		
R:		---		TS:		2743A743			
T:		B (always)		G:		---			
Data:		PN9							

- R: ramp time is a 34-bit field. The grey text indicates that you cannot change the contents of the this field.
- T: shows the contents (hexadecimal B) of both of the 4-bit tail fields. The grey text indicates that you cannot change the content of these fields.
- Data: shows the data selection (PN9) for both 84-bit data fields. Other selections allowed include PN15, fixed 4-bit patterns, fixed patterns of ones and zeroes, user files, or external data.
- TS: shows the contents (hexadecimal 2743A743) of the 30-bit training sequence field. The TS softkey makes this the active function.
- G: there are two guard time fields: the first is a 15-bit field for subslot 1; the second is a 255-bit field that fills subslot 2. The grey text indicates that you cannot change the content of these fields.

Softkey Location: **Mode > TDMA > TETRA > Data Format Pattern Framed > Configure Timeslots > Timeslot Type > Up Control 1 > Configure Up Control 1**

Configure Up Control 2

Pressing this softkey displays a menu of softkeys where you can configure a timeslot as an uplink subslot 2 control timeslot. Up control 2 is half of a timeslot in length. Either subslot 1 or subslot 2 can be filled, but not both. The following figure shows an example of the timeslot as it is defined by the TETRA format.

FREQUENCY		399.998 000 00 MHz		AMPLITUDE		0.00 dBm		Data (PN9)	
T		TETRA		EMULP		I/Q		RF ON	
								TS 2743A743	
TETRA									
Uplink Control (Subslot 2)					Slot # 1				
G		R		T		Data		TS	
255		34		4		84		30	
								84	
R: --								TS: 2743A743	
T: B (always)								G: --	
Data: PN9									

- R: ramp time is a 34-bit field. The grey text indicates that you cannot change the content of this field.
- T: shows the content (hexadecimal B) of both of the 4-bit tail fields. The grey text indicates that you cannot change the content of these fields.
- Data: shows the data selection (PN9) for both 84-bit data fields. Other selections include PN15, fixed 4-bit patterns, fixed patterns of ones and zeroes, user files, or external data.
- TS: shows the contents (hexadecimal 2743A743) of the 30-bit training sequence field. The TS softkey makes this the active function.
- G: there are two guard time fields. The first is a 255-bit field that fills subslot 1. The second is a 15-bit field for subslot 2. The grey text indicates that you cannot change the content of these fields.

Softkey Location: **Mode > TDMA > TETRA > Data Format Pattern Framed > Configure Timeslots > Timeslot Type > Up Control 2 > Configure Up Control 2**

Configure Up Custom

Pressing this softkey displays a menu of softkeys where you can select the data pattern for an uplink custom timeslot. The following figure shows an example of a custom timeslot in the NADC format.

The screenshot shows a configuration interface for a custom timeslot in NADC format. At the top, the frequency is set to 4.000 000 000 00 GHz and the amplitude is -135.00 dBm. Below this, there are buttons for 'NADC', 'ENULP', 'I/Q', 'RF ON', and 'MOD ON'. The main section is titled 'NADC' and shows 'Up Custom' for 'Slot # 1'. A table displays the data pattern: 'Data' with a value of '312'. Below the table, there are fields for 'G:', 'R:', and 'Data: PN9'. On the right side, there are options for 'PH Sequence (PN9)', 'Other Patterns', 'User File', and 'Ext'.

- G: Guard time:
 - NADC: a 6-bit field
 - PDC: a 6-bit field
 - TETRA: a 14-bit field

The grey text indicates that you cannot change the content of this field.

- R: Ramp time:
 - NADC: a 6-bit field
 - PDC: a 4-bit field
 - TETRA: a 34-bit field

The grey text indicates that you cannot change the content of this field.

- Data: shows the data selection (PN9) for this custom timeslot. Other selections include PN15, fixed 4-bit patterns, fixed patterns of ones and zeroes, user files, or external data.

Softkey Location (NADC, PDC, or TETRA): **Mode > TDMA > desired format > Data Format Pattern Framed > Configure Timeslots > Timeslot Type > Up Custom > Configure Up Custom**

Configure Up Normal

Pressing this softkey displays a menu of softkeys where you can configure a timeslot as an uplink normal timeslot. The following figure shows an uplink normal timeslot as it is defined by the TETRA format.

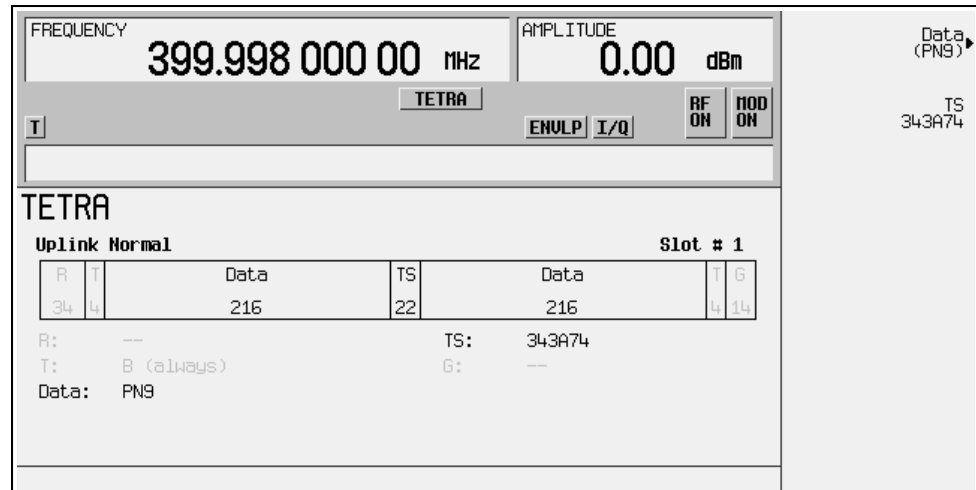

- R: ramp time is a 34-bit field. The grey text indicates that you cannot change the content of this field.
- T: shows the content (hexadecimal B) of both of the 4-bit tail fields. The grey text indicates that you cannot change the content of these fields.
- Data: shows the data selection (PN9) for both 216-bit data fields. Other selections include PN15, fixed 4-bit patterns, fixed patterns of ones and zeroes, user files, or external data.
- TS: shows the contents (hexadecimal 343A74) of the training sequence field. The TS softkey makes this the active function.
- G: guard time is a 14-bit field. The grey text indicates that you cannot change the content of this field.

Softkey Location: **Mode > TDMA > TETRA > Data Format Pattern Framed > Configure Timeslots > Timeslot Type > Up Normal > Configure Up Normal**

Configure Up TCH

In either the NADC or the PDC format, pressing this softkey displays a menu of softkeys where you can configure a timeslot as an uplink traffic channel.

In the NADC Format

The following figure shows an uplink traffic channel timeslot as defined by the NADC format.

The screenshot displays the NADC configuration interface. At the top, it shows the frequency as 4.000 000 000 00 GHz and the amplitude as -135.00 dBm. Below this, there are softkeys for 'NADC', 'ENULP', 'I/Q', 'RF ON', and 'MOD ON'. The main section is titled 'NADC' and 'Up TCH Slot # 1'. It contains a table with the following data:

G	R	Data	SYNC	Data	SACCH	CDVCC	Data
6	6	16	28	122	12	12	122

Below the table, the following parameters are listed:

- G: ---
- R: ---
- Data: PN9
- SYNC: A91DE4A
- SACCH: 000
- CDVCC: 000

On the right side of the screen, there are additional softkeys: 'Data (PN9)', 'SYNC A91DE4A', 'SACCH 000', and 'CDVCC 000'.

- **G**: guard time is a 6-bit field. The grey text indicates that you cannot change the content of this field.
- **R**: ramp time is a 6-bit field. The grey text indicates that you cannot change the content of this field.
- **Data**: shows the data selection (PN9) for this up traffic channel. The **Data** softkey makes this the active function. Other selections include PN15, fixed 4-bit patterns, fixed patterns of ones and zeroes, user files, or external data.
- **SYNC**: shows the value (hexadecimal A91DE4A) of the synchronization word. The **SYNC** softkey makes this the active function.
- **SACCH**: shows the value (hexadecimal 000) of the slow associated control channel. The **SACCH** softkey makes this the active function.
- **CDVCC**: shows the value (hexadecimal 000) of the coded digital verification color code. The **CDVCC** softkey makes this the active function.

Softkey Location: **Mode > TDMA > NADC > Data Format Pattern Framed > Configure Timeslots > Configure Up TCH**

In the PDC Format

The following figure shows an uplink traffic channel timeslot as defined by the PDC format.

FREQUENCY		1.501 125 000 00 GHz		AMPLITUDE		0.00 dBm	
T		PDC		ENULP		I/Q	
				RF ON		MOD ON	
PDC							
Up TCH				Slot # 0			
R	P	TCH	SW	CC	SF	SACCH	TCH
4	2	112	20	8	1	15	112
R: --		CC: 00		SF: 0 (always)		SACCH: 0000	
P: 2 (always)		SW: 785B4		G: --			
TCH: PN9							

TCH (PN9) →

SW 785B4

CC 00

SACCH 0000

- R: ramp time is a 4-bit field. The grey text indicates that you cannot change the content of this field.
- P: the preamble is a 2-bit field. The grey text indicates that you cannot change the content of this field.
- TCH: shows the data selection (PN9) for this uplink traffic channel. The **Data** softkey makes this the active function. Other selections include PN15, fixed 4-bit patterns, fixed patterns of ones and zeroes, user files, or external data.
- SW: shows the value (hexadecimal 785B4) of the frame synchronization word. The **SW** softkey makes this the active function.
- CC: shows the value (00) of the color code. The **CC** softkey makes this the active function.
- SF: shows the value (0) of the steal flag. The grey text indicates that you cannot change the content of this field.
- SACCH: shows that the slow associated control channel is set to 0000. The **SACCH** softkey makes this the active function.
- G: guard time is a 6-bit field. The grey text indicates that you cannot change the content of this field.

Softkey Location: **Mode > TDMA > PDC > Data Format Pattern Framed > Configure Timeslots > Configure Up TCH**

Configure Up VOX

Pressing this softkey displays a menu of softkeys where you can configure an uplink VOX traffic channel. The following figure shows an uplink VOX timeslot as it is defined by the PDC format.

FREQUENCY 1.501 125 000 00 GHz		AMPLITUDE 0.00 dBm		SW 785B4	
PDC		ENULP I/Q		RF ON	
T		HOD ON		CC 00	
PDC		SACCH 0000			
Up VOX		Slot # 0			
G	R	SW	CC	SF	SACCH
108	4	785B4	00	0	0000
G:	R:	P:	SW:	CC:	SF:
---	---	00 (always)	785B4	00	0 (always)
				SACCH:	G:
				0000	---

- **G**: there are two guard time fields. The guard time field at the beginning of the timeslot is a 108-bit field. The guard time field at the end of the timeslot is a 118-bit field. The grey text indicates that you cannot change the content of these fields.
- **R**: ramp time is a 4-bit field. The grey text indicates that you cannot change the content of this field.
- **P**: the preamble is a 2-bit field. The grey text indicates that you cannot change the content of this field.
- **SW**: shows the value (hexadecimal 785B4) of the frame synchronization word. The **SW** softkey makes this the active function.
- **CC**: shows the value (00) of the color code. The **CC** softkey makes this the active function.
- **SF**: shows the value (0) of the steal flag. The grey text indicates that you cannot change the value.
- **SACCH**: shows the value (0000) of the slow associated control channel. The **SACCH** softkey makes this the active function.

Softkey Location: **Mode > TDMA > PDC > Data Format Pattern Framed > Configure Timeslots > Timeslot Type > Up VOX > Configure Up VOX**

Control Channel Dnlink Uplink

Press this softkey to toggle between configuring uplink and downlink channels. To select downlink timeslots 1 through 4, choose downlink; to select uplink timeslots 1 through 4, choose uplink.

Any changes made to timeslots effect the timeslots that are turned on.

Default Value: Dnlink

Softkey Location: **Mode > TDMA > PHS > Data Format Pattern Framed > Configure Timeslots > Control Channel Dnlink Uplink**

Copy File

Press this softkey to display a menu where you can copy the file currently being edited to a new file and begin editing the new file.

Softkey Locations

Custom: **Mode > Custom > Data > User File > Edit File > Copy File**

Copy is also located in the **Create a File** menu.

Other Formats: **Mode > TDMA > *desired format* > Data > User File > Edit File > Copy File**

Copy is also located in the **Create a File** menu.

Create a File

Press this softkey to create a new bit file, named UNTITLED, which is then opened for editing with the Bit File Editor. Bit files contain any number of arbitrary bits of data.

Softkey Locations

Custom: **Mode > Custom > Data > User File > Create a File**

Other Formats: **Mode > TDMA > *desired format* > Data > User File > Edit File > Create a File**

CSID

Press this softkey to make the 42-bit cell station identification code (CSID) the active function. The current value for CSID appears in the CSID field near the bottom of the text area of the display.

Default Value: 20200020001

Softkey Location: **Mode > TDMA > PHS > Data Format Pattern Framed > Configure Timeslots > Timeslot Type > SYNC > Configure SYNC > CSID**

CSID is also located in the uplink **Configure SYNC** menu.

Custom

This softkey appears in two different situations, enabling you to either create a custom digital modulation, or create a custom timeslot type.

Creating Custom Digital Modulation

Pressing this softkey displays a menu of softkeys where you can create custom digital modulation. The custom modulation generator provides generic symbol building, variable symbol rates, and variable filter capabilities. You can define a modulation by selecting an existing modulation type or creating a unique modulation. You can select from several existing filters or create your own filter. You can also set the symbol rate and define the burst shape.

Softkey Location: **Mode > Custom**

Creating a Custom Timeslot Type

Press this softkey to select a custom timeslot type for the active timeslot. A custom timeslot is configured using an internally-generated data pattern, a downloaded sequence of bits stored in a user file, or by supplying external data. The custom timeslot is provided for flexibility; it is not a standard timeslot type.

When you select **Custom** for a timeslot, the visual representation of the timeslot pattern on the display updates.

Softkey Location (DECT, EDGE, GSM, or PHS): **Mode > TDMA > *desired format* > Data Format Pattern Framed > Configure Timeslots > Timeslot Type > Custom**

There are also custom timeslots for DECT portable part and PHS uplink transmissions.

Custom Off On

Press this softkey to toggle the operating state of the Real Time I/Q BaseBand Generator. Setting **Custom Off On** to **On** sets up the internal hardware to enable you to customize data patterns. You can choose from defined modulation types and filters, or create custom modulation formats for transmitting a continuous stream of an unframed data pattern.

Softkey Location: **Mode > Custom > Custom Off On**

Custom TS

Press this softkey to edit the selected training sequence code. The hexadecimal value for the training sequence will be displayed in the active entry area. Once modified, the new value will survive a power cycle, but at preset the default value will be restored. Pressing the TS0 through TS7 keys will set the Custom TS value to the value of the selected training sequence code.

Range: 0 through 3FFFFFFFFFFFFFFFFFFFFF

Default Value: TSC0

EDGE and GSM Softkey Location: **Mode > TDMA > *desired format* > Data Format Pattern Framed > Configure Timeslots > Configure Normal > TS > Custom TS**

D

D8PSK

This softkey appears in two different situations, enabling you to either select a modulation, or load a default I/Q map into the I/Q table editor.

Selecting a D8PSK Modulation

Press this softkey to select D8PSK (differential 8-state phase shift keying) for modulating a continuous stream of the selected data pattern. D8PSK modulation transmits data at the rate of 3 bits per symbol. The modulation selection is shown in the `Mod Type` field in the text area of the display, and also under the **Select** and **PSK** softkeys in the Modulation Type menus.

Softkey Locations

Custom: **Mode** > **Custom** > **Modulation Type** > **Select** > **PSK** > **D8PSK**

Other Formats: **Mode** > **TDMA** > *desired format* > **Modify Standard** > **Modulation Type** > **Select** > **PSK** > **D8PSK**

Loading a D8PSK I/Q Map into the I/Q Table Editor

Press this softkey to load a D8PSK (differential 8-state phase shift keying) I/Q map into the I/Q table editor. For details on editing I/Q maps, see “[Mapping Symbol Positions with the I/Q Table Editor](#)” on page 2 -15.

Softkey Locations

Custom: **Mode** > **Custom** > **Modulation Type** > **Define User I/Q** > **Load Default I/Q Map** > **PSK** > **D8PSK**

Other Formats: **Mode** > **TDMA** > *desired format* > **Modify Standard** > **Modulation Type** > **Define User I/Q** > **Load Default I/Q Map** > **PSK** > **D8PSK**

Data

For Unframed Data Transmission

Press this softkey to display a menu of choices for internal data generation (pseudorandom bit patterns, fixed 4-bit repeating sequences, set patterns of ones and zeroes, standard-specific patterns) for unframed transmission. You can choose to supply your own data (download a binary file or input data using the DATA INPUT connector).

NOTE

Pattern Repeat and Pattern Trigger functions are *not* available if you use either a PN data sequence, or an external data source.

Default Values

Custom: PN23

EDGE: PN9

Other Formats: PN23

Softkey Locations

Custom: **Mode** > **Custom** > **Data**

Other Formats: **Mode** > **TDMA** > *desired format* > **Data**

For Framed Data Transmission

Press this softkey to display a menu of choices for internal data generation (pseudorandom bit patterns, fixed 4-bit repeating sequences, set patterns of ones and zeroes, standard-specific patterns) for framed transmission. You can choose to supply your own data (download a binary file or input data using the DATA INPUT connector).

Default Values

- EDGE: PN9
- Other Formats: PN23

Softkey Locations

DECT: use the **B field** softkey to configure the traffic bearer and low capacity timeslot data fields, or the **Configure Custom** softkey to configure the custom data field.

EDGE and GSM: the **Data** softkey is also available for timeslot configuration; choose from the same menu of selections to configure the timeslot data fields.

NADC: the **Data** softkey is also available for timeslot configuration; choose from the same menu of selections to configure the timeslot data fields. **Data** is also located in the Configure Down TCH and Configure Up TCH menus.

PDC: use the **TCH** softkey to configure the timeslot data fields.

PHS: use the **TCH** softkey to configure the traffic channel timeslot data field, or the **Configure Custom** softkey to configure the custom data field.

TETRA: the **Data** softkey is also available for timeslot configuration; choose from the same menu of selections to configure the timeslot data fields.

Data Format Pattern Framed

Press this softkey to toggle the data between pattern and framed mode.

Data Format Pattern transmits a continuous stream of the selected data pattern (for information on selecting patterns, see “Data” on page 3-66).

Data Format Framed transmits a framed data pattern in the current format.

The **Data Format Pattern Framed** softkey is coupled to the **Burst Envelope Off On** softkey in the I/Q menu. When the data format is on, and **Data Format Framed** is selected, the ENVLP annunciator appears in the display (indicating that **Burst Envelope On** is also selected).

The following figure shows the display graphics for one of the formats. The timeslot pattern is displayed only when **Data Format Pattern Framed** is set to Framed.

The visual representation of the timeslot pattern shows which timeslots are on (active). Any configuration changes apply to the active timeslots.

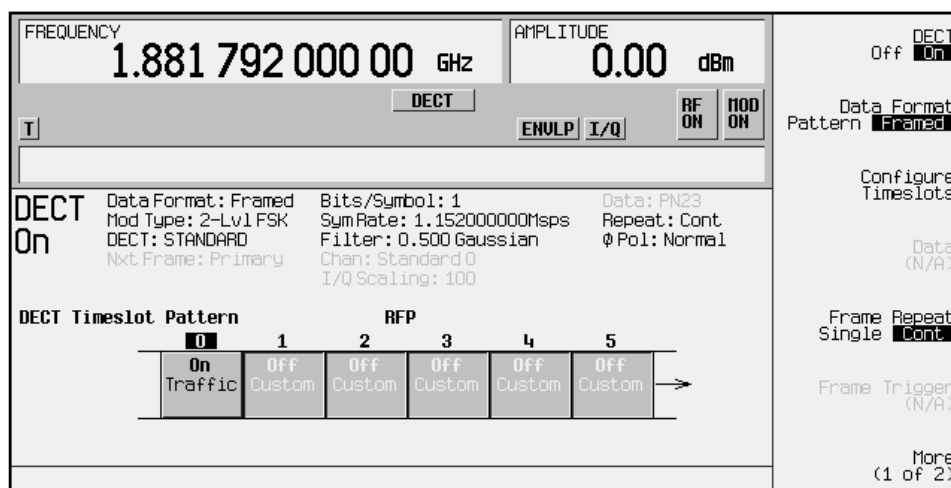

- **DECT On** (or other active format) this field shows whether the selected format is enabled (on) or not (off). In this example, the format is DECT.
- **Data Format:** displays the selected type of transmission (framed or pattern).
- **Mod Type:** displays the currently selected (2-Lvl FSK) type of internally-generated modulation.
- **DECT:** indicates whether the current structure of the DECT transmission follows DECT protocol (format) or not (modified).

- **Nxt Frame:** indicates the next triggered frame.

When secondary frame is on, after the primary frame triggers, this field changes to **Nxt Frame: Secondary**. In this example this field is grey, indicating that the secondary frame state is off.

- **Bits/Symbol:** indicates the number of bits per symbol required according to the selected format.
- **SymRate:** displays the current symbol rate.

In this example, the symbol rate is set according to the DECT format (1.152000000 Msps). This value can be changed in the Symbol Rate menu. An asterisk (*) next to the value indicates that it differs from the current format.

- **Filter:** shows the filter used.

This example shows a standard Gaussian filter with a BbT of 0.500. This value can be changed in the Filter menu. An asterisk (*) next to the BbT value indicates that it differs from the current format.

- **Chan:** shows the selected channel (channel 0 of the standard frequency channel band). Grey text indicates an inactive function.
- **I/Q Scaling:** shows the value (100%) of the I/Q scaling. Grey text indicates an inactive function.
- **Data:** shows the unframed data selection. In this example, the text in this field is grey, indicating an inactive function (framed mode is on). Other selections include other PN sequences, fixed 4-bit patterns, fixed patterns of ones and zeroes, standard-specific patterns, user files, or external data.
- **Repeat:** shows the current pattern repeat mode (continuous or single).
- **Phase Pol:** shows the direction of rotation of the phase modulation vector (normal or inverted mode).
- **Full-Rate:** in PDC format, this field indicates whether PDC is set to full-rate or half-rate (see “[Rate Full Half](#)” on page 3-141).

Also see: “[Configure Timeslots](#)” on page 3-53.

Default Value: Pattern

Softkey Location: **Mode > TDMA > *desired format* >
Data Format Pattern Framed**

Data Clk Out

Press this key to access a menu from which you can modify the output at the DATA CLKOUT rear panel BNC/SMB connector.

Softkey Location: **Mode > TDMA > EDGE (Rev 8.3.0Release 1999) >
BNC MUX Settings > Data Clk Out**

Data Out

Press this key to access a menu from which you can modify the output at the DATA OUT rear panel BNC/SMB connector.

Softkey Location: **Mode > TDMA > EDGE (Rev 8.3.0Release 1999) > BNC MUX Settings > Data Out**

DCS Base

Pressing this softkey selects DCS 1800 Base as the channel band for EDGE or GSM. DCS 1800 Base contains channels 512 through 885.

Softkey Location: **Mode > TDMA > *desired format* > Freq Channels > Channel Band > DCS Base**

DCS Mobile

Pressing this softkey selects DCS 1800 Mobile as the channel band for EDGE or GSM. DCS 1800 Mobile contains channels 512 through 885.

Softkey Location: **Mode > TDMA > *desired format* > Freq Channels > Channel Band > DCS Mobile**

DECT

Pressing this softkey displays a menu of softkeys where you can generate a data pattern formatted into either a framed structure (with the data bits in fields defined by the DECT protocol), or a sequence that can be output one or more times.

Softkey Location: **Mode > TDMA > DECT**

DECT Off On

Press this softkey to enable the DECT communications format. Setting **DECT Off On** to **On** sets up the internal hardware to generate the structure that follows the DECT format. The internal I/Q modulator generates GFSK digital modulation and the **DECT** and **I/Q** annunciators appear in the display. The RF carrier is modulated when you set **Mod On/Off** to **On**.

Setting **DECT Off On** to **On** presets the following softkeys in the I/Q menu: **I/Q Off On** is set to **On** and **I/Q Source** is set to **Int I/Q**. You can override these selections in the I/Q menu.

Default Value: Off

Softkey Location: **Mode > TDMA > DECT > DECT Off On**

Dect Patterns

Pressing this softkey accesses a menu of DECT-specific data pattern selections. The following internally-generated patterns are available:

- **FDEV1_HS** - (frequency deviation, half slot) 8 bits: repetitive pattern of 1, 0, 1, 0... followed by 32 ones, 32 zeroes, and 8 bits: repetitive pattern of 1, 0, 1, 0...
- **FDEV1_FS** - (frequency deviation, full slot) 128 bits: repetitive

pattern of 1, 0, 1, 0... followed by 64 ones, 64 zeroes, and 64 bits:
repetitive pattern of 1, 0, 1, 0...

- FDEV2_FS - (frequency deviation, full slot) 128 bits: repetitive pattern of 1, 0, 1, 0... followed by 64 ones, 64 zeroes, and 64 bits: repetitive pattern of 1, 0, 1, 0...

FACCuracy - (frequency accuracy) repetitive pattern of 4 ones followed by 4 zeroes

- DM1 - All ones
- DM0 - All zeroes

Softkey Location: **Mode > TDMA > DECT > Data Format Pattern Framed > Configure Timeslots > Configure Traffic Bearer > B field > Dect Patterns**

Dect Patterns is also located in the B field menus found in the portable part Configure Traffic Bearer menu and the radio fixed part and portable part Low Capacity menus, and also in the radio fixed part and portable part Configure Custom menus.

Define User Burst Shape

Press this softkey to display a table editor where you can edit the rise and fall shapes of waveforms. For information on using this feature, see [“Customizing the Burst Shape”](#) on page 2-7.

Softkey Locations

Custom: **Mode > Custom > Burst Shape > Define User Burst Shape**

Other Formats: **Mode > TDMA > *desired format* > Modify Standard > Burst Shape > Define User Burst Shape**

Define User FIR

Press this softkey to display a table editor where you can create and modify FIR filters.

The FIR table editor allows a maximum filter length of 1024 taps (32 symbols with a maximum oversampling ratio of 32), but the instrument hardware is limited to 32 symbols, an oversample ratio between 4 and 16, and 256 coefficients. If you enter more than 32 symbols, the instrument cannot use the filter. Entering more than 16 symbols will decrease the maximum symbol rate by half. If the oversample ratio is different from the internal, optimally selected one, the filter is resampled to the most optimal oversample ratio. For details on using the FIR table editor, see [“Creating a User-Defined FIR Filter by Entering Values”](#) on page 2 -26.

Softkey Locations

Custom: **Mode > Custom > Filter > Define User FIR**

Other Formats: **Mode** > TDMA > *desired format* > **Modify Standard** > **Filter** > **Define User FIR**

Define User FSK

Pressing this softkey displays the FSK table editor, where you can define custom asymmetric (or symmetric) FSK modulation patterns. The FSK table editor enables you to define a frequency deviation and load a default symmetric FSK pattern (2-Lvl, 4-Lvl, 8-Lvl, 16-Lvl, or C4FM) or create a modulation pattern based on user-defined frequency values.

Softkey Locations

Custom: **Mode** > **Custom** > **Modulation Type** > **Define User FSK**

Other Formats: **Mode** > TDMA > *desired format* > **Modify Standard** > **Modulation Type** > **Define User FSK**

Define User I/Q

Pressing this softkey displays the I/Q table editor, where you can directly define symbol positions. The I/Q table editor enables you to create custom constellation diagrams that you can save to an I/Q file catalog (see “[Mapping Symbol Positions with the I/Q Table Editor](#)” on page 2 -15).

Softkey Locations

Custom: **Mode** > **Custom** > **Modulation Type** > **Define User I/Q**

Other Formats: **Mode** > TDMA > *desired format* > **Modify Standard** > **Modulation Type** > **Define User I/Q**

Delete

Press this softkey to display a menu where you can select different methods of removing bits.

Delete is located in the Bit File Editor menus.

Delete All Rows

Press this softkey to erase the current table values.

CAUTION

Be careful using this softkey because there is no *undo* key.

Delete All Rows is located in the table editor menus.

Delete Bits

Press this softkey to delete the specified number of bits from the currently highlighted position.

Delete Bits is located in the Bit File Editor menus.

Delete Row

Press this softkey to delete the highlighted row in a table editor.

Delete Row is located in the table editor menus.

Delete to Beginning

Press this softkey to delete all bits from the currently highlighted bit to the beginning of the file.

Delete to Beginning is located in the Bit File Editor menus.

Delete to End

Press this softkey to delete all bits from the currently highlighted bit to the end of the file.

Delete to End is located in the Bit File Editor menus.

Diff Data Encode Off On

Press this softkey to change the operational state of the signal generator's differential data encoding.

For a detailed explanation of differential data encoding, see "[Understanding Differential Data Encoding](#)" on page 6-10.

Softkey Locations

Custom: **Mode** > **Custom** > **Diff Data Encode Off On**

GSM: **Mode** > **TDMA** > **GSM** > **Modify Standard** > **Diff Data Encode Off On**

Differential Encoding Off On

Press this softkey to change the operational state of the user-defined Differential Encoding.

For a detailed explanation of differential encoding, see "[Understanding Differential Encoding](#)" on page 6-11.

For information on using the Differential State Map editor, see "[Mapping Custom Differential Encoding](#)" on page 2 -11.

Softkey Locations

Custom: **Mode** > **Custom** > **Modulation Type** > **Define User I/Q** > **Differential Encoding Off On**

Or: **Mode** > **Custom** > **Modulation Type** > **Define User FSK** > **Differential Encoding Off On**

Other Formats: **Mode** > **TDMA** > *desired format* > **Modify Standard** > **Modulation Type** > **Define User I/Q** > **Differential Encoding Off On**

Or: **Mode** > **TDMA** > *desired format* > **Modify Standard** > **Modulation Type** > **Define User FSK** > **Differential Encoding Off On**

Display Burst Shape

Displays a graph of the rise and fall burst shapes.

Softkey Locations

Custom: **Mode** > **Custom** > **Burst Shape** > **Define User Burst Shape** > **Display Burst Shape**

Other Formats: **Mode** > **TDMA** > *desired format* > **Modify Standard** > **Burst Shape** > **Define User Burst Shape** > **Edit Fall Shape**

Display FFT

Press this softkey to display a graphical representation of the filter frequency response (calculated using a fast Fourier transform). The following is an example of the frequency response of a Root Nyquist filter with an oversample ratio of 4.

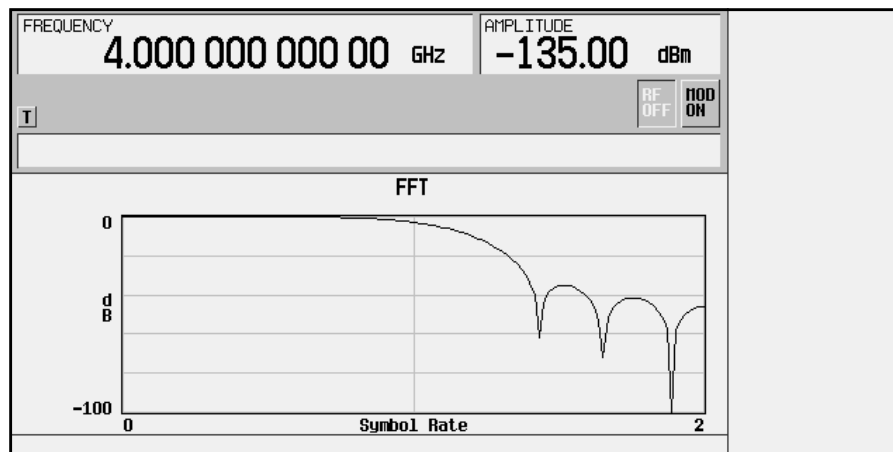

Softkey Locations

Custom: **Mode** > **Custom** > **Filter** > **Define User FIR** > **Load Default FIR** > *desired filter* > **Generate** > **Display FFT**

Other Formats: **Mode** > **TDMA** > *desired format* > **Modify Standard** > **Filter** > **Define User FIR** > **Load Default FIR** > *desired filter* > **Generate** > **Display FFT**

Display Impulse Response

Press this softkey to display a graphical representation of the filter impulse response in time. The following is an example of the impulse response of a Root Nyquist filter with an oversample ratio of 4.

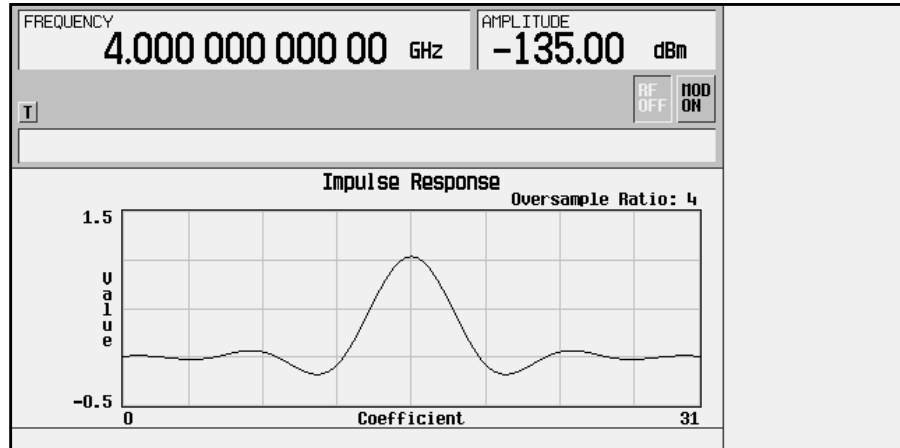

Softkey Locations

Custom: Mode > Custom > Filter > Define User FIR > Load Default FIR > *desired filter* > Generate > Display Impulse Response

Other Formats: Mode > TDMA > *desired format* > Modify Standard > Filter > Define User FIR > Load Default FIR > *desired filter* > Generate > Display Impulse Response

Display I/Q Map

Pressing this softkey displays an I/Q constellation map diagram of the current set of I/Q points. You can use this display as you create or modify a constellation map in the I/Q table editor (as described in [“Mapping Symbol Positions with the I/Q Table Editor”](#) on page 2 -15).

Softkey Locations

Custom: Mode > Custom > Modulation Type > Define User I/Q > Display I/Q Map

Other Formats: Mode > TDMA > *desired format* > Modify Standard > Modulation Type > Define User I/Q > Display I/Q Map

DM0

Press this softkey to select a binary data pattern that consists of all zeroes. This internally-generated data pattern is available for framed transmissions only. When **DM0** is selected, both the **B field** and the **Dect Patterns** softkeys show this selection, and **DM0** appears in the **B field**, near the bottom of the text area of the display.

Softkey Location: **Mode > TDMA > DECT > Data Format Pattern Framed > Configure Timeslots > Configure Traffic Bearer > B field > Dect Patterns > DM0**

DM0 is also located in the Dect Patterns menus found in the portable part Configure Traffic Bearer menu and the radio fixed part and portable part Low Capacity menus, and also in the radio fixed part and portable part Configure Custom menus.

DM1

Press this softkey to select a binary data pattern that consists of all ones. This internally-generated data pattern is available for framed transmissions only. When **DM1** is selected, both the **B field** and the **Dect Patterns** softkeys show this selection, and **DM1** appears in the **B field**, near the bottom of the text area of the display.

Softkey Location: **Mode > TDMA > DECT > Data Format Pattern Framed > Configure Timeslots > Configure Traffic Bearer > B field > Dect Patterns > DM1**

DM1 is also located in the Dect Patterns menus found in the portable part Configure Traffic Bearer menu and the radio fixed part and portable part Low Capacity menus, and also in the radio fixed part and portable part Configure Custom menus.

Dn Custom Cont

Press this softkey to select a downlink continuous custom timeslot type for the active timeslot, which is configured using an internally-generated data pattern, a downloaded sequence of bits stored in a user file, or by supplying external data. This timeslot is provided for flexibility; it is not a standard TETRA timeslot. You cannot mix downlink and uplink timeslots. If a timeslot is designated as uplink, it changes to downlink if any other timeslot is designated as downlink. The following table shows the change to a frame designated as uplink when you select either continuous downlink or discontinuous downlink. When you select a timeslot, the display updates.

From Uplink Timeslot	To Continuous Downlink Timeslot	To Discontinuous Downlink Timeslot
Up Custom	Dn Custom Cont	Dn Custom Disc
Up Control 1	Dn Custom Cont	Dn Custom Disc
Up Control 2	Dn Custom Cont	Dn Custom Disc

Softkey Location: **Mode > TDMA > TETRA > Data Format Pattern Framed > Configure Timeslots > Timeslot Type > Dn Custom Cont**

Dn Custom Disc

Press this softkey to select a downlink discontinuous custom timeslot type for the active timeslot, which is configured using an internally-generated data pattern, a downloaded sequence of bits stored in a user file, or by supplying external data. This timeslot is provided for flexibility; it is not a standard TETRA timeslot. You cannot mix downlink and uplink timeslots. If a timeslot is designated as uplink, it changes to downlink if any other timeslot is designated as downlink. The following table shows the change to a frame designated as uplink when you select either continuous downlink or discontinuous downlink. When you select a timeslot, the display updates.

From Uplink Timeslot	To Continuous Downlink Timeslot	To Discontinuous Downlink Timeslot
Up Custom	Dn Custom Cont	Dn Custom Disc
Up Control 1	Dn Custom Cont	Dn Custom Disc
Up Control 2	Dn Custom Cont	Dn Custom Disc
Up Normal	Dn Normal Cont	Dn Normal Disc

Softkey Location: **Mode > TDMA > TETRA > Data Format Pattern Framed > Configure Timeslots > Timeslot Type > Dn Custom Disc**

Dn Normal Cont

Press this softkey to select downlink continuous normal as the timeslot type for the active timeslot.

You cannot mix downlink and uplink timeslots. When a timeslot is designated as uplink, it changes to downlink if any other timeslot is designated as downlink. The following table shows the change to a frame designated as uplink when you select either continuous downlink or discontinuous downlink. When you select a timeslot, the display updates.

From Uplink Timeslot	To Continuous Downlink Timeslot	To Discontinuous Downlink Timeslot
Up Custom	Dn Custom Cont	Dn Custom Disc
Up Control 1	Dn Custom Cont	Dn Custom Disc
Up Control 2	Dn Custom Cont	Dn Custom Disc
Up Normal	Dn Normal Cont	Dn Normal Disc

Softkey Location: **Mode > TDMA > TETRA > Data Format Pattern Framed > Configure Timeslots > Timeslot Type > Dn Normal Cont**

Dn Normal Disc

Press this softkey to select downlink discontinuous normal as the timeslot type for the active timeslot.

You cannot mix downlink and uplink timeslots. If a timeslot is designated as uplink, it changes to downlink if any other timeslot is designated as downlink. The following table shows the change to a frame designated as uplink when you select either continuous downlink or discontinuous downlink. When you select a timeslot, the display updates.

From Uplink Timeslot	To Continuous Downlink Timeslot	To Discontinuous Downlink Timeslot
Up Custom	Dn Custom Cont	Dn Custom Disc
Up Control 1	Dn Custom Cont	Dn Custom Disc
Up Control 2	Dn Custom Cont	Dn Custom Disc
Up Normal	Dn Normal Cont	Dn Normal Disc

Softkey Location: **Mode > TDMA > TETRA > Data Format Pattern Framed > Configure Timeslots > Timeslot Type > Dn Normal Cont**

Dn Sync Cont

Press this softkey to select downlink continuous synchronization as the timeslot type for the active timeslot.

You cannot mix downlink and uplink timeslots. When a timeslot is designated as uplink, it changes to downlink if any other timeslot is designated as downlink. The following table shows the change to a frame designated as uplink when you select either continuous downlink or discontinuous downlink.

From Uplink Timeslot	To Continuous Downlink Timeslot	To Discontinuous Downlink Timeslot
Up Custom	Dn Custom Cont	Dn Custom Disc
Up Control 1	Dn Custom Cont	Dn Custom Disc
Up Control 2	Dn Custom Cont	Dn Custom Disc
Up Normal	Dn Normal Cont	Dn Normal Disc

When you select **Dn Sync Cont** for a timeslot, the visual representation of the timeslot pattern updates.

Softkey Location: **Mode > TDMA > TETRA > Data Format Pattern Framed > Configure Timeslots > Timeslot Type > Dn Sync Cont**

Dn Sync Disc

Press this softkey to select downlink discontinuous synchronization as the timeslot type for the active timeslot.

You cannot mix downlink and uplink timeslots. When a timeslot is designated as uplink, it changes to downlink if any other timeslot is designated as downlink. The following table shows the change to a frame designated as uplink when you select either continuous downlink or discontinuous downlink.

From Uplink Timeslot	To Continuous Downlink Timeslot	To Discontinuous Downlink Timeslot
Up Custom	Dn Custom Cont	Dn Custom Disc
Up Control 1	Dn Custom Cont	Dn Custom Disc
Up Control 2	Dn Custom Cont	Dn Custom Disc
Up Normal	Dn Normal Cont	Dn Normal Disc

When you select **Dn Sync Disc** for a timeslot, the visual representation of the timeslot pattern updates.

Softkey Location: **Mode > TDMA > TETRA > Data Format Pattern Framed > Configure Timeslots > Timeslot Type > Dn Sync Cont**

Down Custom

Press this softkey to select a downlink custom timeslot type for the active timeslot. A downlink custom timeslot is configured using an internally-generated data pattern, a downloaded sequence of bits stored in a user file, or by supplying external data.

You cannot mix downlink and uplink timeslots. When a timeslot is designated as uplink, it changes to downlink if any other timeslot is designated as downlink. The downlink custom timeslot is provided for flexibility; it is not a standard timeslot type.

When you have selected **Down Custom** for a timeslot, the visual representation of the timeslot pattern updates.

Softkey Locations

NADC and PDC: **Mode > TDMA > *desired format* > Data Format Pattern Framed > Configure Timeslots > Timeslot Type > Down Custom**

Downlink MCS-1

Press this softkey to select a downlink packet data traffic channel with block type 5 that is in compliance with GSM 05.03.

Softkey Location: **Mode > TDMA > GSM > Data Format Pattern Framed > Configure Timeslots > Configure Normal > E > Multiframe Channel > Downlink MCS-1**

Downlink MCS-5

Press this softkey to select a downlink packet data traffic channel with block type 9 that is in compliance with GSM 05.03. The MCS5 radio block contains a single RLC data block of 448 bits with a code rate of 0.37. This ensures that the maximum amount of Forward Error Correction (FEC) has been applied to the data.

Softkey Location: **Mode > TDMA > EDGE (Rev 8.3.0 Release 1999) > Data Format Pattern Framed > Configure Timeslots > Configure Normal > E > Multiframe Channel > Downlink MCS-5**

Downlink MCS-9

Press this softkey to select a downlink packet data traffic channel with block type 13 that is in compliance with GSM 05.03. The MCS9 radio block contains two RLC data blocks of 592 bits with a code rate of 1.0. No Forward Error Correction (FEC) has been applied to the data, thus reducing the overhead and enabling the fastest data rate transmission.

Softkey Location: **Mode > TDMA > EDGE (Rev 8.3.0 Release 1999) > Data Format Pattern Framed > Configure Timeslots > Configure Normal > E > Multiframe Channel > Downlink MCS-9**

Down TCH

Press this softkey to select downlink traffic channel (base station to mobile) as the timeslot type for the active timeslot. Downlink timeslots cannot be mixed with uplink timeslots.

You cannot mix downlink and uplink timeslots. When a timeslot is designated as uplink, it changes to downlink if any other timeslot is designated as downlink.

When you select **Down TCH**, the frame pattern is output with continuous RF power. Power is on during off timeslots (according to the standard) and a continuous pattern of binary ones is sent during off timeslots.

When you select **Down TCH** for a timeslot, the visual representation of the timeslot pattern updates.

NADC and PDC: **Mode > TDMA > *desired format* > Data Format Pattern Framed > Configure Timeslots > Timeslot Type > Down TCH**

Down TCH All

Press this softkey to select downlink traffic channel (base station to mobile) as the timeslot type for all timeslots. When you select **Down TCH All**, the frame pattern is output with continuous RF power. Power is on during off timeslots (according to the standard) and a continuous pattern of binary ones is sent during off timeslots. When all of the timeslots are off, RF power is off.

When you select **Down TCH All**, the visual representation of the timeslot pattern updates.

Softkey Locations

NADC and PDC: **Mode > TDMA > *desired format* > Data Format Pattern Framed > Configure Timeslots > Timeslot Type > Down TCH All**

Dummy

Press this softkey to select dummy as the timeslot type for the active timeslot. The dummy burst is used as filler information for unused timeslots on the forward link.

When you select **Dummy** for a timeslot, the visual representation of the timeslot pattern updates.

Softkey Location: **Mode > TDMA > GSM > Data Format Pattern Framed > Configure Timeslots > Timeslot Type > Dummy**

Dummy Bearer 1

Press this softkey to select dummy bearer 1 as the timeslot type for the active timeslot. When you have selected **Dummy Bearer 1** for a timeslot, the visual representation of the timeslot type updates.

Softkey Location: **Mode > TDMA > DECT > Data Format Pattern Framed > Configure Timeslots > Timeslot Type > Dummy Bearer 1**

Dummy Bearer 2

Press this softkey to select dummy bearer 2 as the timeslot type for the active timeslot. When you have selected **Dummy Bearer 2** for a timeslot, the visual representation of the timeslot type on the display updates.

Softkey Location: **Mode > TDMA > DECT > Data Format Pattern Framed > Configure Timeslots > Timeslot Type > Dummy Bearer 2**

E

E

Pressing this softkey displays a menu of data generation choices for configuring the EDGE or GSM timeslot encryption bit fields:

- Internal data (PN9, PN15, fixed, 4-bit repeating sequences, set patterns of ones and zeroes).
- Your own data (download a binary file, or input data using the DATA INPUT connector).

Default Value: PN9

Softkey Location: **Mode > TDMA > *desired format* >**

Data Format Pattern Framed > Configure Timeslots > Configure Normal > E

E is also located in the Configure Sync and Configure Access menus.

E Field Data

Use this softkey to select a signal that contains data only for the output at the rear panel DATA OUT port.

Softkey Location: **Mode > TDMA > EDGE (Rev 8.3.0Release 1999) > BNC MUX Settings > Data Out > E Field Data**

E-GSM Base

Press this softkey to select E-GSM 900 Base as the frequency band for EDGE or GSM. E-GSM 900 Base contains channels 0 through 124 and 975 through 1023.

Softkey Location: **Mode > TDMA > *desired format* > Freq Channels > Channel Band > E-GSM Base**

E-GSM Mobile

Press this softkey to select E-GSM 900 Mobile as the frequency band for EDGE or GSM. E-GSM 900 Mobile contains channels 0 through 124 and 975 through 1023.

Softkey Location: **Mode > TDMA > *desired format* > Freq Channels > Channel Band > E-GSM Mobile**

E-TCH/F43.2

This key selects an enhanced circuit switched full rate traffic channel for 43.2 kbits/s user data per GSM 05.03. The length of the RLC data block for this channel is 640 bits.

Softkey Location: **Mode > TDMA > EDGE (Rev 8.3.0 Release 1999) > Data Format Pattern Framed > Configure Timeslots > Configure Normal > E > Multiframe Channel > E-TCH/F43.2**

EDGE

This softkey appears in two different locations, as filter and modulation selections.

Selecting the EDGE Filter Press the **EDGE** softkey in the **Select (filter)** menu to select the EDGE pre-modulation filter (linearized Gaussian). The EDGE filter is the default selection as specified by the EDGE format.

Softkey Location: **Mode > TDMA > EDGE (Rev 8.3.0 Release 1999) > Modify Standard > Filter > Select > EDGE**

Selecting EDGE Modulation Press the **EDGE** softkey in the **Select (modulation type)** menu to enable EDGE modulation ($3\pi/8$ rotating 8PSK). EDGE modulation transmits data at the rate of 3 bits per symbol. EDGE modulation is the default selection as specified by the EDGE format.

Softkey Location: **Mode > TDMA > EDGE (Rev 8.3.0 Release 1999) > Modify Standard > Modulation Type > Select > PSK > EDGE**

EDGE (Rev 8.3.0 Release 1999)

Press the **EDGE (Rev 8.3.0 Release 1999)** softkey in the TDMA menu to access the softkey menus for utilizing the EDGE format. Accessing lower level menus to this softkey will provide capabilities for customizing the modulation, filter, burst shape, and other attributes of the protocol.

Softkey Location: **Mode > TDMA > EDGE (Rev 8.3.0 Release 1999)**

EDGE Off On

Press this softkey to enable the EDGE communications format. Setting **EDGE Off On** to **On** sets up the internal hardware to generate a signal that follows the EDGE format. The internal I/Q modulator generates $3\pi/8$ rotating 8PSK digital modulation and the **EDGE** and **I/Q** annunciators are turned on in the display. Although the digital modulation is enabled with this softkey, the RF carrier is modulated by the enabled modulation only when you have also set **Mod On/Off** to **On**.

Setting **EDGE Off On** to **On** presets the following softkeys in the I/Q

menu: **I/Q Off On** is set to **On** and **I/Q Source** is set to **Int I/Q**. You can override these selections in the **I/Q** menu.

Default Value: Off

Softkey Location: **Mode > TDMA > EDGE (Rev 8.3.0 Release 1999) > EDGE Off On**

Edit Fall Shape

When editing a burst shape, press this softkey to make the Fall Shape Editor the active function.

Note that this softkey is available when the Rise Shape Editor is the active function; when the Fall Shape Editor is the active function, this softkey toggles to **Edit Rise Shape**.

For information on using this feature, see “[Customizing the Burst Shape](#)” on page 2-7.

Softkey Locations

Custom: **Mode > Custom > Burst Shape > Define User Burst Shape > Edit Fall Shape**

Other Formats: **Mode > TDMA > *desired format* > Modify Standard > Burst Shape > Define User Burst Shape > Edit Fall Shape**

Edit File

Press this softkey to begin editing the selected file. You are asked to confirm converting binary files to bit files for editing.

NOTE

There is no undo capability; bit files are saved after every modification.

Softkey Locations

Custom: **Mode > Custom > Data > User File > Edit File**

Other Formats: **Mode > TDMA > *desired format* > Data > User File > Edit File**

Editing Keys

Press this softkey to display a menu of softkeys for clearing text and toggling insert and replace mode.

Softkey Locations

Custom: **Mode > Custom > Data > User File > Edit File > Copy File > Editing Keys**

Editing Keys is also located under **Rename**

Other Formats: **Mode > TDMA > *desired format* > Data > User File >**

Edit File > Copy File > Editing Keys

Editing Keys is also located under **Rename**

Edit Item

Press this softkey to select the highlighted value for editing in the current table editor. After you select the item this way, you can use the front panel RPG and arrow keys to edit the value.

Edit Item is located in table editor menus.

Edit Rise Shape

When editing a burst shape, press this softkey to make the Rise Shape Editor the active function.

Note that this softkey is available when the Fall Shape Editor is the active function; when the Rise Shape Editor is the active function, this softkey toggles to [Edit Fall Shape](#).

For information on using this feature, see “[Customizing the Burst Shape](#)” on page 2-7.

Softkey Locations

Custom: **Mode > Custom > Burst Shape > Define User Burst Shape > Edit Fall Shape > Edit Rise Shape**

EDGE or GSM: **Mode > TDMA > *desired format* > Modify Standard > Burst Shape > Define User Burst Shape > Edit Fall Shape > Edit Rise Shape**

ET

Press this softkey to make the 8-bit extended tail field (ET) the active function. The default hexadecimal value reflects the GSM format; the current value for ET appears in the ET field near the bottom of the text area of the display.

Default Value: 3A

Softkey Location: **Mode > TDMA > GSM > Data Format Pattern Framed > Configure Timeslots > Timeslot Type > Access > Configure Access > ET**

Event 1

This key accesses a menu from which you can select the output signal of the EVENT 1 rear panel BNC/SMB connector.

Default Value: Multiframe Trigger

Softkey Location: **Mode > TDMA > EDGE (Rev 8.3.0 Release 1999) > BNC MUX Settings > Event 1**

Ext

This softkey appears in several places: in the Data menu, in the Pattern Trigger menu, and in the Frame Trigger Menu.

NOTE

Pattern Repeat and Pattern Trigger functions are *not* available if you use either a PN data sequence, or an external data source.

In the Data Menu In the Data menu, pressing Ext selects an external user signal as the modulating data stream. With Ext selected, apply the data signal to the DATA INPUT connector.

When you select Ext as a data pattern for modulated transmissions that are *not* framed, Ext appears in the Data field in the top line of the text area of the display.

When you select Ext to configure the timeslot data fields, EXT appears in either the Data field, located near the bottom of the text area of the display, or, for the following for the following formats:

In the B field (DECT), E field (GSM), or TCH field (PDC and PHS), also near the bottom of the text area.

In framed mode, the external data is gated to the data regions of the timeslot.

Softkey Locations

Custom: Mode > Custom > Data > Ext

DECT: Mode > TDMA > DECT > Data > Ext

Or: Mode > TDMA > DECT > Data Format Pattern Framed > Configure Timeslots > Configure Traffic Bearer > B field > Ext

Ext is also located in the B field menus found in the portable part Configure Traffic Bearer menu and the radio fixed part and portable part Low Capacity menus, and also in the radio fixed part and portable part Configure Custom menus.

EDGE and GSM: Mode > TDMA > *desired format* > Data > Ext

Or: Mode > TDMA > *desired format* > Data Format Pattern Framed > Configure Timeslots > Configure Normal > E > Ext

Ext is also located in the Configure Custom menu and in the E menus found in the Configure Sync menu and the Configure Access menu.

NADC: Mode > TDMA > NADC > Data > Ext

Or: Mode > TDMA > NADC > Data Format Pattern Framed > Configure Timeslots > Configure Up TCH > Data > Ext

Or: Mode > TDMA > NADC > Data Format Pattern Framed > Configure Timeslots > Configure Down TCH > Data > Ext

PDC: **Mode > TDMA > PDC > Data > Ext**

Or: **Mode > TDMA > PDC > Data Format Pattern Framed > Configure Timeslots > Configure Up TCH > TCH > Ext**

Ext is also located in the Configure Up Custom menu, the Configure Down custom menu, and the TCH menu found in the Configure Down TCH menu.

PHS: **Mode > TDMA > PHS > Data > Ext**

Or: **Mode > TDMA > PHS > Data Format Pattern Framed > Configure Timeslots > Configure TCH > TCH > Ext**

Ext is also located in the Data menu found in the uplink Configure TCH menu, and in the downlink and uplink Configure Custom menus.

TETRA: **Mode > TDMA > TETRA > Data > Ext**

Or: **Mode > TDMA > TETRA > Data Format Pattern Framed > Configure Timeslots > Configure Up Normal > Data > Ext**

Ext is also located in the Uplink and Downlink Configure Custom menu and in the Data menus found in every other TETRA Configure Timeslots menu.

In the Pattern Trigger or Frame Trigger Menu In these menu, selecting **Ext** enables you to trigger an event with a signal applied to the TRIGGER IN connector.

Default Value: Single Shot

Softkey Locations

Custom: **Mode > Custom > Pattern Repeat Single > Pattern Trigger > Ext**

NADC and TETRA: **Mode > TDMA > *desired format* > Pattern Repeat Single Cont > Pattern Trigger > Ext**

All Except Custom: **Mode > TDMA > *desired format* > Data Format Pattern Framed > Frame Repeat Single Cont > Frame Trigger > Ext**

Ext Data Clock Normal Symbol

Press this softkey to toggle the external data clock between **Normal** and **Symbol**.

When you select **Normal**, you must supply a signal (either a clock or a pulse) to the DATA CLOCK INPUT connector to clock the DATA and SYMBOL SYNC signals (an unlock occurs if you select external data without these signals).

For 2-bit-per-symbol modulation formats (such as $\pi/4$ DQPSK), when you select **Symbol**, no signal is required at the DATA CLOCK INPUT connector. Instead, the data is clocked on both the rising and falling

edges of the SYMBOL SYNC signal.

Default Value: Normal

Softkey Locations

Custom: **Mode > Custom > Configure Hardware > Ext Data Clock Normal Symbol**

Other Formats: **Mode > TDMA > *desired format* > Configure Hardware > Ext Data Clock Normal Symbol**

Ext Delay Bits

This softkey is inactive until the trigger selection is set to **Ext**. Press this softkey to make the number of bits for the external trigger delay the active function. When **Ext Delay Off On** is on, transmission of the triggered data is delayed after the external trigger event by the number of bits specified.

NOTE

Pattern Repeat and Pattern Trigger functions are *not* available if you use either a PN data sequence or an external data source.

Range: 0 through 65,535 bits

Default Value: 0

Softkey Locations

Custom: **Mode > Custom > Pattern Repeat Single > Pattern Trigger > Ext > Ext Delay Bits**

Other Formats: **Mode > TDMA > *desired format* > Pattern Repeat Single Cont > Pattern Trigger > Ext > Ext Delay Bits**

Ext Delay Off On

This softkey is inactive until the trigger selection is set to **Ext**. Press this softkey to toggle the external trigger delay on and off. When this function is on, the transmission of the triggered data is delayed after the external trigger event by the number of bits specified using the **Ext Delay Bits** softkey.

NOTE

Pattern Repeat and Pattern Trigger functions are *not* available if you use either a PN data sequence or an external data source.

Default Value: Off

Softkey Locations

Custom: **Mode > Custom > Pattern Repeat Single > Pattern Trigger > Ext > Ext Delay Off On**

Other Formats: **Mode > TDMA > *desired format* > Pattern Repeat Single Cont > Pattern Trigger > Ext > Ext Delay Off On**

External 13 MHz Off On

Press this softkey to specify an external 13 MHz reference for the data generator's internal reference clock for EDGE or GSM. Supply the 13 MHz signal to the rear panel BASEBAND GEN RF IN connector. This signal is for the data clock only. The RF signal still requires the internal or external 10 MHz reference.

Default Value: Off

Softkey Location: **Mode > TDMA > *desired format* > Configure Hardware > External 13 MHz Off On**

F

FACC

Press this softkey to select a binary data pattern (frequency accuracy) that consists of a repetitive pattern of 4 ones followed by 4 zeroes. This internally-generated data pattern is available for framed transmissions only. When **FACC** is selected, both the **B field** and the **Dect Patterns** softkeys show this selection, and **FACC** appears in the **B field** located near the bottom of the text area of the display.

Softkey Location: **Mode > TDMA > DECT > Data Format Pattern Framed > Configure Timeslots > Configure Traffic Bearer > B field > Dect Patterns > FACC**

FACC is also located in the **Dect Patterns** menus found in the portable part **Configure Traffic Bearer** menu and the radio fixed part and portable part **Low Capacity** menus, and also in the radio fixed part and portable part **Configure Custom** menus.

Fall Delay

Press this softkey to make the burst shape fall delay the active function.

Range: depends on the modulation type and the symbol rate

Default Values

Custom: 0.000	NADC: -1.000
DECT: -2.875	PDC: -0.500
EDGE: 1.200	PHS: -1.500
GSM: 0.125	TETRA: 0.000

Softkey Locations

Custom: **Mode > Custom > Burst Shape > Fall Delay**

Other Formats: **Mode > TDMA > *desired format* > Modify Standard > Burst Shape > Fall Delay**

Fall Time Press this softkey to make the burst shape fall time the active function.
Range: depends on the modulation type and the symbol rate

Default Values

Custom: 5.470	NADC: 5.470
DECT: 11.529	PDC: 3.830
EDGE: 10.300	PHS: 4.544
GSM: 3.440	TETRA: 7.814

Softkey Locations

Custom: **Mode** > **Custom** > **Burst Shape** > **Fall Time**

Other Formats: **Mode** > **TDMA** > *desired format* > **Modify Standard** > **Burst Shape** > **Fall Time**

FCOR Press this softkey to make the 80-bit frequency correction bits (FCOR) the active function. The preset hexadecimal value reflects the TETRA format, and appears in the FCOR field near the bottom of the text area of the display.

Default Value: FF00000000000000FF

Softkey Location: **Mode** > **TDMA** > **TETRA** > **Data Format Pattern Framed** > **Configure Timeslots** > **Timeslot Type** > **Dn Sync Cont** > **Configure Dn Sync Cont** > **FCOR**

Or: **Mode** > **TDMA** > **TETRA** > **Data Format Pattern Framed** > **Configure Timeslots** > **Timeslot Type** > **Dn Sync Disc** > **Configure Dn Sync Disc** > **FCOR**

FCorr Press this softkey to select frequency correction as the timeslot type for the active timeslot. Frequency correction is a burst where all of the bits are set to zero. This burst is used for synchronizing the mobile to the correct frequency.

When you select **FCorr** for a timeslot, the visual representation of the timeslot pattern updates.

Softkey Location: **Mode** > **TDMA** > **GSM** > **Data Format Pattern Framed** > **Configure Timeslots** > **Timeslot Type** > **FCorr**

FDEV1_FS

Press this softkey to select a binary data pattern (frequency deviation, full-slot) that consists of 128 bits: repetitive pattern of 1, 0, 1, 0... followed by 64 ones, 64 zeroes, and 64 bits: repetitive pattern of 1, 0, 1, 0... This internally-generated data pattern is available for framed transmissions only. When you select **FDEV1_FS**, both the **B field** and the **Dect Patterns** softkeys show this selection, and **FDEV1_FS** appears in the **B field** located near the bottom of the text area of the display.

Softkey Location: **Mode > TDMA > DECT > Data Format Pattern Framed > Configure Timeslots > Configure Traffic Bearer > B field > Dect Patterns > FDEV1_FS**

FDEV1_FS is also located in the Dect Patterns menus found in the portable part Configure Traffic Bearer menu and the radio fixed part and portable part Low Capacity menus, and also in the radio fixed part and portable part Configure Custom menus

FDEV1_HS

Press this softkey to select a binary data pattern (frequency deviation, half-slot) that consists of 8 bits: repetitive pattern of 1, 0, 1, 0... followed by 32 ones, 32 zeroes, and 8 bits: repetitive pattern of 1, 0, 1, 0... This internally-generated data pattern is available for framed transmissions only. When you select **FDEV1_HS**, both the **B field** and the **Dect Patterns** softkeys show this selection, and **FDEV1_HS** appears in the **B field** located near the bottom of the text area of the display.

Softkey Location: **Mode > TDMA > DECT > Data Format Pattern Framed > Configure Timeslots > Configure Traffic Bearer > B field > Dect Patterns > FDEV1_HS**

FDEV1_HS is also located in the Dect Patterns menus found in the portable part Configure Traffic Bearer menu and the radio fixed part and portable part Low Capacity menus, and also in the radio fixed part and portable part Configure Custom menus.

FDEV2_FS

Press this softkey to select a binary data pattern (frequency deviation, full-slot) that consists of a repetitive pattern of 1, 0, 1, 0... This internally-generated data pattern is available for framed transmissions only. When you select **FDEV2_FS**, both the **B field** and the **Dect Patterns** softkeys show this selection, and **FDEV2_FS** appears in the **B field** located near the bottom of the text area of the display.

Softkey Location: **Mode > TDMA > DECT > Data Format Pattern Framed > Configure Timeslots > Configure Traffic Bearer > B field > Dect Patterns > FDEV2_FS**

FDEV2_FS is also located in the Dect Patterns menus found in the portable part Configure Traffic Bearer menu and the radio fixed part and portable part Low Capacity menus, and also in the radio fixed part and portable part Configure Custom menus.

Filter

Press this softkey to access menus where you can:

- Select a filter type
- Restore the default filter
- Define a unique FIR filter
- Adjust filter alpha (for Nyquist or Root Nyquist filters)
- Adjust bandwidth time product (for Gaussian filters)
- Optimize the filter for the best EVM or ACP

Softkey Locations

Custom: **Mode** > **Custom** > **Filter**

Other Formats: **Mode** > **TDMA** > *desired format* > **Modify Standard** > **Filter**

Filter Alpha

Press this softkey to make the FIR filter's alpha parameter in either the Filter menu or the Load Default FIR menu the active function.

In the Filter Menu

In this menu, the Filter Alpha softkey changes the alpha parameter of the selected Root Nyquist or Nyquist filter. To enter a new value, rotate the front-panel knob until the desired value is displayed, use the up and down arrow keys, or enter the value using the numeric keypad and press the Enter terminator softkey.

This key appears only *after* choosing a Root Nyquist or Nyquist filter. If a Gaussian filter is in use, you will see **Filter BbT**. If any other filter is in use, this key is replaced with a grayed-out key labeled **Filter Factor N/A**.

Range: 0.000 through 1.000

Default Values

Custom, NADC, TETRA: 0.350

Other Formats: 0.500

Softkey Locations

Custom: **Mode** > **Custom** > **Filter** > **Select** > **Root Nyquist (or Nyquist)** > **Filter Alpha**

Other Formats: **Mode** > **TDMA** > *desired format* > **Modify Standard** > **Filter** > **Select** > **Root Nyquist (or Nyquist)** > **Filter Alpha**

In the Load Default FIR Menu

In this menu, the Filter Alpha softkey changes the alpha parameter of the Root Nyquist or Nyquist filter coefficients loaded into the FIR table editor. After entering the alpha value, press Generate to modify the filter coefficients in the table editor.

Range: 0.000 through 1.00

Default Value: 0.350

Softkey Locations

Custom: **Mode** > **Custom** > **Filter** > **Define User FIR** > **Load Default FIR** > **Root Nyquist (or Nyquist)** > **Filter Alpha**

Other Formats: **Mode** > **TDMA** > *desired format* > **Modify Standard** > **Filter** > **Define User FIR** > **Load Default FIR** > **Root Nyquist (or Nyquist)** > **Filter Alpha**

Filter BbT

Press this softkey to make the bandwidth-multiplied-by-bit-time (BbT) filter parameter in either the Filter menu or the Load Default FIR menu the active function.

In the Filter Menu

In this menu, the Filter BbT softkey changes the BbT parameter of the selected Gaussian filter.

This key only appears *after* choosing a Gaussian filter. If a Root Nyquist or Nyquist filter is in use, you will see **Filter Alpha**. If any other filter is in use, this key is replaced with a grayed-out key labeled **Filter Factor N/A**.

Range: 0.100 through 1.000

Default Value: 0.300

Softkey Locations

Custom: **Mode** > **Custom** > **Filter** > **Select** > **Gaussian** > **Filter BbT**

GSM and DECT: **Mode** > **TDMA** > *desired format* > **Modify Standard** > **Filter** > **Filter BbT**

Other Formats: **Mode** > **TDMA** > *desired format* > **Modify Standard** > **Filter** > **Select** > **Gaussian** > **Filter BbT**

In the Load Default FIR Menu

In this menu, the Filter BbT softkey changes the BbT parameter of the Gaussian filter coefficients loaded into the FIR table editor. After entering the BbT value, press **Generate** to modify the filter coefficients in the table editor.

Range: 0.100 through 1.000

Default Value: 0.500

Softkey Locations

Custom: **Mode > Custom > Filter > Define User FIR > Load Default FIR > Gaussian > Filter BbT**

Other Formats: **Mode > TDMA > *desired format* > Modify Standard > Filter > Define User FIR > Load Default FIR > Gaussian > Filter BbT**

Filter Factor N/A

This grayed-out softkey is displayed when a filter is in use that does not contain an adjustable alpha or BbT parameter (such as the rectangle filter or a user-defined FIR filter). This softkey changes to either **Filter Alpha** or **Filter BbT** when the appropriate Root Nyquist, Nyquist or Gaussian filter is selected for use.

Softkey Locations

Custom: **Mode > Custom > Filter > Select > Rectangle (or select a User FIR file) > Filter Factor N/A**

Other Formats: **Mode > TDMA > *desired format* > Modify Standard > Filter > Select > Rectangle (or select a User FIR file) > Filter Factor N/A**

Filter Symbols

Press this softkey to select the number of symbols for the filter to be loaded into the FIR table editor. The FIR table editor allows a maximum filter length of 1024 coefficients with a maximum oversample ratio of 32 and a maximum of 32 symbols. If you create a FIR filter with greater than 16 symbols, the maximum symbol rate decreases by half.

Range: 1 through 32

Default Value: 8

Softkey Locations

Custom: **Mode > Custom > Filter > Define User FIR > Load Default FIR > Root Nyquist (or Nyquist or Gaussian or Rectangle) > Filter Symbols**

Other Formats: **Mode > TDMA > *desired format* > Modify Standard > Filter > Define User FIR > Load Default FIR > Root Nyquist (or Nyquist or Gaussian or Rectangle) > Filter Symbols**

FIX4

Press this softkey to select a 4-bit repeating sequence data pattern and make it the active function. Enter the desired 4-bit pattern.

When you select **FIX4** as a data pattern for modulated transmissions that are *not* framed (**Data Format Pattern Framed** is set to **Pattern**), **FIX4** appears in the **Data** field in the top line of the text area of the display.

When you select **FIX4** for configuring the timeslot data fields, the 4-bit pattern is displayed in either the **Data** field (all formats) or the

- **B** field (DECT)
- **E** field (EDGE and GSM)
- **TCH** field (PDC and PHS)

all of which are located near the bottom of the text area of the display.

Range: 0000 through 1111

Default Value: 0000

Softkey Locations

Custom: **Mode > Custom > Data > FIX4**

Other Formats: **Mode > TDMA > *desired format* > Data > FIX4**

DECT: **Mode > TDMA > DECT > Data Format Pattern Framed > Configure Timeslots > Configure Traffic Bearer > B field > FIX4**

FIX4 is also located in the **B** field menus found in the portable part Configure Traffic Bearer menu and the radio fixed part and portable part Low Capacity menus, and also in the radio fixed part and portable part Configure Custom menus.

EDGE: **Mode > TDMA > EDGE (Rev 8.3.0 Release 1999) > Data Format Pattern Framed > Configure Timeslots > Configure Normal > E > FIX4**

Or: **Mode > TDMA > EDGE (Rev 8.3.0 Release 1999) > Data Format Pattern Framed > Configure Timeslots > Timeslot Type > Custom > Configure Custom > Data > FIX4**

GSM: **Mode > TDMA > GSM > Data Format Pattern Framed > Configure Timeslots > Configure Normal > E > FIX4**

FIX4 is also located in the Configure Custom menu, and in the **E** menus found in the Configure Sync and Configure Access menus.

NADC: Mode > TDMA > NADC > Data Format Pattern Framed > Configure Timeslots > Configure Up TCH > Data > FIX4

FIX4 is also located in the Configure Down Custom and Configure Up Custom menus, and in the Data menu found in the Configure Down TCH menu.

PDC: Mode > TDMA > PDC > Data Format Pattern Framed > Configure Timeslots > Configure Up TCH > TCH > FIX4

FIX4 is also located in the Configure Down Custom and Configure Up Custom menus, and in the TCH menu found in the Configure Down TCH menu.

PHS: Mode > TDMA > PHS > Data Format Pattern Framed > Configure Timeslots > Configure TCH > TCH > FIX4

FIX4 is also located in the Data menu found in the uplink Configure TCH menu, and in the downlink and uplink Configure Custom menus.

TETRA: Mode > TDMA > TETRA > Data Format Pattern Framed > Configure Timeslots > Configure Up Normal > Data > FIX4

FIX4 is also located in the uplink and downlink Configure Custom menus, and in the Data menu found in every other TETRA Configure Timeslots menu.

Frame Repeat Single Cont

Press this softkey to toggle between a single output of framed data and continuous transmission of frames. Selecting **Single** outputs the following sequences:

- **4-Bit Patterns (FIX4)** - A single frame is generated. The 4-bit pattern repeats until the data fields are completely filled. Each trigger transmits the same frame.
- **Other Patterns (fixed patterns of equal quantities of ones and zeroes)** - A single frame is generated. The selected pattern repeats until the data fields are completely filled. Each trigger transmits the same frame.
- **PN9** - A single frame is generated. The data fields are filled with the leading bits of the PN9 sequence. A trigger causes the frame to be transmitted. The data fields of this frame are then filled sequentially with the next series of PN9 data bits. A trigger causes the frame to be transmitted. This process continues, transmitting the entire PN9 sequence frame by frame. The last bit of the PN9 sequence in a data field is immediately followed by the first bit of a second PN9 sequence.

- **PN15** - A single frame is generated. The data fields are filled with the leading bits of the PN15 sequence. A trigger causes the frame to be transmitted. The data fields of this frame are then filled sequentially with the next series of PN15 data bits. A trigger causes the frame to be transmitted. This process continues, transmitting the entire PN15 sequence frame by frame. The last bit of the PN15 sequence in a data field is immediately followed by the first bit of a second PN15 sequence.
- **User File** - The user's file should have the appropriate data to fill an integer number of timeslots. If not, the remaining bits are truncated. Depending on the size of the file, more than one frame can possibly be generated.
- **External Data** - External data is clocked into the data fields of the timeslot. A single frame is generated.

Combinations of these data patterns may cause some patterns to be truncated. Refer to "[Digital Modulation Input/Output Relationships](#)" on page 6-9 for the details of the data dependencies.

Selecting **Cont** with framed data causes the frames to be transmitted continuously.

Default Value: Continuous

Softkey Location: **Mode** > **TDMA** > *desired format* > **Data Format Pattern Framed** > **Frame Repeat Single Cont**

Frame Trigger

This key appears in two places:

TDMA Menu

Pressing this softkey displays a menu of softkeys where you can trigger a framed pattern. You can choose to trigger using the front panel **Trigger** key, an external trigger supplied to the PATTERN TRIG IN connector, or by a *TRG command or GET (group execute trigger) signal sent over GPIB. This softkey is inactive for unframed or continuously repeated data. See: "[Data Format Pattern Framed](#)" on page 3-68, and "[Frame Repeat Single Cont](#)" on page 3-97.

Default Value: Trigger Key

Softkey Location: **Mode** > **TDMA** > *desired format* > **Data Format Pattern Framed** > **Frame Repeat Single Cont** > **Frame Trigger**

Edge Menu

This softkey enables the output signal of the EVENT 1 rear panel BNC/SMB connector. The frame trigger signal is one clock pulse at every first cycle of a frame to indicate the beginning of a frame.

Softkey Location: **Mode > TDMA > EDGE (Rev 8.3.0 Release 1999) > BNC MUX Settings > Event 1 > Frame Trigger**

Freq Channels

Pressing this softkey displays a menu of softkeys where you can assign frequency channels and frequency bands based on the current format.

Softkey Location: **Mode > TDMA > *desired format* > Freq Channels**

Freq Channels Off On

Pressing this softkey enables you to set whether the instrument's RF output is determined by the frequency band and frequency channel settings (Freq Channels On), or by the **Frequency** hardkey (Freq Channels Off).

Default Value: Off

Softkey Location: **Mode > TDMA > *desired format* > Freq Channels > Freq Channels Off On**

Freq Dev

This softkey enables you to either select a symmetric FSK frequency deviation, or load a default FSK pattern into the FSK table editor.

Selecting a Symmetric FSK Modulation

Press this softkey to select symmetric FSK frequency deviation and make it the active function.

The selected modulation appears under the **Select** softkey, and the frequency deviation appears under the **FSK** softkey in the Modulation Type menus.

Range

Minimum Value: 0 Hz

Maximum Value: depends upon the symbol rate

Default Values

DECT: 288 kHz
Other Formats: 400.00 Hz

Softkey Locations

Custom: **Mode > Custom > Modulation Type > Select > FSK > Freq Dev**

Other Formats: **Mode > TDMA > *desired format* > Modify Standard > Modulation Type > Select > FSK > Freq Dev**

Loading a Symmetric FSK Pattern into the FSK Table Editor

Press this softkey to define a custom frequency deviation convention in the FSK table editor.

For details on using the FSK table editor, see “[Building a Customized FSK Modulation with the FSK Table Editor](#)” on page 2 -22.

Default Value: 400 Hz

Softkey Locations

Custom: **Mode > Custom > Modulation Type > Define User FSK > Load Default FSK > Freq Dev**

Other Formats: **Mode > TDMA > *desired format* > Modify Standard > Modulation Type > Define User FSK > Load Default FSK > Freq Dev**

FSK

Pressing this softkey accesses a menu of FSK (frequency shift keying) modulation types for modulating a continuous stream of the selected data pattern; you can also change the default frequency deviation.

Softkey Locations

Custom: **Mode > Custom > Modulation Type > Select > FSK**

Other Formats: **Mode > TDMA > *desired format* > Modify Standard > Modulation Type > Select > FSK**

G

G

Press this softkey to change the hexadecimal value for the guard time field. Guard time appears in the visual representation of the timeslot as a 24.75-bit field. In the actual implementation, the guard time field in timeslots 0 and 4 are 27 bits long and the remaining timeslots contain 24-bit fields. Use hexadecimal to enter the value; the signal generator will convert it to binary.

The guard time field is always modulated (but not bursted), even when the timeslot is off. If the guard time and T2 symbols of the current timeslot and the T1 symbols of the next timeslot do not match, the burst shape may not be smooth (even if the current timeslot is turned off).

Range: 0 through 7FFFFFFF for timeslots 0 and 4
0 through 0FFFFFFF for timeslots 1, 2, 3, 5, 6, and 7

Default Value:

Timeslot #	Guard Time Field (Normal & Custom)
0	7FFFFFFF
1	0FFFFFFF
2	0FFFFFFF
3	0FFFFFFF
4	7FFFFFFF
5	0FFFFFFF
6	0FFFFFFF
7	0FFFFFFF

Softkey Location: **Mode > TDMA > EDGE (Rev 8.3.0 Release 1999) > Data Format Pattern Framed > Configure Timeslots > Configure Normal > G**

Or: **Mode > TDMA > EDGE (Rev 8.3.0 Release 1999) > Data Format Pattern Framed > Configure Timeslots > Timeslot Type > Custom > Configure Custom > G**

Gated

Press this softkey to select Gated External Frame Trigger mode.

In Gated External Frame Trigger mode, the pattern waits at last bit until the signal generator receives an inactive-to-active trigger transition, at which time the pattern resets and runs to the end. At end of pattern, if trigger level is still active, then the pattern repeats again. Otherwise, pattern will stop and wait at the last bit until the trigger signal transitions to active. After waiting at the last bit, upon receiving an inactive-to-active trigger transition, the pattern resets and runs.

Softkey Location: **Mode > TDMA > *desired format* > Data Format Pattern Framed > Frame Repeat Single Cont > Frame Trigger > Ext > Gated**

Gated Clock

Use this softkey to select a gated clock signal for the output at the rear panel DATA CLK OUT port. The gated clock has the same clock rate as the bit clock, however it is only active with E-field data.

Softkey Location: **Mode > TDMA > EDGE (Rev 8.3.0Release 1999) > BNC MUX Settings > Data Clk Out > Gated Clock**

Gaussian

Press this softkey to select the Gaussian pre-modulation filter in either the Select (filter) menu or the Load Default FIR menu.

See Also

- “[Display FFT](#)” on page 3 -74
- “[Display Impulse Response](#)” on page 3 -75
- “[Filter BbT](#)” on page 3 -94

In the Select (filter) Menu

In this menu, pressing the Gaussian softkey selects this FIR filter for use in a custom modulation setup.

Softkey Locations

Custom: **Mode > Custom > Filter > Select > Gaussian**

Other Formats: **Mode > TDMA > *desired format* > Modify Standard > Filter > Select > Gaussian**

In the Load Default FIR Menu

In this menu, pressing the **Gaussian** softkey followed by **Generate** loads the FIR table editor with the coefficient values for the filter. The filter BbT and number of filter symbols are defined with the softkeys in this menu. If you change a parameter after loading the filter coefficients, press the **Generate** softkey again to reload the FIR table.

Softkey Locations

Custom: **Mode > Custom > Filter > Define User FIR > Load Default FIR > Gaussian**

Other Formats: **Mode > TDMA > *desired format* > Modify Standard > Filter > Define User FIR > Load Default FIR > Gaussian**

Globally Replace Selected Item

Press this softkey, found in the Define User I/Q menu, to globally replace the selected value throughout the data table. For instance, if you have defined a Q Value of -1, and wish to change it to +1, highlight the -1 value and select Globally Replace Selected Item. All values of -1 (in both the I and the Q column) will be replaced with a value of +1.

Softkey Locations

Custom: **Mode** > **Custom** > **Modulation Type** > **Define User I/Q** > **Globally Replace Selected Item**

Other Formats: **Mode** > **TDMA** > *desired format* > **Modify Standard** > **Modulation Type** > **Define User I/Q** > **Globally Replace Selected Item**

Goto Bottom Row

Press this softkey to move the selection bar to the bottom row in the current table or list of items.

Goto Bottom Row is located in the table editor menus and in the catalogs of files.

Goto Middle Row

Press this softkey to move the selection bar to the middle row in the current table or list of items.

Goto Middle Row is located in the table editor menus and in the catalogs of files.

Goto Row

Press this softkey to display softkeys that enable you to select a row or page in a table or list of items.

Goto Row is located in the table editor menus and in the catalogs of files.

Goto Top Row

Press this softkey to move the selection bar to the top row in the current table or list of items.

Goto Top Row is located in the table editor menus and in the catalogs of files.

Gray Coded QPSK

This softkey appears in two different situations, enabling you to either select a modulation, or load an I/Q map into the I/Q table editor.

Selecting a Gray Coded QPSK Modulation

Press this softkey to select Gray Coded QPSK (quadrature phase shift keying) to modulate a continuous stream of the selected data pattern. Gray Coded QPSK modulation transmits data at the rate of 2 bits per symbol. The constellations for this modulation type are designed so that adjacent symbols differ by only one bit. The modulation selection appears in the `Mod Type` field in the text area of the display, and under the **Select**, **PSK**, and **QPSK and OQPSK** softkeys in the Modulation Type menus.

Softkey Locations

Custom: **Mode** > **Custom** > **Modulation Type** > **Select** > **PSK** > **QPSK and OQPSK** > **Gray Coded QPSK**

Other Formats: **Mode** > **TDMA** > *desired format* > **Modify Standard** > **Modulation Type** > **Select** > **PSK** > **QPSK and OQPSK** > **Gray Coded QPSK**

Loading an I/Q Map

Press this softkey to load a Gray Coded QPSK (quadrature phase shift keying) I/Q map into the I/Q table editor. For details on editing I/Q maps, see “[Mapping Symbol Positions with the I/Q Table Editor](#)” on page 2 -15.

Custom: **Mode** > **Custom** > **Modulation Type** > **Define User I/Q** > **Load Default I/Q Map** > **PSK** > **QPSK and OQPSK** > **Gray Coded QPSK**

Other Formats: **Mode** > **TDMA** > *desired format* > **Modify Standard** > **Modulation Type** > **Define User I/Q** > **Load Default I/Q Map** > **PSK** > **QPSK and OQPSK** > **Gray Coded QPSK**

GSM

Pressing this softkey opens a menu of softkeys where you can generate a pattern formatted in either a framed structure (where the data bits are located in fields defined by the GSM protocol), or a sequence that can be output one or more times.

Softkey Location: **Mode** > **TDMA** > **GSM**

GSM 450 Base

This key selects GSM 450 Base as the frequency band for GSM or EDGE. GSM 450 Base contains channels from 259 to 293.

Softkey Location: **Mode** > **TDMA** > *desired format* > **Freq Channels** > **Channel Band** > **GSM 450/850 Base** > **GSM 450 Base**

GSM 450 Mobile

This key selects GSM 450 Mobile as the frequency band for GSM or EDGE. GSM 450 Mobile contains channels from 259 to 293.

Softkey Location: **Mode** > **TDMA** > *desired format* > **Freq Channels** > **Channel Band** > **GSM 450/850 Base** > **GSM 450 Mobile**

GSM 450/850 Base

This key accesses a menu where you can set the base channel frequency band. The output frequency depends on both the frequency band and channel selections.

Softkey Location: **Mode** > **TDMA** > *desired format* > **Freq Channels** > **Channel Band** > **GSM 450/850 Base**

GSM 450/850 Mobile

This key accesses a menu where you can set the mobile channel frequency band. The output frequency depends on both the frequency band and channel selections.

Softkey Location: **Mode** > **TDMA** > *desired format* > **Freq Channels** > **Channel Band** > **GSM 450/850 Mobile**

GSM 480 Base

This key selects GSM 480 Base as the frequency band for GSM or EDGE. GSM 480 Base contains channels from 306 to 340.

Softkey Location: **Mode** > **TDMA** > *desired format* > **Freq Channels** > **Channel Band** > **GSM 480 Base**

GSM 480 Mobile

This key selects GSM 480 Mobile as the frequency band for GSM or EDGE. GSM 480 Mobile contains channels from 306 to 340.

Softkey Location: **Mode** > **TDMA** > *desired format* > **Freq Channels** > **Channel Band** > **GSM 480 Mobile**

GSM 850 Base

This key selects GSM 850 Base as the frequency band for GSM or EDGE. GSM 850 Base contains channels from 128 to 251.

Softkey Location: **Mode** > **TDMA** > *desired format* > **Freq Channels** > **Channel Band** > **GSM 850 Base**

GSM 850 Mobile

This key selects GSM 850 Mobile as the frequency band for GSM or EDGE. GSM 850 Mobile contains channels from 128 to 251.

Softkey Location: **Mode > TDMA > *desired format* > Freq Channels > Channel Band > GSM 850 Mobile**

GSM Off On

Press this softkey to enable the GSM communications format. Setting **GSM Off On** to **On** sets up the internal hardware to generate a signal that follows the GSM format. The internal I/Q modulator generates GMSK digital modulation and the GSM and I/Q annunciators are turned on in the display. Although the digital modulation is enabled with this softkey, the RF carrier is modulated by the enabled modulation only when you have also set **Mod On/Off** to **On**.

Setting **GSM Off On** to **On** presets the following softkeys in the I/Q menu: **I/Q Off On** is set to **On** and **I/Q Source** is set to **Int I/Q**. You can override these selections in the I/Q menu.

Default Value: Off

Softkey Location: **Mode > TDMA > GSM > GSM Off On**

H

Hamming

Press this softkey to apply the Hamming windowing function to the selected filter. Windowing can be applied to any default FIR filter that you load into the Define User FIR table. Windowing improves out of band performance (ACP), but simultaneously degrades passband performance (EVM), by smoothing the filter's transition to zero. (Hamming is the windowing type applied when you toggle the **Optimize FIR For EVM ACP** softkey to the ACP selection.)

Softkey Location: **Mode** > **TDMA** > *desired format* > **Modify Standard** > **Filter** > **Define User FIR** > **Load Default FIR** > **Root Nyquist** (or any other filter) > **Window** > **Hamming**

Hann

Press this softkey to apply the Hann windowing function to the selected filter. Windowing can be applied to any default FIR filter that you load into the Define User FIR table. Windowing improves out of band performance (ACP), but simultaneously degrades passband performance (EVM), by smoothing the filter's transition to zero.

Softkey Location: **Mode** > **TDMA** > *desired format* > **Modify Standard** > **Filter** > **Define User I/Q** > **Load Default FIR** > **Root Nyquist** (or any other filter) > **Window** > **Hann**

I

IDLE

Press this softkey to make the 34-bit idle message (IDLE) the active function. The preset hexadecimal value (when normal preset is selected) for IDLE reflects the PHS format. The current value for IDLE is displayed in the `IDLE` field near the bottom of the text area of the display.

Default Value: 000000000

Softkey Location: **Mode > TDMA > PHS > Data Format Pattern Framed > Configure Timeslots > Timeslot Type > SYNC > Configure SYNC > IDLE**

Or: **Mode > TDMA > PHS > Data Format Pattern Framed > Configure Timeslots > Control channel Dnlink Uplink > Timeslot Type > SYNC > Configure SYNC > IDLE**

Insert

Press this softkey to display a menu where you can select different methods of inserting bits.

Insert is located in the Bit File Editor menus.

Insert 1's

Press this softkey to insert a user-defined number of 1's at the current cursor position.

Insert 1's is located in the Bit File Editor menus.

Insert 0's

Press this softkey to insert a user-defined number of 0's at the current cursor position.

Insert 0's is located in the Bit File Editor menus.

Insert Row

Press this softkey to insert a new row directly above the highlighted row in the currently active table.

Insert Row is located in the table editor menus.

Interleave Gating

Use this softkey to select a signal with an interleave pattern for the output of the rear panel SYMBOL SYNC OUT port.

Softkey Location: **Mode > TDMA > EDGE (Rev 8.3.0Release 1999) > BNC MUX Settings > Symbol Sync Out > Interleave Gating**

I/Q Scaling

Use this softkey to adjust the amplitude of the I/Q outputs (for better ACP). This adjustment is *not* available if you are using MSK or FSK modulation.

Range: 1 through 10000%

Default Value

Custom: 70%

TETRA: 65%

Other Formats: 100%

Softkey Locations

Custom: **Mode > Custom > Configure Hardware > I/Q Scaling**

Other Formats: **Mode > TDMA > *desired format* > Configure Hardware > I/Q Scaling**

IS-95

This key selects a standard cdmaOne IS-95 filter.

Softkey Locations

Custom: **Mode > Custom > Filter > Select > IS-95 and IS-2000 > IS-95**

Other Formats: **Mode > TDMA > *desired format* > Modify Standard > Filter > Select > IS-95 and IS-2000 > IS-95**

IS-95 and IS-2000

This key accesses a menu of IS-95 and IS-2000 filters.

Softkey Locations

Custom: **Mode > Custom > Filter > Select > IS-95 and IS-2000**

Other Formats: **Mode > TDMA > *desired format* > Modify Standard > Filter > Select > IS-95 and IS-2000**

IS-95 Mod

This key selects a modified version of the standard IS-95 filter. This filter is modified for improved adjacent channel power performance. The modification is done in a manner that meets the IS-95 error function criterion.

Softkey Locations

Custom: **Mode > Custom > Filter > Select > IS-95 and IS-2000 > IS-95 Mod**

Other Formats: **Mode > TDMA > *desired format* > Modify Standard > Filter > Select > IS-95 and IS-2000 > IS-95 Mod**

IS-95 w/EQ

This key selects the standard IS-95 filter with the equalizer for phase compensation required by a base station.

Softkey Locations

Custom: **Mode** > **Custom** > **Filter** > **Select** > **IS-95 and IS-2000** > **IS-95 w/EQ**

Other Formats: **Mode** > **TDMA** > *desired format* > **Modify Standard** > **Filter** > **Select** > **IS-95 and IS-2000** > **IS-95 w/EQ**

IS-95 Mod w/EQ

This key selects a modified version of the standard IS-95 filter. This filter is modified for improved adjacent channel power performance, and includes the equalizer for phase compensation required by a base station. The filter modification is done in a manner that meets the IS-95 error function criterion.

Softkey Locations

Custom: **Mode** > **Custom** > **Filter** > **Select** > **IS-95 and IS-2000** > **IS-95 Mod w/EQ**

Other Formats: **Mode** > **TDMA** > *desired format* > **Modify Standard** > **Filter** > **Select** > **IS-95 and IS-2000** > **IS-95 Mod w/EQ**

IS95 OQPSK

This softkey appears in two different situations, enabling you to either select a modulation, or load an I/Q map into the I/Q table editor.

Selecting an IS95 OQPSK Modulation

Press this softkey to select IS95 OQPSK (offset quadrature phase shift Keying) for modulating a continuous stream of the selected data pattern. IS95 OQPSK modulation transmits data at the rate of 2 bits per symbol. The modulation selection appears in the **Mod Type** field in the text area of the display, and under the **Select**, **QPSK** and **OQPSK**, and **PSK** softkeys in the Modulation Type menus.

Softkey Locations

Custom: **Mode** > **Custom** > **Modulation Type** > **Select** > **PSK** > **QPSK and OQPSK, IS95 OQPSK**

Other Formats: **Mode** > **TDMA** > *desired format* > **Modify Standard** > **Modulation Type** > **Select** > **PSK** > **QPSK and OQPSK** > **IS95 OQPSK**

Loading an OIS95 OQPSK I/Q Map into the Table Editor

Press this softkey to load an IS95 OQPSK (offset quadrature phase shift keying) I/Q map into the I/Q table editor. For details on editing I/Q maps, see “[Mapping Symbol Positions with the I/Q Table Editor](#)” on page 2 -15.

Softkey Locations

Custom: **Mode > Custom > Modulation Type > Define User I/Q > Load Default I/Q Map > PSK > QPSK and OQPSK > IS95 OQPSK**

Other Formats: **Mode > TDMA > *desired format* > Modify Standard > Modulation Type > Define User I/Q > Load Default I/Q Map > PSK > QPSK and OQPSK > IS95 OQPSK**

IS95 QPSK

This softkey appears in two different situations, enabling you to either select a modulation, or load an I/Q map into the I/Q table editor.

Selecting an IS95 QPSK Modulation

Press this softkey to select IS95 QPSK (quadrature phase shift keying) to modulate a continuous stream of the selected data pattern. IS95 QPSK modulation transmits data at the rate of 2 bits per symbol. The modulation selection appears in the **Mod Type** field in the text area of the display, and under the **Select, QPSK and OQPSK, and PSK** softkeys in the Modulation Type menus.

Softkey Locations

Custom: **Mode > Custom > Modulation Type > Select > PSK > QPSK and OQPSK > IS95 QPSK**

Other Formats: **Mode > TDMA > *desired format* > Modify Standard > Modulation Type > Select > PSK > QPSK and OQPSK > IS95 QPSK**

Loading an IS95 OQPSK I/Q Map into the Table Editor

Press this softkey to load an IS95 QPSK (quadrature phase shift keying) I/Q map into the I/Q table editor. For details on editing I/Q maps, see “[Mapping Symbol Positions with the I/Q Table Editor](#)” on page 2 -15.

Softkey Locations

Custom: **Mode > Custom > Modulation Type > Define User I/Q > Load Default I/Q Map > PSK > QPSK and OQPSK > IS95 QPSK**

Other Formats: **Mode > TDMA > *desired format* > Modify Standard > Modulation Type > Define User I/Q > Load Default I/Q Map > PSK > QPSK and OQPSK > IS95 QPSK**

K

Kaiser

Press this softkey to apply the Kaiser windowing function to the selected filter. Windowing can be applied to any default FIR filter that you load into the Define User FIR table. Windowing improves out of band performance (ACP), but simultaneously degrades passband performance (EVM), by smoothing the filter's transition to zero. Selecting **Kaiser** also activates the Beta factor which you can adjust to change the trade-off between optimized ACP or EVM.

Softkey Location: **Mode > TDMA > *desired format* > Modify Standard > Filter > Define User I/Q > Load Default FIR > Root Nyquist (or any other filter) > Window > Kaiser**

L

Load Default FIR

Press this softkey to access a menu for automatically filling the FIR table editor with coefficient values from pre-defined filters such as Root Nyquist, Nyquist, Gaussian and Rectangle. The default filter parameters can also be selected in this menu allowing you to choose the filter alpha or BbT and the number of filter symbols.

Softkey Locations

Custom: **Mode > Custom > Filter > Define User FIR > Load Default FIR**

Other Formats: **Mode > TDMA > *desired format* > Modify Standard > Filter > Define User FIR > Load Default FIR**

Load Default FSK

Press this softkey to select a default symmetric FSK modulation, and configure the frequency deviation for the FSK modulation selected.

Softkey Locations

Custom: **Mode > Custom > Modulation Type > Define User FSK > Load Default FSK**

Other Formats: **Mode > TDMA > *desired format* > Modify Standard > Modulation Type > Define User FSK > Load Default FSK**

Load Default I/Q Map

Press this softkey to select a standard I/Q mapping from a set of either PSK or QAM modulations.

Softkey Locations

Custom: **Mode > Custom > Modulation Type > Define User I/Q > Load Default I/Q Map**

Other Formats: **Mode > TDMA > *desired format* > Modify Standard > Modulation Type > Define User I/Q > Load Default I/Q Map**

Load From Selected File

Press this softkey to replace the current information in a table editor with the information in the highlighted file.

Load From Selected File is located in each of the catalogs of files.

Load Mirror Image of Fall Shape

When editing a burst shape, press this softkey to load the Rise Shape Editor with a mirror image of the Fall Shape Editor.

Note that this softkey is available when the Rise Shape Editor is the active function; when the Fall Shape Editor is the active function, this softkey toggles to [Load Mirror Image of Rise Shape](#).

For information on using this feature, see “[Customizing the Burst Shape](#)” on page 2-7.

Softkey Locations

Custom: **Mode** > **Custom** > **Burst Shape** > **Define User Burst Shape** > **Load Mirror Image of Fall Shape**

Other Formats: **Mode** > **TDMA** > *desired format* > **Modify Standard** > **Burst Shape** > **Define User Burst Shape** > **Load Mirror Image of Fall Shape**

Load Mirror Image of Rise Shape

When editing a burst shape, press this softkey to load the Fall Shape Editor with a mirror image of the Rise Shape Editor.

Note that this softkey is available when the Fall Shape Editor is the active function; when the Rise Shape Editor is the active function, this softkey toggles to [Load Mirror Image of Fall Shape](#).

Softkey Locations

Custom: **Mode** > **Custom** > **Burst Shape** > **Define User Burst Shape** > **Edit Fall Shape** > **Load Mirror Image of Rise Shape**

Other Formats: **Mode** > **TDMA** > *desired format* > **Modify Standard** > **Burst Shape** > **Define User Burst Shape** > **Edit Fall Shape** > **Load Mirror Image of Rise Shape**

Load/Store

Press this softkey to display a menu for loading tables from, and storing tables to, non-volatile memory. Non-volatile memory enables you to retain files for future use after an instrument power cycle.

Load/Store is located in the table editor menus.

Low Capacity

Press this softkey to select low capacity as the timeslot type for the active timeslot; the visual representation of the timeslot type on the display updates to show the configuration.

Softkey Location: **Mode > TDMA > DECT > Data Format Pattern Framed > Configure Timeslots > Timeslot Type > Low Capacity**

Or: **Mode > TDMA > DECT > Data Format Pattern Framed > Configure Timeslots > Transmit Link RFP PP > Timeslot Type > Low Capacity**

Low Capacity with Z Field

Press this softkey to select low capacity with Z field as the timeslot type for the active timeslot; the visual representation of the timeslot type on the display updates to show the configuration.

Softkey Location: **Mode > TDMA > DECT > Data Format Pattern Framed > Configure Timeslots > Timeslot Type > Low Capacity with Z Field**

Or: **Mode > TDMA > DECT > Data Format Pattern Framed > Configure Timeslots > Transmit Link RFP PP > Timeslot Type > Low Capacity with Z Field**

M

Manual Reset & Run

Press this softkey to select Manual Reset & Run External Frame Trigger mode.

In Manual Reset & Run External Frame Trigger mode, the pattern is reset immediately (without running to the end) and restarts and runs repeatedly until next trigger transition to active.

Softkey Location: **Mode > TDMA > *desired format* > Data Format Pattern Framed > Frame Repeat Single Cont > Frame Trigger > Ext > Reset & Run**

Mirror Table

Press this softkey to mirror the FIR table entries such that the table doubles in size and the values in the top half of the table are duplicated in the bottom half of the table in reverse order.

Softkey Locations

Custom: **Mode > Custom > Filter > Define User FIR > Mirror Table**

Other Formats: **Mode > TDMA > *desired format* > Modify Standard > Filter > Define User FIR > Mirror Table**

Mobile

Pressing this softkey selects Standard Mobile as the frequency band for NADC. Standard Mobile contains channels 1 through 799 and 990 through 1023.

Softkey Location: **Mode > TDMA > NADC > Freq Channels > Channel Band > Mobile**

Modify Standard

Pressing this softkey displays a menu of choices that enables you to modify the following aspects of the standard transmission:

- filter characteristics (including user-defined FIR filters)
- symbol rate
- modulation type (including user-defined modulations)
- burst shape characteristics (rising edge time and delay; falling edge time and delay)
- phase polarity

Softkey Location: **Mode > TDMA > *desired format* > Modify Standard**

Modulation Type

Pressing this softkey accesses a menu that enables you to customize the current modulation type. You can define the modulation format, build a symbol mapping, or change the symbol table offset.

Default Values

Custom, PDC, PHS, NADC, and TETRA: $\pi/4$ DQPSK

DECT: 2-Lvl FSK

GSM: MSK

Softkey Locations

Custom: **Mode** > **Custom** > **Modulation Type**

Other Formats: **Mode** > **TDMA** > *desired format* > **Modify Standard** > **Modulation Type**

More

When there are more softkeys in a given menu than can be displayed at one time, **More (1 of 2)** appears as the last softkey. Select this softkey to see the next page of softkeys.

NOTE

To return to the first page of softkeys from the second page, select the **More (2 of 2)** softkey. Do *not* press the **Return** hardkey. **Return** displays the previous *menu*, not the previous page in a menu.

MSK

Press this softkey to select MSK (minimum shift keying) modulation for modulating a continuous stream of the selected data pattern. MSK modulation transmits data at the rate of 1 bit per symbol. When you select MSK, the modulation selection appears in the **Mod Type** field in the text area of the display, and under the **Select** softkey in the **Modulation Type** menu. The phase deviation appears under the **MSK** softkey in the **Modulation Type** menu.

Softkey Locations

Custom: **Mode** > **Custom** > **Modulation Type** > **Select** > **MSK**

Other Formats: **Mode** > **TDMA** > *desired format* > **Modify Standard** > **Modulation Type** > **Select** > **MSK**

Multiframe Channel

Press this softkey to display a menu of softkeys used to configure the data field (E) with a multiframe pseudorandom bit pattern.

Softkey Location: **Mode > TDMA > *desired format* > Data Format Pattern Framed > Configure Timeslots > Configure Normal > E > Multiframe Channel**

Multiframe Data

Use this softkey to select a multiframe data signal output at the rear panel DATA OUT connector.

Softkey Location: **Mode > TDMA > EDGE (Rev 8.3.0Release 1999) > BNC MUX Settings > Data Out > Multiframe Data**

Multiframe Trigger

This softkey specifies that a one clock pulse trigger signal be sent to the rear panel EVENT 1 connector, for every first cycle of a multiframe sequence. This pulse is used to indicate the beginning of the sequence.

Softkey Location: **Mode > TDMA > EDGE (Rev 8.3.0 Release 1999) > BNC MUX Settings > Event 1 > Multiframe Trigger**

N

NADC Pressing this softkey displays a menu of softkeys where you can generate a data pattern formatted into either a framed structure (where the data bits are located in fields defined by the NADC protocol), or a sequence that can be output one or more times.

Softkey Location: **Mode > TDMA > NADC**

NADC Off On Press this softkey to enable the NADC communications format. Setting **NADC Off On** to **On** sets up the internal hardware to generate a signal that follows the NADC format. The internal I/Q modulator generates $\pi/4$ DQPSK digital modulation and the NADC and I/Q annunciators are turned on in the display. Although the digital modulation is enabled with this softkey, the RF carrier is modulated by the enabled modulation only when you have also set **Mod On/Off** to **On**.

Setting **NADC Off On** to **On** presets the following softkeys in the I/Q menu: **I/Q Off On** is set to **On** and **I/Q Source** is set to **Int I/Q**. You can override these selections in the I/Q menu.

Default Value: Off

Softkey Location: **Mode > TDMA > NADC > NADC Off On**

None This softkey appears in two different situations, enabling you to either select a custom modulation or choose a window for the selected filter.

Selecting a Custom Modulation

With **None** selected on the **Predefined Mode** menu, then **Custom** is no longer set up based on a particular format.

Choosing a Window

With **None** selected on the **Window** menu, the filter is optimized for maximum passband performance (EVM).

Softkey Locations

Custom: **Mode > Custom > Predefined Mode > None**

Other Formats: **Mode > TDMA > *desired format* > Modify Standard > Filter > Define User Fir > Load Default FIR > Root Nyquist (or any other filter) > Window > None**

Normal

Press this softkey to select normal as the timeslot type for the active timeslot for both EDGE or GSM.

When you select **Normal** for a timeslot, the visual representation of the timeslot pattern updates.

Softkey Location: **Mode > TDMA > *desired format* > Data Format Pattern Framed > Configure Timeslots > Timeslot Type > Normal**

Normal All

Press this softkey to select normal as the timeslot type for all timeslots. Applies to both EDGE and GSM.

When you select **Normal All**, the visual representation of the timeslot pattern updates.

Softkey Location: **Mode > TDMA > *desired format* > Data Format Pattern Framed > Configure Timeslots > Timeslot Type > Normal All**

Number of Bits

Press this key to specify the number of bits to be inserted or deleted. Press the **Enter** softkey to apply the specified value.

Softkey Locations

Custom: **Mode > Custom > Data > User File > Edit File > Delete > Number of Bits**

Other Formats: **Mode > TDMA > *desired format* > Data > User File > Edit File > Delete > Number of Bits**

Nyquist

Press this softkey to select the Nyquist (raised cosine) pre-modulation filter in either the Select (filter) menu or the Load Default FIR menu.

See Also

- “[Display FFT](#)” on page 3 -74
- “[Display Impulse Response](#)” on page 3 -75
- “[Filter Alpha](#)” on page 3 -93

In the Select (filter) Menu

In this menu, pressing the **Nyquist** softkey selects this FIR filter for use in a custom modulation setup.

Softkey Locations

Custom: **Mode > Custom > Filter > Select > Nyquist**

Other Formats: **Mode > TDMA > *desired format* > Modify Standard > Filter > Select > Nyquist**

In the Load Default FIR Menu

In this menu, pressing the **Nyquist** softkey followed by **Generate** loads the FIR table editor with the coefficient values for the filter. The filter alpha and number of filter symbols are defined with the softkeys in this menu. If you change a parameter after loading the filter coefficients, press the **Generate** softkey again to reload the FIR table.

Softkey Locations

Custom: **Mode > Custom > Filter > Define User FIR > Load Default FIR > Nyquist**

Other Formats: **Mode > TDMA > *desired format* > Modify Standard > Filter > Define User FIR > Load Default FIR > Nyquist**

0

Offset Q Off On

Press this softkey to change the operational state of the user I/Q offset Q, which defines whether the Q output is delayed by 1/2 symbol from the I output.

Default Value: Off

Softkey Locations

Custom: **Mode** > **Custom** > **Modulation Type** > **Define User IQ** > **Offset Q Off On**

Other Formats: **Mode** > **TDMA** > *desired format* > **Modify Standard** > **Modulation Type** > **Define User IQ** > **Offset Q Off On**

Optimize FIR For EVM ACP

Press this softkey to optimize the filter for minimized error vector magnitude (select EVM) or for minimized adjacent channel power (select ACP). The EVM selection provides the most ideal passband. The ACP selection improves stopband rejection. This feature applies only to Root Nyquist, and Nyquist filters; the softkey is grayed out when any other filter is selected.

Default Values

Custom: ACP

Other Formats: EVM

Softkey Locations

Custom: **Mode** > **Custom** > **Filter** > **Optimize FIR For EVM ACP**

EDGE, GSM and DECT: **Mode** > **TDMA** > *desired format* > **Modify Standard** > **Filter** > **Select** > **Root Nyquist (or Nyquist)** > **Optimize FIR For EVM ACP**

NADC, PDC, PHS, and TETRA: **Mode** > **TDMA** > *desired format* > **Modify Standard** > **Filter** > **Optimize FIR For EVM ACP**

OQPSK

This softkey appears in two different situations, enabling you to either select a modulation, or load an I/Q map into the I/Q table editor.

Selecting an OQPSK Modulation

Press this softkey to select OQPSK (offset quadrature phase shift keying) for modulating a continuous stream of the selected data pattern. OQPSK modulation transmits data at the rate of 2 bits per symbol. The modulation selection appears in the `Mod Type` field in the text area of the display, and under the **Select, QPSK and OQPSK**, and **PSK** softkeys in the Modulation Type menus.

Softkey Locations

Custom: **Mode > Custom > Modulation Type > Select > PSK > QPSK and OQPSK > OQPSK**

Other Formats: **Mode > TDMA > *desired format* > Modify Standard > Modulation Type > Select > PSK > QPSK and OQPSK > OQPSK**

Loading an OQPSK I/Q Map into the I/Q Table Editor

Press this softkey to load a OQPSK (offset quadrature phase shift keying) I/Q map into the I/Q table editor. For details on editing I/Q maps, see “[Mapping Symbol Positions with the I/Q Table Editor](#)” on page 2 -15.

Softkey Locations

Custom: **Mode > Custom > Modulation Type > Define User I/Q > Load Default I/Q Map > PSK > QPSK and OQPSK > OQPSK**

Other Formats: **Mode > TDMA > *desired format* > Modify Standard > Modulation Type > Define User I/Q > Load Default I/Q Map > PSK > QPSK and OQPSK > OQPSK**

Other Patterns

Pressing this softkey displays a menu of data pattern selections; each is a pattern of equal quantities of ones and zeroes. The selected pattern appears in the **Other Patterns** softkey and in the **Data** softkey.

Softkey Locations

Custom: **Mode > Custom > Data > Other Patterns**

Other Formats: **Mode > TDMA > *desired format* > Data > Other Patterns**

DECT: **Mode > TDMA > DECT > Data Format Pattern Framed > Configure Timeslots > Configure Traffic Bearer > B field > Other Patterns**

Other Patterns is also located in the B field menus found in the portable part Configure Traffic Bearer menu and the radio fixed part and portable part Low Capacity menus, and also in the radio fixed part and portable part Configure Custom menus.

EDGE and GSM: **Mode > TDMA > *desired format* > Data Format Pattern Framed > Configure Timeslots > Configure Normal > E > Other Patterns**

Other Patterns is also located in the Configure Custom menu, and in the E menus found in the Configure Sync and Configure Access menus.

NADC: **Mode > TDMA > NADC > Data Format Pattern Framed > Configure Timeslots > Configure UP TCH > Data > Other Patterns**

Other Patterns is also located in the Configure Down Custom and Configure Up Custom menus, and in the Data menu found in the Configure Down TCH menu.

PDC: **Mode > TDMA > PDC > Data Format Pattern Framed > Configure Timeslots > Configure Up TCH > TCH > Other Patterns**

Other Patterns is also located in the Configure Down Custom and Configure Up Custom menus, and in the TCH menu found in the Configure Down TCH menu.

PHS: **Mode > TDMA > PHS > Data Format Pattern Framed > Configure Timeslots > Configure TCH > TCH > Other Patterns**

Other Patterns is also located in the Data menu found in the uplink Configure TCH menu, and in the downlink and uplink Configure Custom menus.

TETRA: **Mode > TDMA > TETRA > Data Format Pattern Framed > Configure Timeslots > Configure Up Normal > Data > Other Patterns**

Other Patterns is also located in the uplink and downlink Configure Custom menus, and in the Data menus found in every other TETRA Configure Timeslots menu.

Oversample Ratio

Press this softkey to specify the oversample ratio for a user-defined FIR filter.

Range

Acceptable values range from 1 to 32. When the filter is selected for use, the signal generator may resample the filter with an OSR between 4 and 16, based on the number of symbols, the symbol rate, and the number of bits per symbol of the modulation type.

Generally, the higher the symbol rate, the lower the oversample ratio of the resampled filter. The following table describes the signal generator's maximum oversample ratio capabilities for each modulation type:

Modulation Type	BPS	Maximum OSR	
		≤ 16 Symbols	> 16 Symbols
BPSK MSK 2-LVL FSK	1	16	8
QPSK IS95 QPSK ISAT QPSK OQPSK IS95 OQPSK	2	16	8
8PSK D8PSK 8-LVL FSK	3	15	6
16PSK 16QAM	4	16	8
32QAM	5	15	5
64QAM	6	15	6
256QAM	8	16	8

Default Value: 4

Softkey Locations

Custom: **Mode > Custom > Filter > Define User FIR > Oversample Ratio**

Other Formats: **Mode > TDMA > *desired format* > Modify Standard > Filter > Define User FIR > Oversample Ratio**

P

Page Down Pressing this softkey displays the next page of entries. **Page Down** is located in the table editor menus and in the catalogs of files.

Page Up Pressing this softkey displays the previous page of entries. **Page Up** is located in the table editor menus and in the catalogs of files.

Pattern Repeat Single Cont

Press this softkey to toggle the data pattern repeat from single to continuous. Notice that your selection appears after `Repeat` in the text display. After preset, the instrument default is continuous. Toggling pattern repeat to single, enables the **Pattern Trigger** softkey.

NOTE Pattern Repeat and Pattern Trigger functions are *not* available if you use either a PN data sequence, or an external data source.

Default Value: Continuous

Softkey Locations

Custom: **Mode** > **Custom** > **Pattern Repeat Single Cont**

Other Formats: **Mode** > **TDMA** > *desired format* > **Pattern Repeat Single Cont**

Pattern Trigger

Press this softkey to display a menu of keys for triggering an unframed modulated data pattern. The selection (Trigger Key, Bus, or Ext) appears under the **Pattern Trigger** softkey.

Pattern triggering is active only when the [Pattern Repeat Single Cont](#) softkey is set to single.

NOTE Pattern Repeat and Pattern Trigger functions are *not* available if you use either a PN data sequence, or an external data source.

Default Value: Trigger key

Softkey Locations

Custom: **Mode** > **Custom** > **Pattern Repeat Single** > **Pattern Trigger**

Other Formats: **Mode** > **TDMA** > *desired format* > **Pattern Repeat Single Cont** > **Pattern Trigger**

- PCS Base** Pressing this softkey selects PCS 1900 Base as the channel band for EDGE or GSM. PCS 1900 Base contains channels 512 through 810.
Softkey Location: **Mode** > **TDMA** > *desired format* > **Freq Channels** > **Channel Band** > **PCS Base**
- PCS Mobile** Pressing this softkey selects PCS 1900 Mobile as the channel band for GSM or EDGE. PCS 1900 Mobile contains channels 512 through 810.
Softkey Location: **Mode** > **TDMA** > *desired format* > **Freq Channels** > **Channel Band** > **PCS Mobile**
- PDC** Pressing this softkey displays a menu of softkeys where you can generate a data pattern formatted into either a framed structure (where the data bits are located in fields defined by the PDC protocol) or a sequence that can be output one or more times.
Softkey Location: **Mode** > **TDMA** > **PDC**
- PDC Off On** Press this softkey to enable the PDC communications format. Setting **PDC Off On** to **On** sets up the internal hardware to generate a signal that follows the PDC format. The internal I/Q modulator generates $\pi/4$ DQPSK digital modulation and the PDC and I/Q annunciators are turned on in the display. Although the digital modulation is enabled with this softkey, the RF carrier is modulated by the enabled modulation only when you have also set **Mod On/Off** to **On**.
Setting **PDC Off On** to **On** presets the following softkeys in the I/Q menu: **I/Q Off On** is set to **On** and **I/Q Source** is set to **Int I/Q**. You can override these selections in the I/Q menu.
Default Value: Off
Softkey Location: **Mode** > **TDMA** > **PDC** > **PDC Off On**
- P-GSM Base** Pressing this softkey selects P-GSM 900 Base as the channel band for EDGE or GSM. P-GSM 900 Base contains channels 1 through 124.
Softkey Location: **Mode** > **TDMA** > *desired format* > **Freq Channels** > **Channel Band** > **P-GSM Base**
- P-GSM Mobile**
Pressing this softkey selects P-GSM 900 Mobile as the channel band for EDGE or GSM. P-GSM 900 Mobile contains channels 1 through 124.
Softkey Location: **Mode** > **TDMA** > *desired format* > **Freq Channels** > **Channel Band** > **P-GSM Mobile**

PHS

Pressing this softkey displays a menu of softkeys where you can generate a data pattern formatted into either a framed structure (where the data bits are located in fields defined by the PHS protocol) or a sequence that can be output one or more times.

Softkey Location: **Mode > TDMA > PHS**

PHS Off On

Press this softkey to enable the PHS communications format. Setting **PHS Off On** to **On** sets up the internal hardware to generate the structure that follows the PHS format. The internal I/Q modulator generates $\pi/4$ DQPSK digital modulation and the PHS and I/Q annunciators are turned on in the display. Although the digital modulation is enabled with this softkey, the RF carrier is modulated by the enabled modulation only when you have also set **Mod On/Off** to **On**.

Setting **PHS Off On** to **On** presets the following softkeys in the I/Q menu: **I/Q Off On** is set to **On** and **I/Q Source** is set to **Int I/Q**. You can override these selections in the I/Q menu.

Default Value: Off

Softkey Location: **Mode > TDMA > PHS > PHS Off On**

Phase Dev

Press this softkey to make the MSK (minimum shift keying) phase deviation the active function. The current value appears under the **MSK** softkey in the Modulation Type menu.

Range: 0° to 100°

Default Value: 90.00 deg

Softkey Locations

Custom: **Mode > Custom > Modulation Type > Select > MSK > Phase Dev**

Other Formats: **Mode > TDMA > *desired format* > Modify Standard > Modulation Type > Select > MSK > Phase Dev**

Phase Polarity Normal Invert

Press this softkey to reverse the direction of rotation of the phase modulation vector. When you choose **Invert**, the in-phase component lags the quadrature-phase component by 90° in the resulting modulation. The inverted selection also applies to the I OUT and Q OUT signals.

Default Value: Normal

Softkey Locations

Custom: **Mode > Custom > Phase Polarity Normal Invert**

Other Formats: **Mode > TDMA > *desired format* > Modify Standard > Phase Polarity Normal Invert**

PN9

Press this softkey to select an internally-generated PN9 pseudorandom bit pattern.

For unframed transmissions, PN9 appears in the Data field in the top line of the text area of the display.

For framed timeslot data fields, PN9 appears in the Data field or the B field, both of which are located near the bottom of the text area of the display.

For configuring the timeslot data fields, PN9 appears in either the Data field (all formats) or the

- B field (DECT)
- E field (EDGE and GSM)
- TCH field (PDC and PHS)

Softkey Locations

Custom: **Mode > Custom > Data > PN Sequence > PN9**

Other Formats: **Mode > TDMA > *desired format* > Data > PN Sequence > PN9**

DECT: **Mode > TDMA > DECT > Data Format Pattern Framed > Configure Timeslots > Configure Traffic Bearer > B field > PN Sequence > PN9**

PN9 is also located in the B field menus found in the portable part Configure Traffic Bearer menu and the radio fixed part and portable part Low Capacity menus, and also in the radio fixed part and portable part Configure Custom menus.

EDGE and GSM: **Mode > TDMA > *desired format* > Data Format Pattern Framed > Configure Timeslots > Configure Normal > E > PN9**

PN9 is also located in the Configure Custom menu, and in the E menus found in the Configure Sync and Configure Access menus.

NADC: **Mode > TDMA > NADC > Data Format Pattern Framed > Configure Timeslots > Configure UP TCH > Data > PN Sequence > PN9**

PN9 is also located in the Configure Down Custom and Configure Up Custom menus, and in the Data menu found in the Configure Down TCH menu.

PDC: **Mode > TDMA > PDC > Data Format Pattern Framed > Configure Timeslots > Configure Up TCH > TCH > PN Sequence > PN9**

PN9 is also located in the Configure Down Custom and Configure Up Custom menus, and in the TCH menu found in the Configure Down TCH menu.

PHS: Mode > TDMA > PHS > Data Format Pattern Framed > Configure Timeslots > Configure TCH > TCH > PN Sequence > PN9

PN9 is also located in the Data menu found in the uplink Configure TCH menu, and in the downlink and uplink Configure Custom menus.

TETRA: Mode > TDMA > TETRA > Data Format Pattern Framed > Configure Timeslots > Configure Up Normal > Data > PN Sequence > PN9

PN9 is also located in the uplink and downlink Configure Custom menus, and in the Data menus found in every other TETRA Configure Timeslots menu.

PN11

Press this softkey to select an internally-generated PN11 pseudorandom bit pattern.

For unframed transmissions, PN11 appears in the Data field in the top line of the text area of the display.

For framed timeslot data fields, PN11 appears in the Data field or the B field, both of which are located near the bottom of the text area of the display.

For configuring the timeslot data fields, PN11 appears in either the Data field (all formats) or the

- B field (DECT)
- E field (GSM)
- TCH field (PDC and PHS)

Softkey Locations

Custom: Mode > Custom > Data > PN Sequence > PN11

Other Formats: Mode > TDMA > *desired format* > Data > PN Sequence > PN11

DECT: Mode > TDMA > DECT > Data Format Pattern Framed > Configure Timeslots > Configure Traffic Bearer > B field > PN Sequence > PN11

PN11 is also located in the B field menus found in the portable part Configure Traffic Bearer menu and the radio fixed part and portable part Low Capacity menus, and also in the radio fixed part and portable part Configure Custom menus.

GSM: Mode > TDMA > GSM > Data Format Pattern Framed > Configure Timeslots > Configure Normal > E > PN Sequence > PN11

PN11 is also located in the Configure Custom menu, and in the E menus found in the Configure Sync and Configure Access menus.

**NADC: Mode > TDMA > NADC > Data Format Pattern Framed >
Configure Timeslots > Configure Up TCH > Data > PN Sequence > PN11**

PN11 is also located in the Configure Down Custom and Configure Up Custom menus, and in the Data menu found in the Configure Down TCH menu.

**PDC: Mode > TDMA > PDC > Data Format Pattern Framed >
Configure Timeslots > Configure Up TCH > TCH > PN Sequence > PN11**

PN11 is also located in the Configure Down Custom and Configure Up Custom menus, and in the TCH menu found in the Configure Down TCH menu.

**PHS: Mode > TDMA > PHS > Data Format Pattern Framed >
Configure Timeslots > Configure TCH > TCH > PN Sequence > PN11**

PN11 is also located in the Data menu found in the uplink Configure TCH menu, and in the downlink and uplink Configure Custom menus.

**TETRA: Mode > TDMA > TETRA > Data Format Pattern Framed >
Configure Timeslots > Configure Up Normal > Data > PN Sequence > PN11**

PN11 is also located in the uplink and downlink Configure Custom menus, and in the Data menus found in every other TETRA Configure Timeslots menu.

PN15

Press this softkey to select an internally-generated PN15 pseudorandom bit pattern.

For unframed transmissions, PN15 appears in the Data field in the top line of the text area of the display.

For framed timeslot data fields, PN15 appears in the Data field or the B field, both of which are located near the bottom of the text area of the display.

For configuring the timeslot data fields, PN15 appears in either the Data field (all formats) or the

- B field (DECT)
- E field (EDGE and GSM)
- TCH field (PDC and PHS)

Softkey Locations

Custom: **Mode > Custom > Data > PN Sequence > PN15**

Other Formats: **Mode > TDMA > *desired format* > Data > PN Sequence > PN15**

DECT: **Mode > TDMA > DECT > Data Format Pattern Framed > Configure Timeslots > Configure Traffic Bearer > B field > PN Sequence > PN15**

PN15 is also located in the B field menus found in the portable part Configure Traffic Bearer menu and the radio fixed part and portable part Low Capacity menus, and also in the radio fixed part and portable part Configure Custom menus.

EDGE and GSM: **Mode > TDMA > *desired format* > Data Format Pattern Framed > Configure Timeslots > Configure Up Normal > E > PN Sequence > PN15**

PN15 is also located in the Configure Custom menu, and in the E menus found in the Configure Sync and Configure Access menus.

NADC: **Mode > TDMA > NADC > Data Format Pattern Framed > Configure Timeslots > Configure TCH > Data > PN Sequence > PN15**

PN15 is also located in the Configure Down Custom and Configure Up Custom menus, and in the Data menu found in the Configure Down TCH menu.

PDC: **Mode > TDMA > PDC > Data Format Pattern Framed > Configure Timeslots > Configure Up TCH > TCH > PN Sequence > PN15**

PN15 is also located in the Configure Down Custom and Configure Up Custom menus, and in the TCH menu found in the Configure Down TCH menu.

PHS: **Mode > TDMA > PHS > Data Format Pattern Framed > Configure Timeslots > Configure TCH > TCH > PN Sequence > PN15**

PN15 is also located in the Data menu found in the uplink Configure TCH menu, and in the downlink and uplink Configure Custom menus.

TETRA: **Mode > TDMA > TETRA > Data Format Pattern Framed > Configure Timeslots > Configure Up Normal > Data > PN Sequence > PN15**

PN15 is also located in the uplink and downlink Configure Custom menus, and in the Data menus found in every other TETRA Configure Timeslots menu.

PN20

Press this softkey to select an internally-generated PN20 pseudorandom bit pattern.

For unframed transmissions, PN20 appears in the Data field in the top line of the text area of the display.

For framed timeslot data fields, PN20 appears in the Data field or the B field, both of which are located near the bottom of the text area of the display.

For configuring the timeslot data fields, PN20 appears in either the Data field (all formats) or the

- B field (DECT)
- E field (EDGE and GSM)
- TCH field (PDC and PHS)

Softkey Locations

Custom: Mode > Custom > Data > PN Sequence > PN20

Other Formats: Mode > TDMA > *desired format* > Data > PN Sequence > PN20

DECT: Mode > TDMA > DECT > Data Format Pattern Framed > Configure Timeslots > Configure Traffic Bearer > B field > PN Sequence > PN20

PN20 is also located in the B field menus found in the portable part Configure Traffic Bearer menu and the radio fixed part and portable part Low Capacity menus, and also in the radio fixed part and portable part Configure Custom menus.

GSM: Mode > TDMA > GSM > Data Format Pattern Framed > Configure Timeslots > Configure Up Normal > E > PN Sequence > PN20

PN20 is also located in the Configure Custom menu, and in the E menus found in the Configure Sync and Configure Access menus.

NADC: Mode > TDMA > NADC > Data Format Pattern Framed > Configure Timeslots > Configure Up TCH > Data > PN Sequence > PN20

PN20 is also located in the Configure Down Custom and Configure Up Custom menus, and in the Data menu found in the Configure Down TCH menu.

PDC: Mode > TDMA > PDC > Data Format Pattern Framed > Configure Timeslots > Configure Up TCH > TCH > PN Sequence > PN20

PN20 is also located in the Configure Down Custom and Configure Up Custom menus, and in the TCH menu found in the Configure Down TCH menu.

PHS: Mode > TDMA > PHS > Data Format Pattern Framed > Configure Timeslots > Configure TCH > TCH > PN Sequence > PN20

PN20 is also located in the Data menu found in the uplink Configure TCH menu, and in the downlink and uplink Configure Custom menus.

TETRA: Mode > TDMA > TETRA > Data Format Pattern Framed > Configure Timeslots > Configure Up Normal > Data > PN Sequence > PN20

PN20 is also located in the uplink and downlink Configure Custom menus, and in the Data menus found in every other TETRA Configure Timeslots menu.

PN23

Press this softkey to select an internally-generated PN23 pseudorandom bit pattern.

For unframed transmissions, PN23 appears in the Data field in the top line of the text area of the display.

For framed timeslot data fields, PN23 appears in the Data field or the B field, both of which are located near the bottom of the text area of the display.

For configuring the timeslot data fields, PN23 appears in either the Data field (all formats) or the

- B field (DECT)
- E field (EDGE and GSM)
- TCH field (PDC and PHS)

Softkey Locations

Custom: Mode > Custom > Data > PN Sequence > PN23

Other Formats: Mode > TDMA > *desired format* > Data > PN Sequence > PN23

DECT: Mode > TDMA > DECT > Data Format Pattern Framed > Configure Timeslots > Configure Traffic Bearer > B field > PN Sequence > PN23

PN23 is also located in the B field menus found in the portable part Configure Traffic Bearer menu and the radio fixed part and portable part Low Capacity menus, and also in the radio fixed part and portable part Configure Custom menus.

GSM: Mode > TDMA > GSM > Data Format Pattern Framed > Configure Timeslots > Configure Up Normal > E > PN Sequence > PN23

PN23 is also located in the Configure Custom menu, and in the E menus found in the Configure Sync and Configure Access menus.

NADC: Mode > TDMA > NADC > Data Format Pattern Framed > Configure Timeslots > Configure Up TCH > Data > PN Sequence > PN23

PN23 is also located in the Configure Down Custom and Configure Up Custom menus, and in the Data menu found in the Configure Down TCH menu.

PDC: Mode > TDMA > PDC > Data Format Pattern Framed > Configure Timeslots > Configure Up TCH > TCH > PN Sequence > PN23

PN23 is also located in the Configure Down Custom and Configure Up Custom menus, and in the TCH menu found in the Configure Down TCH menu.

PHS: Mode > TDMA > PHS > Data Format Pattern Framed > Configure Timeslots > Configure TCH > TCH > PN Sequence > PN23

PN23 is also located in the Data menu found in the uplink Configure TCH menu, and in the downlink and uplink Configure Custom menus.

TETRA: Mode > TDMA > TETRA > Data Format Pattern Framed > Configure Timeslots > Configure Up Normal > Data > PN Sequence > PN23

PN23 is also located in the uplink and downlink Configure Custom menus, and in the Data menus found in every other TETRA Configure Timeslots menu.

PN Sequence Press this softkey to display a menu of choices for pseudorandom internal data generation.

Default Values

EDGE: PN9

Other Formats: PN23

Softkey Locations

Custom: **Mode > Custom > Data > PN Sequence**

Other Formats: **Mode > TDMA > *desired format* > Data > PN Sequence**

DECT: **Mode > TDMA > DECT > Data Format Pattern Framed > Configure Timeslots > Configure Traffic Bearer > B field > PN Sequence**

PN Sequence is also located in the B field menus found in the portable part Configure Traffic Bearer menu and the radio fixed part and portable part Low Capacity menus, and also in the radio fixed part and portable part Configure Custom menus.

EDGE and GSM: **Mode > TDMA > *desired format* > Data Format Pattern Framed > Configure Timeslots > Configure Normal > E > PN Sequence**

PN Sequence is also located in the Configure Custom menu, and in the E menus found in the Configure Sync and Configure Access menus.

NADC: Mode > TDMA > NADC > Data Format Pattern Framed > Configure Timeslots > Configure TCH > Data > PN Sequence

PN Sequence is also located in the Configure Down Custom and Configure Up Custom menus, and in the Data menu found in the Configure Down TCH menu.

PDC: Mode > TDMA > PDC > Data Format Pattern Framed > Configure Timeslots > Configure Up TCH > TCH > PN Sequence

PN Sequence is also located in the Configure Down Custom and Configure Up Custom menus, and in the TCH menu found in the Configure Down TCH menu.

PHS: Mode > TDMA > PHS > Data Format Pattern Framed > Configure Timeslots > Configure TCH > TCH > PN Sequence

PN Sequence is also located in the Data menu found in the uplink Configure TCH menu, and in the downlink and uplink Configure Custom menus.

TETRA: Mode > TDMA > TETRA > Data Format Pattern Framed > Configure Timeslots > Configure Up Normal > Data > PN Sequence

PN Sequence is also located in the Data menus found in every other TETRA Configure Timeslots menu.

Predefined Mode

Press this softkey to set up Custom with the appropriate defaults for the format specified. Custom then detects if the parameters are varied and displays **Modified** next to the format title on the status display if they differ. Selecting **None** removes this check and clears the status specification of the format.

Softkey Location: **Mode > Custom > Predefined Mode**

PSID

Press this softkey to make the 28-bit personal station identification code (PSID) the active value. The preset hexadecimal value (when normal preset is selected) for PSID reflects the PHS format. The current value for PSID is displayed in the **PSID** field near the bottom of the text area of the display.

Default Value: 0000001

Softkey Location: **Mode > TDMA > PHS > Data Format Pattern Framed > Configure Timeslots > Timeslot Type > SYNC > Configure SYNC > PSID**

PSK

This softkey appears in two different situations, enabling you to either select a modulation, or load an I/Q map into the I/Q table editor.

Selecting a PSK Modulation

Pressing this softkey displays a menu of PSK (phase shift keying) modulation types to modulate a continuous stream of the selected data pattern. You can choose from QPSK and OQPSK, BPSK, $\pi/4$ DQPSK, 8PSK, 16PSK, D8PSK and EDGE. (EDGE is only available in the EDGE format.)

Softkey Locations

Custom: **Mode** > **Custom** > **Modulation Type** > **Select** > **PSK**

Other Formats: **Mode** > **TDMA** > *desired format* > **Modify Standard** > **Modulation Type** > **Select** > **PSK**

Loading a PSK I/Q Map into the I/Q Table Editor

Pressing this softkey displays a menu of PSK (phase shift keying) modulation types that you can load into the I/Q table editor. For details on editing I/Q maps, see “[Mapping Symbol Positions with the I/Q Table Editor](#)” on page 2 -15.

Softkey Locations

Custom: **Mode** > **Custom** > **Modulation Type** > **Define User I/Q** > **Load Default I/Q Map** > **PSK**

Other Formats: **Mode** > **TDMA** > *desired format* > **Modify Standard** > **Modulation Type** > **Define User I/Q** > **Load Default I/Q Map** > **PSK**

Q

QAM

This softkey appears in two different situations, enabling you to either select a modulation, or load a default I/Q map into the I/Q table editor.

Selecting a QAM Modulation

Pressing this softkey displays a menu of QAM (quadrature amplitude modulation) modulation types to modulate a continuous stream of the selected data pattern. You can choose from 4QAM, 16QAM, 32QAM, 64QAM, and 256QAM.

Softkey Locations

Custom: **Mode > Custom > Modulation Type > Select > QAM**

Other Formats: **Mode > TDMA > *desired format* > Modify Standard > Modulation Type > Select > QAM**

Loading a QAM I/Q Map into the I/Q Table Editor

Pressing this softkey displays a menu of QAM (quadrature amplitude modulation) modulation types that you can load into the I/Q table editor. For details on editing I/Q maps, see “[Mapping Symbol Positions with the I/Q Table Editor](#)” on page 2 -15.

Softkey Locations

Custom: **Mode > Custom > Modulation Type > Define User I/Q > Load Default I/Q Map > QAM**

Other Formats: **Mode > TDMA > *desired format* > Modify Standard > Modulation Type > Define User I/Q > Load Default I/Q Map > QAM**

QPSK

This softkey appears in two different situations, enabling you to either select a modulation, or load a default I/Q map into the I/Q table editor (see [“Loading a QPSK I/Q Map into the I/Q Table Editor,”](#) on the next page).

Selecting a QPSK Modulation

Press this softkey to select QPSK (quadrature phase shift keying) to modulate a continuous stream of the selected data pattern. QPSK modulation transmits data at the rate of 2 bits per symbol. The modulation selection appears in the `Mod Type` field in the text area of the display, and under the **Select, QPSK and OQPSK, and PSK** softkeys in the Modulation Type menus.

Softkey Locations

Custom: **Mode > Custom > Modulation Type > Select > PSK > QPSK and OQPSK > QPSK**

Other Formats: **Mode > TDMA > *desired format* > Modify Standard > Modulation Type > Select > PSK > QPSK and OQPSK > QPSK**

Loading a QPSK I/Q Map into the I/Q Table Editor

Press this softkey to load a QPSK (quadrature phase shift keying) I/Q map into the I/Q table editor. For details on editing I/Q maps, see [“Mapping Symbol Positions with the I/Q Table Editor”](#) on page 2 -15.

Softkey Locations

Custom: **Mode > Custom > Modulation Type > Define User I/Q > Load Default I/Q Map > PSK > QPSK and OQPSK > QPSK**

Other Formats: **Mode > TDMA > *desired format* > Modify Standard > Modulation Type > Define User I/Q > Load Default I/Q Map > PSK > QPSK and OQPSK > QPSK**

QPSK and OQPSK

This softkey appears in two different situations, enabling you to either select a modulation, or load a default I/Q map into the I/Q table editor.

Selecting a QPSK and OQPSK Modulation

Pressing this softkey displays a menu of QPSK (quadrature phase shift keying) and OQPSK (offset quadrature phase shift keying) modulation types to modulate a continuous stream of the selected data pattern. QPSK and OQPSK modulations transmit data at the rate of 2 bits per symbol. You can choose from QPSK, IS95 QPSK, Gray Coded QPSK, OQPSK, and IS95 OQPSK.

Softkey Locations

Custom: **Mode** > **Custom** > **Modulation Type** > **Select** > **PSK** > **QPSK and OQPSK**

Other Formats: **Mode** > **TDMA** > *desired format* > **Modify Standard** > **Modulation Type** > **Select** > **PSK** > **QPSK and OQPSK**

Loading a QPSK and OQPSK I/Q Map into the Table Editor

Pressing this softkey displays a menu of QPSK (quadrature phase shift keying) and OQPSK (offset quadrature phase shift keying) modulation types that you can load into the I/Q table editor. For details on editing I/Q maps, see [“Mapping Symbol Positions with the I/Q Table Editor”](#) on page 2 -15.

Softkey Locations

Custom: **Mode** > **Custom, Modulation Type** > **Define User I/Q** > **Load Default I/Q Map** > **PSK** > **QPSK and OQPSK**

Other Formats: **Mode** > **TDMA** > *desired format* > **Modify Standard** > **Modulation Type** > **Define User I/Q** > **Load Default I/Q Map** > **PSK** > **QPSK and OQPSK**

R

Rate Full Half

Press this softkey to toggle between NADC full- or half-rate. When you select full-rate, timeslots 1, 2, and 3 are paired with timeslots 4, 5, and 6, respectively. Select half-rate for 6 individual timeslots. Notice that your selection, either full-rate or half-rate, is shown on the display directly above the timeslot pattern visual representation.

Default Value: Full-rate

NADC and PDC: **Mode** > TDMA > *desired format* >
Data Format Pattern Framed > Configure Timeslots > Rate Full Half

Recall Secondary Frame State

Pressing this softkey recalls the last instrument state saved as the data pattern for the secondary frame. This will overwrite the current instrument state. When the secondary frame state is turned on, the secondary frame will be generated using the recalled instrument state.

Softkey Location: **Mode** > TDMA > *desired format* >
Data Format Pattern Framed > Configure Timeslots > Configure Frame >
Recall Secondary Frame State

Rectangle

Press this softkey to select the one-symbol wide rectangle pre-modulation filter in either the Select (filter) menu or the Load Default FIR menu.

See Also

- [“Display FFT”](#) on page 3 -74
- [“Display Impulse Response”](#) on page 3 -75
- [“Filter Symbols”](#) on page 3 -95

In the Select (filter) Menu

In this menu, pressing the **Rectangle** softkey selects this FIR filter for use in a custom modulation setup.

Softkey Locations

Custom: **Mode** > Custom > Filter > Select > Rectangle

Other Formats: **Mode** > TDMA > *desired format* > Modify Standard >
Filter > Select > Rectangle

In the Load Default FIR Menu

In this menu, pressing the **Rectangle** softkey followed by **Generate** loads the FIR table editor with the coefficient values for the filter. The number of filter symbols are defined in this menu. If you change a parameter after loading the filter coefficients, press the **Generate** softkey again to reload the FIR table.

Softkey Locations

Custom: **Mode > Custom > Filter > Define User FIR > Load Default FIR > Rectangle**

Other Formats: **Mode > TDMA > *desired format* > Modify Standard > Filter > Define User FIR > Load Default FIR > Rectangle**

Rename

Press this softkey to rename a file in the Bit File Editor.

Softkey Locations

Custom: **Mode > Custom > Data > User File > Edit File > Rename**

Other Formats: **Mode > TDMA > *desired format* > Data > User File > Edit File > Rename**

Or: **Mode > TDMA > *desired format* > Data Format Pattern Framed > Configure Timeslots > Configure *desired timeslot type* > Data > User File > Edit File > Rename**

Reset & Run

Press this softkey to select Reset & Run External Frame Trigger mode.

In Reset & Run External Frame Trigger mode, the trigger input latch is reset by a register bit in the status byte. When the register bit is released, the next trigger signal will reset and start the pattern. Prior to the trigger signal, the pattern waits at last bit until triggered. Pattern will continue to run repeatedly, independent of trigger until trigger input latch bit is toggled in the status byte. Once the trigger input latch register bit is toggled, the pattern will play to the end and wait at the last bit for the next trigger signal.

Softkey Location: **Mode > TDMA > *desired format* > Data Format Pattern Framed > Frame Repeat Single Cont > Frame Trigger > Ext > Reset & Run**

Restore DECT Factory Default

Press this softkey to reset DECT configuration to the factory default values. This softkey is a convenience feature for quickly resetting all DECT values.

Softkey Location: **Mode > TDMA > DECT > Restore DECT Factory Default**

Restore Default Burst Shape

Press this softkey to reset the burst parameters to their default values.

You can also use other keys in this menu to change each of the burst characteristics individually.

Default Values

	Rise Time, bits	Rise Delay, bits	Fall Time, bits	Fall Delay, bits	Shape Type
Custom	5.860	0.000	5.470	0.000	sine
DECT	13.797	-3.250	11.529	2.875	sine
EDGE	12.700	4.400	10.300	1.200	sine
GSM	4.224	0.000	3.440	0.125	sine
NADC	5.860	-1.000	5.470	-1.000	sine
PDC	5.470	0.000	3.830	-0.500	sine
PHS	4.976	-1.500	4.544	-1.500	sine
TETRA	9.376	-1.000	7.814	0.000	sine

Softkey Locations

Custom: **Mode** > **Custom** > **Burst Shape** > **Restore Default Burst Shape**

Other Formats: **Mode** > **TDMA** > *desired format* > **Modify Standard** > **Burst Shape** > **Restore Default Burst Shape**

Restore Default Filter

Press this softkey to replace the current FIR filter with the default filter.

Default Values

Custom, NADC, and TETRA: Root Nyquist $\alpha = 0.350$

DECT: Gaussian BbT = 0.500

EDGE: EDGE

GSM: Gaussian BbT = 0.300

PDC and PHS: Root Nyquist $\alpha = 0.500$

Softkey Locations

Custom: **Mode** > **Custom** > **Filter** > **Restore Default Filter**

Other Formats: **Mode** > **TDMA** > *desired format* > **Modify Standard** > **Filter** > **Restore Default Filter**

Restore Default Modulation Type

Press this softkey to restore the default modulation type for the format currently selected.

Default Values:

DECT: 2-Level FSK with a deviation of 288 kHz

GSM: MSK with 90 degree phase

All Other Formats: $\pi/4$ DQPSK

Softkey Locations

Custom: **Mode** > **Custom** > **Modulation Type** > **Restore Default Modulation Type**

Other Formats: **Mode** > **TDMA** > *desired format* > **Modify Standard** > **Modulation Type** > **Restore Default Modulation Type**

Restore Default Symbol Rate

Press this softkey to reset the transmission symbol rate to the default value. This softkey is a convenience feature for quickly resetting the symbol rate. You can also change the symbol rate by pressing the **Symbol Rate** softkey.

Default Values

Custom: 24.300 ksps NADC: 24.300 ksps

DECT: 1.152000 Msps PDC: 21.000 ksps

EDGE: 270.833333 ksps PHS: 192.000 ksps

GSM: 270.833333 ksps TETRA: 18.000 ksps

Softkey Locations

Custom: **Mode** > **Custom** > **Symbol Rate** > **Restore Default Symbol Rate**

Other Formats: **Mode** > **TDMA** > *desired format* > **Modify Standard** > **Symbol Rate** > **Restore Default Symbol Rate**

Restore EDGE Factory Default

Press this softkey to reset EDGE configuration to the factory default values.

Softkey Location: **Mode > TDMA > EDGE (Rev 8.3.0 Release 1999) > Restore EDGE Factory Default**

Restore GSM Factory Default

Press this softkey to reset GSM configuration to the factory default values.

Softkey Location: **Mode > TDMA > GSM > Restore GSM Factory Default**

Restore NADC Factory Default

Press this softkey to reset NADC configuration to the factory default values.

Softkey Location: **Mode > TDMA > NADC > Restore NADC Factory Default**

Restore PDC Factory Default

Press this softkey to reset PDC configuration to the factory default values.

Softkey Location: **Mode > TDMA > PDC > Restore PDC Factory Default**

Restore PHS Factory Default

Press this softkey to reset PHS configuration to the factory default values.

Softkey Location: **Mode > TDMA > PHS > Restore PHS Factory Default**

Restore TETRA Factory Default

Press this softkey to reset TETRA configuration to the factory default values.

Softkey Location: **Mode > TDMA > TETRA > Restore TETRA Factory Default**

R-GSM Base Pressing this softkey selects R-GSM 900 Base as the channel band for EDGE or GSM. R-GSM 900 Base contains channels 0 through 124 and 955 through 1023.

Softkey Location: **Mode > TDMA > *desired format* > Freq Channels > Channel Band > R-GSM Base**

R-GSM Mobile

Pressing this softkey selects R-GSM 900 Mobile as the channel band for EDGE and GSM. R-GSM 900 Mobile contains channels 0 through 124 and 955 through 1023.

Softkey Location: **Mode** > **TDMA** > *desired format* > **Freq Channels** > **Channel Band** > **R-GSM Mobile**

Rise Delay

Press this softkey to make the burst shape rise delay the active function. The minimum and maximum range of values allowed depends on the modulation type and the symbol rate.

Default Values

Custom: 0.000 bits	NADC: -1.000 bits
DECT: -3.250 bits	PDC: 0.000 bits
EDGE: 4.400 bits	PHS: -1.500 bits
GSM: 0.000 bits	TETRA: -1.000 bits

Softkey Locations

Custom: **Mode** > **Custom** > **Burst Shape** > **Rise Delay**

Other Formats: **Mode** > **TDMA** > *desired format* > **Modify Standard** > **Burst Shape** > **Rise Delay**

Rise Time

Press this softkey to make the burst shape rise time the active function. Minimum and maximum values depend on modulation type and symbol rate.

Default Values

Custom: 5.860 bits	NADC: 5.860 bits
DECT: 13.797 bits	PDC: 5.470 bits
EDGE: 12.700 bits	PHS: 4.976 bits
GSM: 4.224 bits	TETRA: 9.376 bits

Softkey Locations

Custom: **Mode** > **Custom** > **Burst Shape** > **Rise Time**

Other Formats: **Mode** > **TDMA** > *desired format* > **Modify Standard** > **Burst Shape** > **Rise Time**

Root Nyquist Press this softkey to select the Root Nyquist (root-raised cosine) pre-modulation filter in either the Select (filter) menu or the Load Default FIR menu.

See Also

- “[Display FFT](#)” on page 3 -74
- “[Display Impulse Response](#)” on page 3 -75
- “[Filter Alpha](#)” on page 3 -93

In the Select (filter) Menu

In this menu, pressing the **Root Nyquist** softkey selects this FIR filter for use in a custom modulation setup.

Softkey Locations

Custom: **Mode > Custom > Filter > Select > Root Nyquist**

Other Formats: **Mode > TDMA > *desired format* > Modify Standard > Filter > Select > Root Nyquist**

In the Load Default FIR Menu

In this menu, pressing the **Root Nyquist** softkey followed by **Generate** loads the FIR table editor with the coefficient values for the filter. The filter alpha and number of filter symbols are defined with the softkeys in this menu. If you change a parameter after loading the filter coefficients, press the **Generate** softkey again to reload the FIR table.

Softkey Locations

Custom: **Mode > Custom > Filter > Define User FIR > Load Default FIR > Root Nyquist**

Other Formats: **Mode > TDMA > *desired format* > Modify Standard > Filter > Define User FIR > Load Default FIR > Root Nyquist**

S**S****DECT Format**

Press this softkey to make the 16-bit synchronization word (S) the active function. The preset hexadecimal value (when normal preset is selected) for synchronization reflects the DECT format. The current value for S appears in the S field near the bottom of the text area of the display.

Default Values: E98A (RFP timeslots), 1675 (PP timeslots)

DECT: **Mode > TDMA > DECT > Data Format Pattern Framed > Configure Timeslots > Configure Traffic Bearer > S**

S is also located in the portable part Configure Traffic Bearer menu and the radio fixed part and portable part Low Capacity menus.

GSM Format

Press this softkey to make the 1-bit binary stealing flag for both stealing flag fields in the normal burst timeslot the active function. Although the stealing flag fields accept binary values of zero or one, the front panel data entry is actually hexadecimal. Any value entered that is greater than one is automatically clipped back to a value of one.

Default Value: 0

Softkey Location: **Mode > TDMA > GSM > Data Format Pattern Framed > Configure Timeslots > Configure Normal > S**

SA

Press this softkey to make the 16-bit slow associated control channel (SACCH) the active function. The preset hexadecimal value (when normal preset is selected) for SACCH reflects the PHS format, displayed in the SA field near the bottom of the text area of the display.

Default Value: 8000

Softkey Location: **Mode > TDMA > PHS > Data Format Pattern Framed > Configure Timeslots > Configure TCH > SA**

Or: **Mode > TDMA > PHS > Data Format Pattern Framed > Configure Timeslots > Control Channel Dnlink Uplink > Configure TCH > SA**

SACCH

Press this softkey to make the 12-bit slow associated control channel (SACCH) the active function. The preset hexadecimal value (when normal preset is selected) for SACCH reflects the NADC or PDC format, displayed in the SACCH field near the bottom of the text area of the display.

Default Values

PDC: 0000 (UP TCH and Up VOX), 000000 (Dn TCH)

NADC: 000

NADC and PDC: **Mode > TDMA > *desired format* >**

Data Format Pattern Framed > Configure Timeslots > Configure Up TCH > SACCH

SACCH is also located in the Configure Down TCH menu (NADC and PDC), and Configure UP VOX menu (PDC).

Save Secondary Frame State

Pressing this softkey:

- Saves the current instrument state to memory using the selected format (such as DECT) as the prefix and `_SECONDARY_FRAME` as the suffix.
- Moves the data pattern to the end of the data generator memory where it can be used to generate the secondary frame data.

When you turn on the secondary frame state, the secondary frame is generated as needed using the saved instrument state.

Softkey Location: **Mode > TDMA > *desired format* > Data Format Pattern Framed > Configure Timeslots > Configure Frame > Save Secondary Frame State**

Scramble Off On

Press this softkey to enable the scramble capability. When **Scramble Off On** is set to **On**, the data in the related fields will be scrambled using the seed value set with the **Scramble Seed** softkey.

Default Value: Off

PHS and TETRA: **Mode > TDMA > *desired format* >**

Data Format Pattern Framed > Configure Timeslots > Configure Frame > Scramble Off On

Scramble Seed

Press this softkey to make scramble seed the active function. Scramble seed specifies the scramble starting point in the PRBS generator. Enter values in hexadecimal.

In the TETRA format, the 32-bit scramble seed comprises four fields. The two least significant bits are defined by the TETRA format as 1 (but you must input them anyway). The remaining 30 bits are the extended color code that is divided into three fields:

- mobile country code
- mobile network code
- color code

The two least-significant bits are appended to the color code, so if, for example, you set a color code of 1, a scramble seed of 7 is required.

Range (hexadecimal)

PHS: 000 through 3FF

TETRA: 00000000 through FFFFFFFF

Default Values

PHS: 3FF

TETRA: FFFFFFFF

PHS and TETRA: **Mode > TDMA > *desired format* > Data Format Pattern Framed > Configure Timeslots > Configure Frame > Scramble Seed**

Secondary Frame Off On

Press this softkey to toggle the secondary frame operating state. The secondary frame is a data pattern that coexists with the primary (the pattern that can be modified either from the front panel or by using SCPI commands). The secondary pattern is generated from the instrument state saved using the **Save Secondary State** softkey.

Default Value: Off

Softkey Location: **Mode > TDMA > *desired format* > Data Format Pattern Framed > Configure Timeslots > Configure Frame > Secondary Frame Off On**

Secondary Frame Trigger

Pressing this softkey displays a menu of choices for triggering the use of either the primary frame or the secondary frame (whichever is not being currently used). You can choose to trigger using the front panel **Trigger** key, an external trigger supplied to the PATTERN TRIG IN connector, or by either a *TRG command or GET (group execute trigger) signal sent over GPIB.

Default Value: Ext

Softkey Location: **Mode** > **TDMA** > *desired format* >
Data Format Pattern Framed > **Configure Timeslots** > **Configure Frame** >
Secondary Frame Trigger

Select

There are two softkeys named Select, one in the Filter menu and one in the Modulation type menu. In the Filter menu, you can select a pre-modulation filter type; in the Modulation type menu, you can select a modulation.

Selecting a Filter

In the Filter menu, press this softkey to access a menu for selecting the pre-modulation filter type. The pre-defined choices are Root Nyquist, Nyquist, Gaussian, several IS-95 filters, User FIR, Rectangle, EDGE (EDGE modulation type only), APCO 25 C4FM, and UN3/4 GSM Gaussian. In addition to the pre-defined filters, you can access the catalog of files stored in the signal generator memory. You can select any filter that you have either created externally and downloaded into memory, or that you have created internally in the Define User FIR menu and then subsequently stored.

Default Values

EDGE: EDGE

Custom, NADC, PHS, PDC, TETRA: Root Nyquist

DECT, GSM: Gaussian

Softkey Locations

Custom: **Mode** > **Custom** > **Filter** > **Select**

Other Formats: **Mode** > **TDMA** > *desired format* > **Modify Standard** >
Filter > **Select**

Selecting a Modulation

In the Modulation Type menu, press this softkey to access a menu for defining the modulation types. In addition to the pre-defined modulations, you can access a catalog of FSK or I/Q files stored in the signal generator memory, where you can select a modulation that you have created and stored in either the Define User FSK or Define User I/Q menu.

Default Values

Custom, NADC, PDC, PHS, and TETRA: $\pi/4$ DQPSK

DECT: 2-Lvl FSK

EDGE: EDGE

GSM: MSK

Softkey Locations

Custom: **Mode** > **Custom** > **Modulation Type** > **Select**

Other Formats: **Mode** > **TDMA** > *desired format* > **Modify Standard** > **Modulation Type** > **Select**

Select File

Press this softkey to select a file in the displayed catalog of binary files. To make your selection, scroll through the list using the front panel knob or up and down arrow keys until the desired file is highlighted; then press **Select File**. If you select a custom file as a data pattern for modulated transmissions, *UserFile* appears in the *Data* field of the text display. If you select a custom file as the modulation type, *UserFile* appears in the *Mod Type* field of the text display.

Select File is located in each of the catalogs of files.

Sine

Pressing this softkey to specify sine for the timeslot burst shape. Sine, as it is modified by the default burst rise and fall values, is the default burst shape.

Softkey Location: **Mode** > **TDMA** > **EDGE (Rev 8.3.0 Release 1999)** > **Modify Standard** > **Burst Shape** > **Burst Shape Type** > **Sine**

Single Shot

Press this softkey to select Single Shot External Frame Trigger mode.

In Single Shot External Frame Trigger mode, the pattern waits at the last bit until triggered. If the pattern is playing and a trigger signal is received before the last bit of the pattern has been played, the trigger signal is ignored. If triggered after end of pattern, the pattern resets and runs.

Softkey Location: **Mode** > **TDMA** > *desired format* > **Data Format Pattern Framed** > **Frame Repeat Single Cont** > **Frame Trigger** > **Ext** > **Single Shot**

SS

Press this softkey to make the 41-bit synchronization sequence in the access burst timeslot the active function. The preset hexadecimal value (when normal preset is selected) for SS reflects the GSM format, and appears in the SS field near the bottom of the text area of the display.

Default Value: 096FF335478

Softkey Location: **Mode > TDMA > GSM > Data Format Pattern Framed > Configure Timeslots > Timeslot Type > Access > Configure Access > SS**

SSB Press this softkey to make the 120-bit synchronization block bits (SSB) the active function. The current hexadecimal value for synchronization block bits is displayed in the SSB field near the bottom of the text area of the display.

Default Value: 00000000000000000000000000000000

Softkey Location: **Mode > TDMA > TETRA > Data Format Pattern Framed > Configure Timeslots > Timeslot Type > Dn Sync Cont > Configure Dn Sync Cont > SSB**

Or: **Mode > TDMA > TETRA > Data Format Pattern Framed > Configure Timeslots > Timeslot Type > Dn Sync Disc > Configure Dn Sync Disc > SSB**

Standard Press this softkey select the standard frequency band:

DECT and PHS: channels 1 through 9

TETRA: channels 1 through 100

DECT, PHS, and TETRA: **Mode > TDMA > *desired format* > Freq Channels > Channel Band > Standard**

Store To File Press this softkey to store the selected custom configuration to a file in non-volatile memory for later recall and use.

Store To File is located in each of the catalogs of files.

STS Press this softkey to make the 38-bit synchronization training sequence bits (STS) the active function. The preset hexadecimal value (when normal preset is selected) for the synchronization training sequence bits reflects the TETRA format, and appears in the STS field near the bottom of the text area of the display.

Default Value: 30673A7067

Softkey Location: **Mode > TDMA > TETRA > Data Format Pattern Framed > Configure Timeslots > Timeslot Type > Dn Sync Cont > Configure Dn Sync Cont > STS**

Or: **Mode > TDMA > TETRA > Data Format Pattern Framed > Configure Timeslots > Timeslot Type > Dn Sync Disc > Configure Dn Sync Disc > STS**

SW

Press this softkey to make the 20-bit frame synchronization word the active function. The preset hexadecimal value (when normal preset is selected) for SW reflects the PDC format, and appears in the SW field near the bottom of the text area of the display.

Default Values: 785B4 (Up TCH and Up VOX), 87A4B (Dn TCH)

Softkey Location: **Mode > TDMA > PDC > Data Format Pattern Framed > Configure Timeslots > Configure Up TCH > SW**

SW is also located in the Configure Down TCH and Configure Up VOX menus.

Symbol Rate

Press this softkey to make the transmission symbol rate the active function.

Range

EDGE: 50.863 sps through 8.333333333 ksps

Other Formats: 47.684 sps through 12.500000 Msps

NOTE

The range varies, depending on the modulation type and the data that is being transmitted.

Default Values

Custom, NADC: 24.300 ksps PDC: 21.000 ksps

DECT: 1.152000 Msps PHS: 192.000 ksps

EDGE and GSM: 270.833 ksps TETRA: 18.000 ksps

Softkey Locations

Custom: **Mode > Custom > Symbol Rate > Symbol Rate**

Other Formats: **Mode > TDMA > *desired format* > Modify Standard > Symbol Rate > Symbol Rate**

Symbol Sync Out

Press this key to access a menu from which you can modify the output at the SYMBOL SYNC OUT rear panel BNC/SMB connector.

Softkey Location: **Mode > TDMA > EDGE (Rev 8.3.0Release 1999) > BNC MUX Settings > Symbol Sync Out**

SYNC

In the NADC Format

Press this softkey to make the 28-bit synchronization word the active function. The current value appears in the SYNC field near the bottom to the text area of the display.

Default Value: A91DE4A

Softkey Location: **Mode > TDMA > NADC > Data Format Pattern Framed > Configure Timeslots > Configure Up TCH > SYNC**

SYNC is also located in the Configure Down TCH menu.

In the PHS Format

Press this softkey to select synchronization burst as the timeslot type for the active timeslot.

Softkey Location: **Mode > TDMA > PHS > Data Format Pattern Framed > Configure Timeslots > Timeslot Type > SYNC**

Or: **Mode > TDMA > PHS > Data Format Pattern Framed > Configure Timeslots > Control Channel Dnlink Uplink > Timeslot Type > SYNC**

Sync

Press this softkey to select synchronization as the timeslot type for the active timeslot. Synchronization is a downlink burst that allows the mobile to synchronize in time with the base station.

When you select **Sync** for a timeslot, the visual representation of the timeslot pattern on the display updates to show the selection.

Softkey Location: **Mode > TDMA > GSM > Data Format Pattern Framed > Configure Timeslots > Timeslot Type > Sync**

Sync Out

Press this softkey to display a menu of choices for outputting a 1-bit synchronization signal to the EVENT 1 rear panel connector. You can set the synchronization signal to occur at the beginning of a data pattern, at the beginning of a frame, at the beginning of a selected timeslot, or at the beginning of each timeslot in a frame.

Default Value: Begin Pattern

Softkey Locations

Custom: **Mode > Custom > Sync Out**

Other Formats: **Mode > TDMA > *desired format* > Sync Out**

Sync Out Offset

Press this softkey to make synchronization offset the active function.

Range

Custom: As large as the number of bits in the timeslot selected in the Sync Out menu

DECT: -479 through +479 bits

EDGE and GSM: -155 through +155 bits

NADC, PDC: -323 through +323 bits

PHS: -239 through +239 bits

TETRA: -509 through +509 bits

Default Value: 0 bits

Softkey Locations

Custom: **Mode** > **Custom** > **Sync Out** > **Sync Out Offset**

Other Formats: **Mode** > **TDMA** > *desired format* > **Data Format Pattern Framed** > **Sync Out** > **Sync Out Offset**

T

T1, T2

Press these softkeys to edit the 9-bit tail fields in the normal burst timeslot. Use hexadecimal to enter the value; the signal generator will convert it to binary.

Range: 0 through 1FF

Default Value: 1FF

Softkey Location: **Mode > TDMA > EDGE (Rev 8.3.0 Release 1999) > Data Format Pattern Framed > Configure Timeslots > Configure Normal > T1 (or T2)**

TCH

There are two softkeys named **TCH**: one in the Timeslot Type menu, and one in the downlink Configure TCH menu

In the Timeslot Type Menu

In this menu, this softkey selects traffic channel as the timeslot type for the active timeslot. When you select **TCH** for a timeslot, the visual representation of the timeslot pattern on the display immediately updates to show the configuration.

Softkey Location: **Mode > TDMA > PHS > Data Format Pattern Framed > Configure Timeslots > Control Channel Dnlink Uplink > Timeslot Type > TCH**

Or: **Mode > TDMA > PHS > Data Format Pattern Framed > Configure Timeslots > Timeslot Type > TCH**

In the Configure TCH Menu

In this menu, this softkey displays a menu of choices for internal data generation (PN9, PN15, fixed, 4-bit repeating sequences, set patterns of ones and zeroes) or you can choose to supply your own data (download a binary file or input data using the DATA INPUT connector) for configuring the timeslot TCH fields.

Default Value: PN23

Softkey Location: **Mode > TDMA > PHS > Data Format Pattern Framed > Configure Timeslots > Configure TCH > TCH**

TCH All

Press this softkey to select traffic channel as the timeslot type for all timeslots in either the uplink or the downlink channel, depending on which is active.

When you select **Up TCH All**, the visual representation of the timeslot pattern on the display immediately updates.

Softkey Location: **Mode > TDMA > PHS > Data Format Pattern Framed > Configure Timeslots > Timeslot Type > TCH All**

Or: **Mode > TDMA > PHS > Data Format Pattern Framed > Configure Timeslots > Control Channel Dnlink Uplink > Timeslot Type > TCH All**

TCH/FS

Use this softkey to select a full rate speech traffic channel as the timeslot type for the active timeslot.

Softkey Location: **Mode > TDMA > GSM > Data Format Pattern Framed > Configure Timeslots > Configure Normal > E > Multiframe Channel > TCH/FS**

TDMA

Pressing this softkey reveals a menu of softkeys for generating data patterns that are formatted into a framed structure (where the data bits are located in fields defined by the individual TDMA protocols) or for generating just the data pattern where the data sequence can be output a single time or repeatedly.

Softkey Location: **Mode > TDMA**

TETRA

Pressing this softkey opens a menu of softkeys where you can generate a data pattern formatted into either a framed structure (where the data bits are located in fields defined by the TETRA protocol) or a sequence that can be output one or more times.

Softkey Location: **Mode > TDMA > TETRA**

TETRA Off On

Press this softkey to toggle the TETRA communications format. Setting **TETRA Off On** to **On** sets up the internal hardware to generate the structure that follows the TETRA format. The internal I/Q modulator generates $\pi/4$ DQPSK digital modulation, and the **TETRA** and **I/Q** annunciators appear in the display. Although the digital modulation is enabled with this softkey, the RF carrier is modulated by the enabled modulation only when you have also set **Mod On/Off** to **On**.

Setting **TETRA Off On** to **On** presets the following softkeys in the I/Q menu: **I/Q Off On** is set to **On** and **I/Q Source** is set to **Int I/Q**. You can override these selections in the I/Q menu.

Default Value: Off

Softkey Location: **Mode > TDMA > TETRA > TETRA Off On**

Timeslot

Press this softkey to select a timeslot to be configured. Choose any of the available timeslots. This selection applies to the timeslots in the active channel.

Default Timeslot

NADC, PHS, TETRA: 1

Other Formats: 0

Softkey Location: **Mode > TDMA > *desired format* > Data Format Pattern Framed > Configure Timeslots > Timeslot #**

Timeslot Ampl Main Delta (Option UNA only)

Press this softkey to toggle the selected timeslot RF output power as main or alternate (delta). To configure the alternate amplitude, use the menu provided by pressing **Ampl > Alternate Amplitude**. Here you will find a set of softkeys that enable you to configure the alternate amplitude's state, delta, and triggering functions. When a format is activated, the necessary coupling is provided to achieve the optimal configuration for alternate amplitude control. This feature is available only with Option UNA, Alternate Power Control.

Default Value: Main

Softkey Location: **Mode > TDMA > *desired format* > Data Format Pattern Framed > Configure Timeslots > Timeslot Ampl Main Delta**

Timeslot Off On

Press this softkey to toggle the active timeslot on and off. The visual representation of the timeslot pattern reflects the timeslot status in the active channel.

Default Values

DECT, EDGE, GSM, and PDC: On (timeslot 0)

NADC and PHS: On (timeslot 1)

TETRA: On (timeslot 1), Off (timeslots 2 through 4)

Softkey Location: **Mode > TDMA > *desired format* > Data Format Pattern Framed > Configure Timeslots > Timeslot Off On**

Timeslot Type

Pressing this softkey displays a menu where you can set the timeslot type for the active timeslot. The visual representation of the timeslot pattern on the display is updated to show the current selection.

Default Values

DECT: Traffic Bearer (timeslot 0)

EDGE and GSM: Normal (timeslot 0)

NADC: Up TCH (timeslot 1)

PDC: Up TCH (timeslot 0)

PHS: TCH (downlink 1)

TETRA: Uplink Normal (all timeslots)

Softkey Locations

DECT: **Mode > TDMA > DECT > Data Format Pattern Framed > Configure Timeslots > Timeslot Type**

Or: **Mode > TDMA > DECT > Data Format Pattern Framed > Configure Timeslots > Transmit Link RFP PP > Timeslot Type**

EDGE and GSM: **Mode > TDMA > *desired format* > Data Format Pattern Framed > Configure Timeslots > Timeslot Type**

NADC: **Mode > TDMA > NADC > Data Format Pattern Framed > Configure Timeslots > Timeslot Type**

PDC: Mode > TDMA > PDC > Data Format Pattern Framed > Configure Timeslots > Timeslot Type

PHS: Mode > TDMA > PHS > Data Format Pattern Framed > Configure Timeslots > Timeslot Type

Or: Mode > TDMA > PHS > Data Format Pattern Framed > Configure Timeslots > Control Channel Dnlink Uplink > Timeslot Type

TETRA: Mode > TDMA > TETRA > Data Format Pattern Framed > Configure Timeslots > Timeslot Type

Traffic Bearer

Press this softkey to select traffic bearer as the timeslot type for the active timeslot. When you select **Traffic Bearer** for a timeslot, the visual representation of the timeslot type on the display immediately updates.

Softkey Location: Mode > TDMA > DECT > Data Format Pattern Framed > Configure Timeslots > Timeslot Type > Traffic Bearer

Or: Mode > TDMA > DECT > Data Format Pattern Framed > Configure Timeslots > Transmit Link RFP PP > Timeslot Type > Traffic Bearer

Traffic Bearer with Z Field

Press this softkey to select traffic bearer with Z field as the timeslot type for the active timeslot. When you select **Traffic Bearer with Z Field** for a timeslot, the visual representation of the timeslot type on the display immediately updates.

Softkey Location: Mode > TDMA > DECT > Data Format Pattern Framed > Configure Timeslots > Timeslot Type > Traffic Bearer with Z Field

Or: Mode > TDMA > DECT > Data Format Pattern Framed > Configure Timeslots > Transmit Link RFP PP > Timeslot Type > Traffic Bearer with Z Field

Transmit Link RFP PP

Press this softkey to toggle between the twelve radio fixed part (RFP) timeslots and the twelve portable part (PP) timeslots. Any timeslot number, type, or configuration settings apply to the chosen RFP or PP timeslot selection. RFP and PP timeslots can be active concurrently.

Default Value: RFP

Softkey Location: Mode > TDMA > DECT > Data Format Pattern Framed > Configure Timeslots > Transmit Link RFP PP

Trigger In Polarity Neg Pos

Used this softkey to choose the polarity of the signal at the TRIGGER IN BNC connector that triggers an event. **Pos** refers to the rising edge and **Neg** refers to the falling edge.

Default Value: Pos

Softkey Location: **Mode > TDMA > *desired format* > Data Format Pattern Framed > Configure Timeslots > Configure Frame > Secondary Frame Trigger > Trigger In Polarity Neg Pos**

Trigger Key

Press this softkey to select the front panel **Trigger** key as the:

- Pattern trigger for a single output of a modulated data transmission that is *not* framed. **Trigger Key** is displayed under the **Pattern Trigger** softkey.
- Frame trigger to toggle between the primary and/or secondary framed data.

Once selected, you can trigger a single event at any time by pressing the **Trigger** key.

NOTE

Pattern Repeat and Pattern Trigger functions are *not* available if you use either a PN data sequence, or an external data source.

Softkey Locations

Custom: **Mode > Custom > Pattern Repeat Single > Pattern Trigger > Trigger Key**

Other Formats: **Mode > TDMA > *desired format* > Pattern Repeat Single Cont > Pattern Trigger > Trigger Key**

Or: **Mode > TDMA > *desired format* > Data Format Pattern Framed > Frame Repeat Single Cont > Frame Trigger > Trigger Key**

Or: **Mode > TDMA > *desired format* > Data Format Pattern Framed > Configure Timeslots > Configure Frame > Secondary Frame Trigger > Trigger Key**

TS

Press this softkey to make the training sequence (TS) the active function. The preset hexadecimal value (when normal preset is selected) for TS reflects the current format, and appears in the TS field near the bottom of the text area of the display.

Default Values

EDGE: TSC0

GSM: TSC0 (Normal and Dummy), B962040F2D45761B (Sync)

TETRA: 343A74 (uplink normal, downlink normal continuous and discontinuous)

2743A743 (uplink control 1 and 2)

Softkey Locations

EDGE and GSM: **Mode > TDMA > *desired format* >**

Data Format Pattern Framed > Configure Timeslots > Configure Normal > TS

TETRA: **Mode > TDMA > TETRA > Data Format Pattern Framed >**

Configure Timeslots > Configure Up Normal > TS

In the EDGE and GSM formats, **TS** is also located in the Configure Dummy and Configure Sync menus.

In the TETRA format, **TS** is also located in the uplink configure control 1 and control 2 menus, and in the downlink configure normal continuous and discontinuous menus.

TSC0 - TSC7 Press these softkeys to select a training sequence code for EDGE or GSM. The hexadecimal values for each training sequence code are shown in the following table. You can edit any of these values with the Custom TS softkey.

Training Sequence Code	EDGE Hexadecimal Value	GSM Hexadecimal Value
TSC0	3F3F9E49FFF3FF3F9E49	0970897
TSC1	3F3C9E49E493FF3C9E49	0B778B7
TSC2	39FFF24F24F3F9FFF24F	10EE90E
TSC3	39FF924F279FF9FF924F	11ED11E
TSC4	3FE4F3C93F9FFFE4F3C9	06B906B
TSC5	39FC93CF27FFF9FC93CF	13AC13A
TSC6	0F3F9249E4FFCF3F9249	29F629F
TSC7	093C927FE7F3C93C927F	3BC4BBC

Softkey Location: **Mode > TDMA > *desired format* > Data Format Pattern Framed > Configure Timeslots > Configure Normal > TS > TSC0 (or TSC1 - TSC7)**

U

UN3/4 GSM Gaussian

This key selects a UN3/4 delay compatible, GSM, Gaussian filter with a 0.300 fixed BbT.

Softkey Locations

Custom: **Mode > Custom > Filter > Select > UN3/4 GSM Gaussian**

Other Formats: **Mode > TDMA > *desired format* > Modify Standard > Filter > Select > UN3/4 GSM Gaussian**

Uncoded

Press this softkey to select an uncoded channel which is a normal EDGE burst that carries only PN9 or PN15 bits.

Softkey Location: **Mode > TDMA > EDGE (Rev 8.3.0 Release 1999) > Data Format Pattern Framed > Configure Timeslots > Configure Normal > E > Multiframe Channel > Uncoded**

Up Control 1

Press this softkey to select uplink control subslot 1 as the timeslot type for the active timeslot.

You cannot mix uplink and downlink timeslots. If a timeslot is designated as downlink, it changes to uplink if you designate any other timeslot as uplink. The following table shows the timeslot type interchange to a frame designated as downlink when uplink is selected.

From Continuous Downlink Timeslot	From Discontinuous Downlink Timeslot	To Uplink Timeslot
Dn Custom Cont	Dn Custom Disc	Up Custom
Dn Normal Cont	Dn Normal Disc	Up Normal
Dn Sync Cont	Dn Sync Disc	Up Custom

When you select **Up Control 1** for a timeslot, the visual representation of the timeslot pattern updates.

Softkey Location: **Mode > TDMA > TETRA > Data Format Pattern Framed > Configure Timeslots > Timeslot Type > Up Control 1**

Up Control 2 Press this softkey to select uplink control subslot 2 as the timeslot type for the active timeslot.

You cannot mix uplink and downlink timeslots. If a timeslot is designated as downlink, it changes to uplink if you designate any other timeslot as uplink. The following table shows the timeslot type interchange to a frame designated as downlink when uplink is selected.

From Continuous Downlink Timeslot	From Discontinuous Downlink Timeslot	To Uplink Timeslot
Dn Custom Cont	Dn Custom Disc	Up Custom
Dn Normal Cont	Dn Normal Disc	Up Normal
Dn Sync Cont	Dn Sync Disc	Up Custom

When you select **Up Control 1** for a timeslot, the visual representation of the timeslot pattern updates.

Softkey Location: **Mode > TDMA > TETRA > Data Format Pattern Framed > Configure Timeslots > Timeslot Type > Up Control 2**

Up Custom

Press this softkey to select an uplink custom timeslot type for the active timeslot. A custom timeslot is configured using an internally-generated data pattern, a downloaded sequence of bits stored in a user file, or by supplying external data. Uplink timeslots cannot be mixed with downlink timeslots. If you already have any timeslots designated as downlink, they will be changed to uplink when any other timeslot is designated as uplink. The custom timeslot is provided for users' flexibility; it is not a standard timeslot type.

From Continuous Downlink Timeslot	From Discontinuous Downlink Timeslot	To Uplink Timeslot
Dn Custom Cont	Dn Custom Disc	Up Custom
Dn Normal Cont	Dn Normal Disc	Up Normal
Dn Sync Cont	Dn Sync Disc	Up Custom

When you select **Up Custom** for a timeslot, the displayed representation of the timeslot pattern updates.

NADC, PDC, and TETRA: **Mode > TDMA > *desired format* > Data Format Pattern Framed > Configure Timeslots > Timeslot Type > Up Custom**

Uplink MCS-1

Press this softkey to select an uplink packet data traffic channel with block type 5 that is in compliance with GSM 05.03.

Softkey Location: **Mode > TDMA > GSM > Data Format Pattern Framed > Configure Timeslots > Configure Normal > E > Multiframe Channel > Uplink MCS-1**

Uplink MCS-5

Press this softkey to select an uplink packet data traffic channel with block type 9 that is in compliance with GSM 05.03. The MCS5 radio block contains a single RLC data block of 448 bits with a code rate of 0.37. This ensures that the maximum amount of Forward Error Correction (FEC) has been applied to the data.

Softkey Location: **Mode > TDMA > EDGE (Rev 8.3.0 Release 1999) > Data Format Pattern Framed > Configure Timeslots > Configure Normal > E > Multiframe Channel > Uplink MCS-5**

Uplink MCS-9

Press this softkey to select a uplink packet data traffic channel with block type 13 that is in compliance with GSM 05.03. The MCS9 radio block contains two RLC data blocks of 592 bits with a code rate of 1.0. No Forward Error Correction (FEC) has been applied to the data, thus reducing the overhead and enabling the fastest data rate transmission.

Softkey Location: **Mode > TDMA > EDGE (Rev 8.3.0 Release 1999) > Data Format Pattern Framed > Configure Timeslots > Configure Normal > E > Multiframe Channel > Uplink MCS-9**

Up Normal

Press this softkey to select uplink normal as the timeslot type for the active timeslot.

You cannot mix uplink and downlink timeslots. If a timeslot is designated as downlink, it changes to uplink if you designate any other timeslot as uplink. The following table shows the timeslot type interchange to a frame designated as downlink when uplink is selected.

From Continuous Downlink Timeslot	From Discontinuous Downlink Timeslot	To Uplink Timeslot
Dn Custom Cont	Dn Custom Disc	Up Custom
Dn Normal Cont	Dn Normal Disc	Up Normal
Dn Sync Cont	Dn Sync Disc	Up Custom

When you select **Up Normal** for a timeslot, the visual representation of the timeslot pattern updates.

Softkey Location: **Mode > TDMA > TETRA > Data Format Pattern Framed > Configure Timeslots > Timeslot Type > Up Normal**

Up TCH

Press this softkey to select uplink traffic channel (mobile to base station) as the timeslot type for the active timeslot. Uplink timeslots cannot be mixed with downlink timeslots. If you already have any timeslots designated as downlink, they will be changed to uplink when any other timeslot is designated as uplink.

When you select **Up TCH** for a timeslot, the visual representation of the timeslot pattern updates.

NADC and PDC: **Mode > TDMA > *desired format* > Data Format Pattern Framed > Configure Timeslots > Timeslot Type > Up TCH**

Up TCH All

Press this softkey to select uplink traffic channel (mobile to base station) as the timeslot type for all timeslots. When you select **Up TCH**, the frame pattern is bursted with RF power turning off during off timeslots.

When you select **Up TCH All**, the visual representation of the timeslot pattern updates.

NADC and PDC: **Mode > TDMA > *desired format* > Data Format Pattern Framed > Configure Timeslots > Timeslot Type > Up TCH All**

Up VOX

Press this softkey to select uplink voice activated transmission channel as the timeslot type for the active timeslot.

When you select **Up VOX** for a timeslot, the visual representation of the timeslot pattern updates.

Softkey Location: **Mode > TDMA > PDC > Data Format Pattern Framed > Configure Timeslots > Timeslot Type > Up VOX**

User File

Press this softkey to display the catalog of binary/bit files stored in the signal generator's memory. You can select a custom file from this catalog for the data pattern or burst shape. Scroll through the listed files, highlight the desired file, then press the **Select File** softkey.

User File appears in the Data field of the display. If you have selected **User File** for configuring timeslot data fields, the selected file appears in the Data field or the B field, both of which are located near the bottom of the text area of the display.

User files should exactly fill the data fields in a framed transmission (create the files to fill an integer number of frames). If the end of a user file does not coincide with the end of a frame, data is truncated in one of the following ways:

- Enough frames are generated to transmit as much of the data pattern as will fit into complete frames. The remaining bits of the data pattern (which are too few to completely fill a frame) are truncated.
- If two files of unequal sizes are selected for the same framed transmission, enough frames are generated to transmit as much of the data pattern of the largest file as will fit into complete frames. The remaining bits of the data pattern are truncated. The smaller file is repeated as many times as necessary to completely fill these frames. Data is truncated for the smaller file to coincide with the end of the last frame.
- If both a user file and a PN9 or PN15 file are selected for a framed transmission and the user file is shorter than the PN9/15, enough frames are generated to transmit the PN9/15. The end of the PN9/15 data coincides with the end of the last frame. The smaller user file is repeated as many times as necessary to completely fill these frames. Data is truncated for the smaller file to coincide with the end of the last frame.
- If both a user file and a PN9 file are selected for a framed transmission and the user's file is longer than the PN9, enough frames are generated to transmit as much of the data pattern as fits into *complete* frames. The remaining bits of the data pattern (which are too few to completely fill a frame) are truncated. The PN9 data is repeated as many times as necessary to completely fill the frames.

Softkey Locations

Custom: **Mode > Custom > Data > User File**

Other Formats: **Mode > TDMA > *desired format* > Data > User File**

Custom: **Mode > Custom > Burst Shape > Burst Shape Type > User File**

Other Formats: **Mode > TDMA > *desired format* > Modify Standard > Burst Shape > Burst Shape Type > User File**

DECT: **Mode > TDMA > DECT > Data Format Pattern Framed > Configure Timeslots > Configure Traffic Bearer > B field > User File**

User File is also located in the B field menus found in the portable part Configure Traffic Bearer menu and the radio fixed part and portable part Low Capacity menus, and also in the radio fixed part and portable part Configure Custom menus.

EDGE and GSM: **Mode > TDMA > *desired format* > Data Format Pattern Framed > Configure Timeslots > Configure Normal > E > User File**

User File is also located in the Configure Custom menu, and in the E menus found in the Configure Sync and Configure Access menus.

NADC: **Mode > TDMA > NADC > Data Format Pattern Framed > Configure Timeslots > Configure Up TCH > Data > User File**

User File is also located in the Configure Down Custom and Configure Up Custom menus, and in the Data menu found in the Configure Down TCH menu.

PDC: **Mode > TDMA > PDC > Data Format Pattern Framed > Configure Timeslots > Configure Up TCH > TCH > User File**

User File is also located in the Configure Down Custom and Configure Up Custom menus, and in the TCH menu found in the Configure Down TCH menu.

PHS: **Mode > TDMA > PHS > Data Format Pattern Framed > Configure Timeslots > Configure TCH > TCH > User File**

User File is also located in the Data menu found in the uplink Configure TCH menu, and in the downlink and uplink Configure Custom menus.

TETRA: **Mode > TDMA > TETRA > Data Format Pattern Framed > Configure Timeslots > Configure Up Normal > Data > User File**

User File is also located in the uplink and downlink Configure Custom menus, and in the Data menus found in every other TETRA Configure Timeslots menu.

User FIR

Press this softkey to display the catalog of FIR filter files stored in the signal generator's memory. You can select a custom filter from this catalog for a pre-modulation filter. Scroll through the listed files, highlight the desired file, then press the **Select File** softkey. `User FIR` appears in the `Filter` field of the display, and the file name is listed in the second line of the **Select** softkey.

Softkey Locations

Custom: **Mode** > **Custom** > **Filter** > **Select** > **User FIR**

Other Formats: **Mode** > **TDMA** > *desired format* > **Modify Standard** > **Filter** > **Select** > **User FIR**

User FSK

Press this softkey to display the catalog of FSK files stored in the signal generator's memory. To select a custom file from this catalog for an FSK modulation: scroll through the listed files, highlight the desired file, then press the **Select File** softkey. `User FSK` appears in the `Mod Type` field of the display, and both **User FSK** and the selected file name appear in the **Select Modulation Type** sub-menu.

Softkey Locations

Custom: **Mode** > **Custom** > **Modulation Type** > **Select** > **User FSK**

Other Formats: **Mode** > **TDMA** > *desired format* > **Modify Standard** > **Modulation Type** > **Select** > **User FSK**

User I/Q

Press this softkey to display the catalog of I/Q files where you can select a prestored configuration to use as the modulation type: scroll through the listed files, highlight the desired file, then press **Select File**. `User I/Q` is appears in the `Mod Type` field of the display, and **User I/Q** appears in the **Select Modulation Type** sub-menu.

Softkey Locations

Custom: **Mode** > **Custom** > **Modulation Type** > **Select** > **User I/Q**

Other Formats: **Mode** > **TDMA** > *desired format* > **Modify Standard** > **Modulation Type** > **Select** > **User I/Q**

UW

Press this softkey make the unique word (UW) the active function. The preset hexadecimal value (when normal preset is selected) for UW reflects the PHS format, and the current value for UW is displayed in the UW field near the bottom of the text area of the display.

Default Values: 3D4C (downlink TCH)
E149 (uplink TCH)
050EF2993 (downlink SYNC)
B899AF0 (uplink SYNC)

Softkey Location: **Mode > TDMA > PHS > Data Format Pattern Framed > Configure Timeslots > Configure TCH > UW**

UW is also located in the uplink Configure TCH menu and in the downlink and uplink Configure SYNC menus.

W

Window

Pressing this softkey accesses a menu for applying a windowing function to the selected filter. The default is to use no windowing which optimizes the passband response (EVM). Several windowing selections are provided in this menu which can be applied to smooth the filter's transition to zero. Windowing improves out of band performance (ACP) but simultaneously degrades EVM.

Default Value: None

Softkey Location: **Mode > TDMA > *desired format* > Modify Standard > Filter > Define User I/Q > Load Default FIR > Root Nyquist (or any other filter) > Window**

4 Programming Commands and Examples

This chapter describes Options UN8 and 202 SCPI commands and provides programming examples.

Descriptions of commands include syntax requirements, ranges, restrictions, query responses, and status at *RST.

When <desired format> is shown in a menu path, it means to choose the appropriate softkey for the communication standard that is being used. Unless indicated otherwise, <desired format> refers to the following standards:

- Custom
- DECT
- EDGE (Option 202)
- GSM
- NADC
- PDC
- PHS
- TETRA

Programming Commands

The following commands are listed in alphabetical order by subject.

A Field

DECT - Portable Part Low Capacity Timeslot

```
[ :SOURce]:RADio:DECT:PPart:SLOT0|[1]|2|3|4|5|6|7|8|9|10|11:LCAPacity:  
A <64-bit value>
```

```
[ :SOURce]:RADio:DECT:PPart:SLOT0|[1]|2|3|4|5|6|7|8|9|10|11:LCAPacity:A?
```

This command enables you to customize the A field for the selected low capacity timeslot in the portable part link. The A field carries signaling data (48 bits) and correction error (16 bits).

Range: 0000000000000000 to FFFFFFFF00000000 (hexadecimal)

*RST value: 0000FFFF0000FFFF (hexadecimal)

DECT - Portable Part Low Capacity with Z Field Timeslot

```
[ :SOURce]:RADio:DECT:PPart:SLOT0|[1]|2|3|4|5|6|7|8|9|10|11:ZLCapacity:  
A <64-bit value>
```

```
[ :SOURce]:RADio:DECT:PPart:SLOT0|[1]|2|3|4|5|6|7|8|9|10|11:ZLCapacity:A?
```

This command enables you to customize the A field for the selected low capacity with Z field timeslot in the portable part link. The A field carries signaling data (48 bits) and correction error (16 bits).

Range: 0000000000000000 to FFFFFFFF00000000 (hexadecimal)

*RST value: 0000FFFF0000FFFF (hexadecimal)

DECT - Portable Part Traffic Bearer Timeslot

```
[ :SOURce]:RADio:DECT:PPart:SLOT0|[1]|2|3|4|5|6|7|8|9|10|11:TRAFfic:  
A <64-bit value>
```

```
[ :SOURce]:RADio:DECT:PPart:SLOT0|[1]|2|3|4|5|6|7|8|9|10|11:TRAFfic:A?
```

This command enables you to customize the A field for the selected traffic bearer timeslot in the portable part link. The A field carries signaling data (48 bits) and correction error (16 bits).

Range: 0000000000000000 to FFFFFFFF00000000 (hexadecimal)

*RST value: 0000FFFF0000FFFF (hexadecimal)

DECT - Portable Part Traffic Bearer with Z Field Timeslot

```
[ :SOURce]:RADio:DECT:PPart:SLOT0|[1]|2|3|4|5|6|7|8|9|10|11:ZTRaffic:  
A <64-bit value>
```

```
[ :SOURce]:RADio:DECT:PPart:SLOT0|[1]|2|3|4|5|6|7|8|9|10|11:ZTRaffic:A?
```

This command enables you to customize the A field for the selected traffic bearer with Z field timeslot in the portable part link. The A field carries signaling data (48 bits) and correction error (16 bits).

Range: 0000000000000000 to FFFFFFFFFFFFFFFFFF (hexadecimal)

*RST value: 0000FFFF0000FFFF (hexadecimal)

DECT - Radio Fixed Part Dummy Timeslot

```
[ :SOURce]:RADio:DECT:RFPart:SLOT0|[1]|2|3|4|5|6|7|8|9|10|11:DUMM[1]|2:  
A <16-bit value>
```

```
[ :SOURce]:RADio:DECT:RFPart:SLOT0|[1]|2|3|4|5|6|7|8|9|10|11:DUMM[1]|2:A?
```

This command enables you to customize the A field for the selected dummy 1 or 2 timeslot in the radio fixed part link. The A field carries signaling data (48 bits) and correction error (16 bits).

Range: 0000000000000000 to FFFFFFFFFFFFFFFFFF (hexadecimal)

*RST value: 0000FFFF0000FFFF

DECT - Radio Fixed Part Low Capacity Timeslot

```
[ :SOURce]:RADio:DECT:RFPart:SLOT0|[1]|2|3|4|5|6|7|8|9|10|11:LCAPacity:  
A <64-bit value>
```

```
[ :SOURce]:RADio:DECT:RFPart:SLOT0|[1]|2|3|4|5|6|7|8|9|10|11:LCAPacity:A?
```

This command enables you to customize the A field for the selected low capacity timeslot in the radio fixed part link. The A field carries signaling data (48 bits) and correction error (16 bits).

Range: 0000000000000000 to FFFFFFFFFFFFFFFFFF (hexadecimal)

*RST value: 0000FFFF0000FFFF

DECT - Radio Fixed Part Low Capacity with Z Field Timeslot

```
[ :SOURce]:RADio:DECT:RFPart:SLOT0|[1]|2|3|4|5|6|7|8|9|10|11:ZLCapacity:  
A <64-bit value>
```

```
[ :SOURce]:RADio:DECT:RFPart:SLOT0|[1]|2|3|4|5|6|7|8|9|10|11:ZLCapacity:A?
```

This command enables you to customize the A field for the selected low capacity with Z field timeslot in the radio fixed part link. The A field carries signaling data (48 bits) and correction error (16 bits).

Range: 0000000000000000 to FFFFFFFFFFFFFFFFFF (hexadecimal)

*RST value: 0000FFFF0000FFFF

DECT - Radio Fixed Part Traffic Bearer Timeslot

```
[ :SOURce]:RADio:DECT:RFPart:SLOT0|[1]|2|3|4|5|6|7|8|9|10|11:TRAFfic:  
A <64-bit value>
```

```
[ :SOURce]:RADio:DECT:RFPart:SLOT0|[1]|2|3|4|5|6|7|8|9|10|11:TRAFfic:A?
```

This command enables you to customize the A field for the selected traffic bearer timeslot in the radio fixed part link. The A field carries signaling data (48 bits) and correction error (16 bits).

Range: 0000000000000000 to FFFFFFFF00000000 (hexadecimal)

*RST value: 0000FFFF0000FFFF (hexadecimal)

DECT - Radio Fixed Part Traffic Bearer with Z Field Timeslot

```
[ :SOURce]:RADio:DECT:RFPart:SLOT0|[1]|2|3|4|5|6|7|8|9|10|11:ZTRAffic:  
A <64-bit value>
```

```
[ :SOURce]:RADio:DECT:RFPart:SLOT0|[1]|2|3|4|5|6|7|8|9|10|11:ZTRAffic:A?
```

This command enables you to customize the A field for the selected traffic bearer timeslot in the radio fixed part link. The A field carries signaling data (48 bits) and correction error (16 bits).

Range: 0000000000000000 to FFFFFFFF00000000 (hexadecimal)

*RST value: 0000FFFF0000FFFF (hexadecimal)

B Field

DECT - Portable Part Low Capacity Timeslot

```
[ :SOURce]:RADio:DECT:PPart:SLOT0|[1]|2|3|4|5|6|7|8|9|10|11:LCAPacity[:B]  
PN9|PN15|FIX4|"<file name>"|EXT|FDEV1_HS|FDEV1_FS|FDEV2_FS|FACCuracy|  
DM1|DM0|P4|P8|P16|P32|P64
```

```
[ :SOURce]:RADio:DECT:PPart:SLOT0|[1]|2|3|4|5|6|7|8|9|10|11:LCAPacity[:B]?
```

This command sets a data pattern for the B field of the selected portable part low capacity timeslot. The choices are timeslots 0 through 11 and PN9 (pseudorandom bit pattern), PN15 (pseudorandom bit pattern), FIX4 (4-bit repeating sequence data pattern), "<file name>" (a file in the catalog of binary files), Ext (external-input data pattern), half-slot frequency deviation (8 bits of 10 followed by 32 ones, 32 zeros, and 8 bits of 10), full-slot frequency deviation #1 (128 bits of 10, followed by 64 ones, 64 zeros, and 64 bits of 10), full-slot frequency deviation #2 (the bits 10 repeated as necessary to fill the selected data area), frequency accuracy (the bits 11110000 repeated as necessary to fill the selected data area), DM1 (all 1's repeated as necessary to fill the selected data area), DM0 (all 0's repeated as necessary to fill the selected data area), P4 (four 1's and four 0's), P8 (eight 1's and eight 0's), P16 (sixteen 1's and sixteen 0's), P32 (thirty-two 1's and thirty-two 0's), or P64 (sixty-four 1's and sixty-four 0's).

*RST value: PN9

DECT - Portable Part Low Capacity with Z Field Timeslot

```
[ :SOURCE]:RADIO:DECT:PPart:SLOT0|[1]|2|3|4|5|6|7|8|9|10|11:
ZLCapacity[:B] PN9|PN15|FIX4|"<file name>"|EXT|FDEV1_HS|FDEV1_FS|FDEV2_FS|
FACCuracy| DM1|DM0|P4|P8|P16|P32|P64
```

```
[ :SOURCE]:RADIO:DECT:PPart:SLOT0|[1]|2|3|4|5|6|7|8|9|10|11:ZLCapacity[:B]?
```

This command sets a data pattern for the B field of the selected portable part low capacity with Z field timeslot. The choices are timeslots 0 through 11 and PN9 (pseudorandom bit pattern), PN15 (pseudorandom bit pattern), FIX4 (4-bit repeating sequence data pattern), "<file name>" (a file in the catalog of binary files), Ext (external-input data pattern), half-slot frequency deviation (8 bits of 10 followed by 32 ones, 32 zeros, and 8 bits of 10), full-slot frequency deviation #1 (128 bits of 10, followed by 64 ones, 64 zeros, and 64 bits of 10), full-slot frequency deviation #2 (the bits 10 repeated as necessary to fill the selected data area), frequency accuracy (the bits 11110000 repeated as necessary to fill the selected data area), DM1 (all 1's repeated as necessary to fill the selected data area), DM0 (all 0's repeated as necessary to fill the selected data area), P4 (four 1's and four 0's), P8 (eight 1's and eight 0's), P16 (sixteen 1's and sixteen 0's), P32 (thirty-two 1's and thirty-two 0's), or P64 (sixty-four 1's and sixty-four 0's).

*RST value: PN9

DECT - Portable Part Traffic Bearer Timeslot

```
[ :SOURCE]:RADIO:DECT:PPart:SLOT0|[1]|2|3|4|5|6|7|8|9|10|
11:TRAFFIC[:B] PN9|PN15|FIX4|"<file name>"|EXT|FDEV1_HS|FDEV1_FS|FDEV2_FS|
FACCuracy|DM1| DM0|P4|P8|P16|P32|P64
```

```
[ :SOURCE]:RADIO:DECT:PPart:SLOT0|[1]|2|3|4|5|6|7|8|9|10|11:TRAFFIC[:B]?
```

This command sets the B field data pattern for the selected traffic bearer timeslot in the portable part link. The choices are timeslots 0 through 11 and PN9 (pseudorandom bit pattern), PN15 (pseudorandom bit pattern), FIX4 (4-bit repeating sequence data pattern), "<file name>" (a file in the catalog of binary files), Ext (external-input data pattern), half-slot frequency deviation (8 bits of 10 followed by 32 ones, 32 zeros, and 8 bits of 10), full-slot frequency deviation #1 (128 bits of 10, followed by 64 ones, 64 zeros, and 64 bits of 10), full-slot frequency deviation #2 (the bits 10 repeated as necessary to fill the selected data area), frequency accuracy (the bits 11110000 repeated as necessary to fill the selected data area), DM1 (all 1's repeated as necessary to fill the selected data area), DM0 (all 0's repeated as necessary to fill the selected data area), P4 (four 1's and four 0's), P8 (eight 1's and eight 0's), P16 (sixteen 1's and sixteen 0's), P32 (thirty-two 1's and thirty-two 0's), or P64 (sixty-four 1's and sixty-four 0's).

*RST value: PN9

DECT - Portable Part Traffic Bearer with Z Field Timeslot

```
[ :SOURce]:RADio:DECT:PPart:SLOT0|[1]|2|3|4|5|6|7|8|9|10|  
11:ZTRaffic[:B] PN9|PN15|FIX4|"<file name>"|EXT|FDEV1_HS|FDEV1_FS|  
FDEV2_FS|FACCuracy|DM1| DM0|P4|P8|P16|P32|P64  
[ :SOURce]:RADio:DECT:PPart:SLOT0|[1]|2|3|4|5|6|7|8|9|10|11:ZTRaffic[:B]?
```

This command sets the B field data pattern for the selected traffic bearer with Z field timeslot in the portable part link. The choices are timeslots 0 through 11 and PN9 (pseudorandom bit pattern), PN15 (pseudorandom bit pattern), FIX4 (4-bit repeating sequence data pattern), "<file name>" (a file in the catalog of binary files), Ext (external-input data pattern), half-slot frequency deviation (8 bits of 10 followed by 32 ones, 32 zeros, and 8 bits of 10), full-slot frequency deviation #1 (128 bits of 10, followed by 64 ones, 64 zeros, and 64 bits of 10), full-slot frequency deviation #2 (the bits 10 repeated as necessary to fill the selected data area), frequency accuracy (the bits 11110000 repeated as necessary to fill the selected data area), DM1 (all 1's repeated as necessary to fill the selected data area), DM0 (all 0's repeated as necessary to fill the selected data area), P4 (four 1's and four 0's), P8 (eight 1's and eight 0's), P16 (sixteen 1's and sixteen 0's), P32 (thirty-two 1's and thirty-two 0's), or P64 (sixty-four 1's and sixty-four 0's).

*RST value: PN9

DECT - Radio Fixed Part Low Capacity Timeslot

```
[ :SOURce]:RADio:DECT:RFPart:SLOT0|[1]|2|3|4|5|6|7|8|9|10|  
11:LCAPacity[:B] PN9|PN15|FIX4|"<file name>"|EXT|FDEV1_HS|FDEV1_FS|  
FDEV2_FS|FACCuracy| DM1|DM0|P4|P8|P16|P32|P64  
[ :SOURce]:RADio:DECT:RFPart:SLOT0|[1]|2|3|4|5|6|7|8|9|10|11:LCAPacity[:B]?
```

This command enables you to set the B field's data pattern for the selected low capacity timeslot in the radio fixed part during framed data transmission. The choices are timeslots 0 through 11 and PN9 (pseudorandom bit pattern), PN15 (pseudorandom bit pattern), FIX4 (4-bit repeating sequence data pattern), "<file name>" (a file in the catalog of binary files), Ext (external input data pattern), half-slot frequency deviation (8 bits of 10 followed by 32 ones, 32 zeros, and 8 bits of 10), full-slot frequency deviation #1 (128 bits of 10, followed by 64 ones, 64 zeros, and 64 bits of 10), full-slot frequency deviation #2 (the bits 10 repeated as necessary to fill the selected data area), frequency accuracy (the bits 11110000 repeated as necessary to fill the selected data area), DM1 (all 1's repeated as necessary to fill the selected data area), DM0 (all 0's repeated as necessary to fill the selected data area), P4 (four 1's and four 0's), P8 (eight 1's and eight 0's), P16 (sixteen 1's and sixteen 0's), P32 (thirty-two 1's and thirty-two 0's), or P64 (sixty-four 1's and sixty-four 0's).

*RST value: PN9

DECT - Radio Fixed Part Low Capacity with Z Field Timeslot

```
[ :SOURce]:RADio:DECT:RFPart:SLOT0|[1]|2|3|4|5|6|7|8|9|10|
11:ZLCapacity[:B] PN9|PN15|FIX4|"<file name>"|EXT|FDEV1_HS|FDEV1_FS|
FDEV2_FS|FACCuracy| DM1|DM0|P4|P8|P16|P32|P64

[:SOURce]:RADio:DECT:RFPart:SLOT0|[1]|2|3|4|5|6|7|8|9|10|11:ZLCapacity
[:B]?
```

This command enables you to set the B field's data pattern for the selected low capacity with Z field timeslot in the radio fixed part during framed data transmission. The choices are timeslots 0 through 11 and PN9 (pseudorandom bit pattern), PN15 (pseudorandom bit pattern), FIX4 (4-bit repeating sequence data pattern), "<file name>" (a file in the catalog of binary files), Ext (external input data pattern), half-slot frequency deviation (8 bits of 10 followed by 32 ones, 32 zeros, and 8 bits of 10), full-slot frequency deviation #1 (128 bits of 10, followed by 64 ones, 64 zeros, and 64 bits of 10), full-slot frequency deviation #2 (the bits 10 repeated as necessary to fill the selected data area), frequency accuracy (the bits 11110000 repeated as necessary to fill the selected data area), DM1 (all 1's repeated as necessary to fill the selected data area), DM0 (all 0's repeated as necessary to fill the selected data area), P4 (four 1's and four 0's), P8 (eight 1's and eight 0's), P16 (sixteen 1's and sixteen 0's), P32 (thirty-two 1's and thirty-two 0's), or P64 (sixty-four 1's and sixty-four 0's).

*RST value: PN9

DECT - Radio Fixed Part Traffic Bearer Timeslot

```
[ :SOURce]:RADio:DECT:RFPart:SLOT0|[1]|2|3|4|5|6|7|8|9|10|
11:TRAFfic[:B] PN9|PN15|FIX4|"<file name>"|EXT|FDEV1_HS|FDEV1_FS|
FDEV2_FS|FACCuracy|DM1| DM0|P4|P8|P16|P32|P64

[:SOURce]:RADio:DECT:RFPart:SLOT0|[1]|2|3|4|5|6|7|8|9|10|11:TRAFfic[:B]?
```

This command enables you to set the B field's data pattern for the selected traffic bearer timeslot in the radio fixed part during framed data transmission. The choices are timeslots 0 through 11 and PN9 (pseudorandom bit pattern), PN15 (pseudorandom bit pattern), FIX4 (4-bit repeating sequence data pattern), "<file name>" (a file in the catalog of binary files), Ext (external input data pattern), half-slot frequency deviation (8 bits of 10 followed by 32 ones, 32 zeros, and 8 bits of 10), full-slot frequency deviation #1 (128 bits of 10, followed by 64 ones, 64 zeros, and 64 bits of 10), full-slot frequency deviation #2 (the bits 10 repeated as necessary to fill the selected data area), frequency accuracy (the bits 11110000 repeated as necessary to fill the selected data area), DM1 (all 1's repeated as necessary to fill the selected data area), DM0 (all 0's repeated as necessary to fill the selected data area), P4 (four 1's and four 0's), P8 (eight 1's and eight 0's), P16 (sixteen 1's and sixteen 0's), P32 (thirty-two 1's and thirty-two 0's), or P64 (sixty-four 1's and sixty-four 0's).

*RST value: PN9

DECT - Radio Fixed Part Traffic Bearer with Z Field Timeslot

```
[ :SOURCE]:RADIO:DECT:RFPart:SLOT0|[1]|2|3|4|5|6|7|8|9|10|  
11:ZTRaffic[:B] PN9|PN15|FIX4|"<file name>"|EXT|FDEV1_HS|FDEV1_FS|  
FDEV2_FS|FACCuracy|DM1| DM0|P4|P8|P16|P32|P64
```

```
[ :SOURCE]:RADIO:DECT:RFPart:SLOT0|[1]|2|3|4|5|6|7|8|9|10|11:ZTRaffic[:B]?
```

This command enables you to set the B field's data pattern for the selected traffic bearer with Z field timeslot in the radio fixed part during framed data transmission. The choices are timeslots 0 through 11 and PN9 (pseudorandom bit pattern), PN15 (pseudorandom bit pattern), FIX4 (4-bit repeating sequence data pattern), "<file name>" (a file in the catalog of binary files), Ext (external input data pattern), half-slot frequency deviation (8 bits of 10 followed by 32 ones, 32 zeros, and 8 bits of 10), full-slot frequency deviation #1 (128 bits of 10, followed by 64 ones, 64 zeros, and 64 bits of 10), full-slot frequency deviation #2 (the bits 10 repeated as necessary to fill the selected data area), frequency accuracy (the bits 11110000 repeated as necessary to fill the selected data area), DM1 (all 1's repeated as necessary to fill the selected data area), DM0 (all 0's repeated as necessary to fill the selected data area), P4 (four 1's and four 0's), P8 (eight 1's and eight 0's), P16 (sixteen 1's and sixteen 0's), P32 (thirty-two 1's and thirty-two 0's), or P64 (sixty-four 1's and sixty-four 0's).

*RST value: PN9

Broadcast Bit Field

TETRA - Downlink Continuous Synchronization Timeslot

```
[ :SOURCE]:RADIO:TETRA:SLOT[1]|2|3|4:DCSync:B <30-bit value>  
[ :SOURCE]:RADIO:TETRA:SLOT[1]|2|3|4:DCSync:B?
```

This command sets the broadcast bits for the selected downlink continuous synchronization timeslot.

*RST value: 00000000 (hexadecimal)

TETRA - Downlink Discontinuous Synchronization Timeslot

```
[ :SOURCE]:RADIO:TETRA:SLOT[1]|2|3|4:DDSync:B <30-bit value>  
[ :SOURCE]:RADIO:TETRA:SLOT[1]|2|3|4:DDSync:B?
```

This command sets the broadcast bits for the selected downlink discontinuous synchronization timeslot.

*RST value: 00000000 (hexadecimal)

Burst Configuration - State, Type, Rise/Fall Time, Rise/Fall Delay, PN9 Mode

Burst State

```
[ :SOURce]:RADio:<desired format>:BURSt[:STATe] ON|OFF|1|0  
[:SOURce]:RADio:<desired format>:BURSt[:STATe]?
```

This command enables and disables the burst function. The choices are On (1) or Off (0). Activating the burst transmits framed data. This means that you will be bursting the timeslots that are on and there will be no RF carrier during the off timeslots.

NOTE This is true for all up traffic channels and for custom timeslots. However, if you have switched on any timeslot that you have configured as a down traffic channel, the RF signal is *not* switched off between timeslots and the off timeslots are transmitted as a continuous series of ones for the time period of the off timeslots. Switching the burst state off allows modulation of pseudo-random sequences, user files, 4-bit patterns, or clocked data.

*RST value: Off

Burst Shape Type

```
[ :SOURce]:RADio:CUSTOm:BURSt:SHAPE[:TYPE] SINE|"<file name>"  
[:SOURce]:RADio:CUSTOm:BURSt:SHAPE[:TYPE]?  
[:SOURce]:RADio:<desired format>:BURSt:SHAPE[:TYPE] SINE|"<file name>"  
[:SOURce]:RADio:<desired format>:BURSt:SHAPE[:TYPE]?
```

This command lets you specify the burst shape as either *SINE* or a user-defined file ("*<file name>*"). User files must first be downloaded into signal generator memory before they can be selected.

*RST value: Sine

Burst Shape Files, Creating

```
:MEMory:DATA:SHAPE "<file name>",num_rise_points,rp0,  
rp1,...num_fall_points,fp0,fp1,...
```

This command creates a new burst shape file with the following components:

"<file name>" Identifies the name of the burst shape file.

num_rise_points Specifies how many rise points will follow. The range allowed is 2 through 256.

rp0,rp1,... Defines each successive rise point. Set each point from 0.0 through 1.0, where 0 is no power and 1 is full power.

num_fall_points Specifies how many fall points will follow. The range allowed is 2 through 256.

fp0,fp1,... Defines each successive fall point. Set each point from 0.0 through 1.0, where 0 is no power and 1 is full power.

```
:MEMory:DATA:SHAPE? "<file name>"
```

This command outputs the contents of the specified burst shape file.

```
:MEMory:CATalog:SHAPE?
```

This command outputs a catalog of the burst shape files stored in memory.

```
:MEMory:DELeTe:SHAPE
```

This command deletes all burst shape files stored in memory.

Burst Fall Delay

```
[ :SOURce]:RADio:CUSTom:BURSt:SHAPE:FALL:DELAy <value>
```

```
[ :SOURce]:RADio:CUSTom:BURSt:SHAPE:FALL:DELAy?
```

```
[ :SOURce]:RADio:CUSTom:BURSt:SHAPE:FDELAy <value>
```

```
[ :SOURce]:RADio:CUSTom:BURSt:SHAPE:FDELAy?
```

```
[ :SOURce]:RADio:<desired format>:BURSt:SHAPE:FALL:DELAy <value>
```

```
[ :SOURce]:RADio:<desired format>:BURSt:SHAPE:FALL:DELAy?
```

```
[ :SOURce]:RADio:<desired format>:BURSt:SHAPE:FDELAy <value>
```

```
[ :SOURce]:RADio:<desired format>:BURSt:SHAPE:FDELAy?
```

This command sets the burst shape fall delay.

Range: minimum and maximum values depend upon modulation type and symbol rate.

*RST value:

- Custom: 0.000
- DECT: -2.875 bits
- EDGE: 1.200 bits
- GSM: 0.125 bits
- NADC: -1.000 bits
- PDC: -0.500 bits
- PHS: -1.500 bits
- TETRA: 0.000 bits

Burst Fall Time

```
[ :SOURce]:RADio:CUSTom:BURSt:SHAPE:FALL:TIME <value>  
[ :SOURce]:RADio:CUSTom:BURSt:SHAPE:FALL:TIME?  
[ :SOURce]:RADio:CUSTom:BURSt:SHAPE:F'TIME <value>  
[ :SOURce]:RADio:CUSTom:BURSt:SHAPE:F'TIME?  
  
[ :SOURce]:RADio:<desired format>:BURSt:SHAPE:FALL:TIME <value>  
[ :SOURce]:RADio:<desired format>:BURSt:SHAPE:FALL:TIME?  
[ :SOURce]:RADio:<desired format>:BURSt:SHAPE:F'TIME <value>  
[ :SOURce]:RADio:<desired format>:BURSt:SHAPE:F'TIME?
```

This command sets the burst shape fall time.

Range: minimum and maximum values depend upon modulation type and symbol rate.

*RST value:

- Custom: 5.470
- DECT: 11.529 bits
- EDGE: 10.300 bits
- GSM: 3.440 bits
- NADC: 5.470 bits
- PDC: 3.830 bits
- PHS: 4.544 bits
- TETRA: 7.814 bits

Burst Rise Delay

```
[ :SOURce]:RADio:CUSTom:BURSt:SHAPE:RDElay <value>  
[ :SOURce]:RADio:CUSTom:BURSt:SHAPE:RDElay?  
[ :SOURce]:RADio:CUSTom:BURSt:SHAPE:RISE:DElay <value>  
[ :SOURce]:RADio:CUSTom:BURSt:SHAPE:RISE:DElay?  
  
[ :SOURce]:RADio:<desired format>:BURSt:SHAPE:RISE:DElay <value>  
[ :SOURce]:RADio:<desired format>:BURSt:SHAPE:RISE:DElay?  
[ :SOURce]:RADio:<desired format>:BURSt:SHAPE:RDElay <value>  
[ :SOURce]:RADio:<desired format>:BURSt:SHAPE:RDElay?
```

This command sets the burst shape rise delay.

Range: minimum and maximum values depend upon modulation type and symbol rate.

*RST value:

- Custom: 0.000
- DECT: -3.250 bits
- EDGE: 4.400 bits
- GSM: 0.000 bits
- NADC: -1.000 bits
- PDC: 0.000 bits
- PHS: -1.500 bits
- TETRA: -1.000 bits

Burst Rise Time

```
[ :SOURce]:RADio:CUSTom:BURSt:SHAPE:RISE:TIME <value>
[ :SOURce]:RADio:CUSTom:BURSt:SHAPE:RISE:TIME?
[ :SOURce]:RADio:CUSTom:BURSt:SHAPE:RTIME <value>
[ :SOURce]:RADio:CUSTom:BURSt:SHAPE:RTIME?

[ :SOURce]:RADio:<desired format>:BURSt:SHAPE:RISE:TIME <value>
[ :SOURce]:RADio:<desired format>:BURSt:SHAPE:RISE:TIME?
[ :SOURce]:RADio:<desired format>:BURSt:SHAPE:RTIME <value>
[ :SOURce]:RADio:<desired format>:BURSt:SHAPE:RTIME?
```

This command sets the burst shape rise time.

Range: minimum and maximum values depend upon modulation type and symbol rate.

*RST value:

- Custom: 5.860
- DECT: 13.797 bits
- EDGE: 12.700 bits
- GSM: 4.224 bits
- NADC: 5.860 bits
- PDC: 5.470 bits
- PHS: 4.976 bits
- TETRA: 9.376 bits

PN9 Mode

```
[ :SOURce]:RADio:<desired format>1:BURSt:PN9 NORMAl|QUICK
[ :SOURce]:RADio:<desired format>1:BURSt:PN9?
```

¹All formats except EDGE.

This command controls the software PN9 generation. Normal mode produces a maximal length PN9 sequence. Quick mode produces a truncated PN9 sequence. Use Normal mode for bit-error-rate tests where a maximal length PN9 sequence is required.

*RST value: Normal

Cell Station Identification Code (CSID) Field

```
[SOURce]:RADio:PHS:DLINK:SLOT[1]|2|3|4:SCHannel:CSID <bit pattern>
[SOURce]:RADio:PHS:DLINK:SLOT[1]|2|3|4:SCHannel:CSID?

[SOURce]:RADio:PHS:ULINK:SLOT[1]|2|3|4:SCHannel:CSID <bit pattern>
[SOURce]:RADio:PHS:ULINK:SLOT[1]|2|3|4:SCHannel:CSID?
```

This command enables you to change the 42-bit cell station identification code (CSID) field. The preset hexadecimal value (when normal preset is selected) for CSID reflects the PHS protocol, however you can enter a new value with this command. The current value for CSID is displayed in the CSID field near the bottom of the text area of the display.

Range: 00000000000 to 3FFFFFFF (hexadecimal)

*RST value: 20200020001

Coded Digital Channel Locator (CDL) Field

```
[SOURCE]:RADIO[:NADC]:SLOT[1]|2|3|4|5|6:DTCHannel:  
CDLocator <11-bit pattern>  
[SOURCE]:RADIO[:NADC]:SLOT[1]|2|3|4|5|6:DTCHannel:CDLocator?
```

This command enables you to change the 11-bit coded digital control channel locator (CDL) field. The preset hexadecimal value (when normal preset is selected) for CDL reflects the NADC protocol, however you can enter a new value by using this command.

Range: 000 to 7FF (hexadecimal)

*RST value: 000 (hexadecimal)

Coded Digital Verification Color Code (CDVCC) Field

```
[SOURCE]:RADIO[:NADC]:SLOT[1]|2|3|4|5|6:DTCHannel:  
CDVCCcode <12-bit pattern>  
[SOURCE]:RADIO[:NADC]:SLOT[1]|2|3|4|5|6:DTCHannel:CDVCCcode?  
[SOURCE]:RADIO[:NADC]:SLOT[1]|2|3|4|5|6:UTCHannel:  
CDVCCcode <12-bit pattern>  
[SOURCE]:RADIO[:NADC]:SLOT[1]|2|3|4|5|6:UTCHannel:CDVCCcode?
```

This command enables you to change the 12-bit coded digital verification color code (CDVCC). The preset hexadecimal value (when normal preset is selected) for CDVCC reflects the NADC protocol, however you can enter a new value by using this command.

Range: 000 to FFF (hexadecimal)

*RST value: 000 (hexadecimal)

Color Code Field

```
[ :SOURCE]:RADIO:PDC:SLOT0|[1]|2|3|4|5:DTCHannel:CCODE <bit pattern>  
[ :SOURCE]:RADIO:PDC:SLOT0|[1]|2|3|4|5:DTCHannel:CCODE?  
  
[ :SOURCE]:RADIO:PDC:SLOT0|[1]|2|3|4|5:UTCHannel:CCODE <bit pattern>  
[ :SOURCE]:RADIO:PDC:SLOT0|[1]|2|3|4|5:UTCHannel:CCODE?  
  
[ :SOURCE]:RADIO:PDC:SLOT0|[1]|2|3|4|5:UVOX:CCODE <bit pattern>  
[ :SOURCE]:RADIO:PDC:SLOT0|[1]|2|3|4|5:UVOX:CCODE?
```

This command enables you to change the 8-bit color code (CC). The preset hexadecimal value (when normal preset is selected) for CC reflects the PDC protocol, however you can enter a new value using this command. The current value for CC is displayed in the CC field near the bottom line of the text area of the display.

Range: 00 to FF (hexadecimal)

*RST value: 00

Data Clock Input Configuration

```
[ :SOURce]:RADio:CUSTom:BBCLock INT[1]|EXT[1]
[ :SOURce]:RADio:CUSTom:BBCLock?

[ :SOURce]:RADio:<desired format>:BBCLock INT[1]|EXT[1]
[ :SOURce]:RADio:<desired format>:BBCLock?
```

This command sets the data (bit) clock input to the baseband generator board to either Internal or External. This command is independent in each mode and works for both non-burst (continuous) and burst modes. This allows for a matrix of selections between burst/non-burst, internal/external data generation, internal/external data clock, and external bit/symbol data clock. A data clock or symbol sync input must be supplied when external mode is used.

INT[1] Selects the instrument's internal data clock.

EXT[1] Selects an external data clock input.

*RST value: Internal

Data Selection for Framed Transmissions

DECT - Portable Part Custom Timeslot

```
[ :SOURce]:RADio:DECT:PPart:SLOT0|[1]|2|3|4|5|6|7|8|9|10|
11:CUSTom PN9|PN15|FIX4|"<file name>"|EXT|FDEV1_HS|FDEV1_FS|
FDEV2_FS|FACCuracy|DM1| DM0|P4|P8|P16|P32|P64

[ :SOURce]:RADio:DECT:PPart:SLOT0|[1]|2|3|4|5|6|7|8|9|10|11:CUSTom?
```

This command enables you to customize the selected custom timeslot for a portable part link. The choices are timeslots 0 through 11 and PN9 (pseudorandom bit pattern), PN15 (pseudorandom bit pattern), FIX4 (4-bit repeating sequence data pattern), "<file name>" (a file in the catalog of binary files), Ext (external-input data pattern), half-slot frequency deviation (repetitive pattern of 1, 0, 1, 0... followed by 32 ones, 32 zeroes, and 8 bits: repetitive pattern of 1, 0, 1, 0...), full-slot frequency deviation #1 (repetitive pattern of 1, 0, 1, 0... followed by 64 ones, 64 zeroes, and 64 bits: repetitive pattern of 1, 0, 1, 0...), full-slot frequency deviation #2 (repetitive pattern of 1, 0, 1, 0... followed by 64 ones, 64 zeroes, and 64 bits: repetitive pattern of 1, 0, 1, 0...), frequency accuracy (the bits 11110000 repeated as necessary to fill the selected data area), DM1 (all 1's repeated as necessary to fill the selected data area), DM0 (all 0's repeated as necessary to fill the selected data area), P4 (four 1's and four 0's), P8 (eight 1's and eight 0's), P16 (sixteen 1's and sixteen 0's), P32 (thirty-two 1's and thirty-two 0's), or P64 (sixty-four 1's and sixty-four 0's).

*RST value: PN9

DECT - Radio Fixed Part Custom Timeslot

```
[ :SOURce]:RADio:DECT:RFPart:SLOT0|[1]|2|3|4|5|6|7|8|9|10|
11:CUSTom PN9|PN15|FIX4| "<file name>" |EXT|FDEV1_HS|FDEV1_FS|FDEV2_FS|
FACCuracy|DM1|DM0|P4|P8|P16|P32|P64
```

```
[ :SOURce]:RADio:DECT:RFPart:SLOT0|[1]|2|3|4|5|6|7|8|9|10|11:CUSTom?
```

This command enables you to set the data pattern for the data field of the selected custom timeslot in the radio fixed part link. The choices are timeslots 0 through 11 and PN9 (pseudorandom bit pattern), PN15 (pseudorandom bit pattern), FIX4 (4-bit repeating sequence data pattern), "<file name>" (a file in the catalog of binary files), Ext (external input data pattern), half-slot frequency deviation (8 bits of 10 followed by 32 ones, 32 zeros, and 8 bits of 10), full-slot frequency deviation #1 (128 bits of 10, followed by 64 ones, 64 zeros, and 64 bits of 10), full-slot frequency deviation #2 (the bits 10 repeated as necessary to fill the selected data area), frequency accuracy (the bits 11110000 repeated as necessary to fill the selected data area), DM1 (all 1's repeated as necessary to fill the selected data area), DM0 (all 0's repeated as necessary to fill the selected data area), P4 (four 1's and four 0's), P8 (eight 1's and eight 0's), P16 (sixteen 1's and sixteen 0's), P32 (thirty-two 1's and thirty-two 0's), or P64 (sixty-four 1's and sixty-four 0's).

*RST value: PN9

EDGE - Custom Timeslot

```
[ :SOURce]:RADio:EDGE:SLOT0|[1]|2|3|4|5|6|7:CUSTom PN9|PN15|FIX4|
"<file name>"|EXT|P4|P8|P16|P32|P64
[:SOURce]:RADio:EDGE:SLOT0|[1]|2|3|4|5|6|7:CUSTom?
```

This command enables you to configure the data field for the selected custom timeslot. The choices are timeslots 0 through 7 and the following:

PN9	9-bit pseudorandom pattern
PN15	15-bit pseudorandom pattern
FIX4	4-bit repeating sequence data pattern
"<file name>"	A file in the catalog of binary files
Ext	External input data pattern
P4	Four 1's and four 0's
P8	Eight 1's and eight 0's
P16	Sixteen 1's and sixteen 0's
P32	Thirty-two 1's and thirty-two 0's
P64	Sixty-four 1's and sixty-four 0's

*RST value: PN9

EDGE - Normal Timeslot Encryption Data Field

```
[ :SOURCE]:RADIo:EDGE:SLOT0 | [1] | 2 | 3 | 4 | 5 | 6 | 7:NORMAl:ENCRyption PN9 | PN15 |  
FIX4 | "<file name>" | EXT | P4 | P8 | P16 | P32 | P64 | DMCS9 | UMCS9 | DMCS5 |  
UMCS5 | ETCHF43 | UNCodeD  
[ :SOURCE]:RADIo:EDGE:SLOT0 | [1] | 2 | 3 | 4 | 5 | 6 | 7:NORMAl:ENCRyption?
```

This command enables you to configure the encryption data field for the selected normal timeslot. The choices are timeslots 0 through 7 and PN9 (pseudorandom bit pattern), PN15 (pseudorandom bit pattern), FIX4 (4-bit repeating sequence data pattern), "<file name>" (a file in the catalog of binary files), or External (external input data pattern via the DATA INPUT connector), P4 (four 1's and four 0's), P8 (eight 1's and eight 0's), P16 (sixteen 1's and sixteen 0's), P32 (thirty-two 1's and thirty-two 0's), or P64 (sixty-four 1's and sixty-four 0's).

*RST value: PN9

EDGE-Downlink Normal Timeslot Encryption Data Field

```
[ :SOURCE]:RADIo:EDGE:SLOT0 | [1] | 2 | 3 | 4 | 5 | 6 | 7:NORMAl:ENCRyption:DLINk:MCS5:  
DATA {PN9} | PN15  
[ :SOURCE]:RADIo:EDGE:SLOT0 | [1] | 2 | 3 | 4 | 5 | 6 | 7:NORMAl:ENCRyption:DLINk:MCS5:  
DATA?  
[ :SOURCE]:RADIo:EDGE:SLOT0 | [1] | 2 | 3 | 4 | 5 | 6 | 7:NORMAl:ENCRyption:DLINk:MCS9:  
DATA {PN9} | PN15  
[ :SOURCE]:RADIo:EDGE:SLOT0 | [1] | 2 | 3 | 4 | 5 | 6 | 7:NORMAl:ENCRyption:DLINk:MCS9:  
DATA?
```

This command enables you to create and configure a downlink encrypted data field for a normal timeslot.

*RST value: PN9

EDGE-ETCH Normal Timeslot Encryption Data Field

```
[ :SOURCE]:RADIo:EDGE:SLOT0 | [1] | 2 | 3 | 4 | 5 | 6 | 7:NORMAl:ENCRyption:ETCH:F43:  
DATA {PN9} | PN15  
[ :SOURCE]:RADIo:EDGE:SLOT0 | [1] | 2 | 3 | 4 | 5 | 6 | 7:NORMAl:ENCRyption:ETCH:F43:  
DATA?
```

This command enables you to create and configure an enhanced circuit switched full rate encryption data field for a normal timeslot.

*RST value: PN9

EDGE-Uncoded Normal Timeslot Encryption Data Field

```
[ :SOURCE]:RADIo:EDGE:SLOT0 | [1] | 2 | 3 | 4 | 5 | 6 | 7:NORMAl:ENCRyption:  
UNCodeD PN9 | PN15  
[ :SOURCE]:RADIo:EDGE:SLOT0 | [1] | 2 | 3 | 4 | 5 | 6 | 7:NORMAl:ENCRyption:UNCodeD?
```

This command enables you to create and configure an uncoded encryption data field for a normal timeslot. T

*RST value: PN9

EDGE-Uplink Normal Timeslot Encryption Data Field

```
[ :SOURCE]:RADIO:EDGE:SLOT0|[1]|2|3|4|5|6|7:NORMAL:ENCRYPTION:ULINK:MCS5:
DATA {PN9}|PN15
```

```
[ :SOURCE]:RADIO:EDGE:SLOT0|[1]|2|3|4|5|6|7:NORMAL:ENCRYPTION:ULINK:MCS5:
DATA?
```

```
[ :SOURCE]:RADIO:EDGE:SLOT0|[1]|2|3|4|5|6|7:NORMAL:ENCRYPTION:ULINK:MCS9:
DATA {PN9}|PN15
```

```
[ :SOURCE]:RADIO:EDGE:SLOT0|[1]|2|3|4|5|6|7:NORMAL:ENCRYPTION:ULINK:MCS9:
DATA?
```

This command enables you to create and configure an uplink encrypted data field for a normal timeslot.

*RST value: PN9

GSM - Access Timeslot Encryption Data Field

```
[ :SOURCE]:RADIO:GSM:SLOT0|[1]|2|3|4|5|6|7:ACCESS:ENCRYPTION PN9|
PN15|FIX4|"<file name>"|EXT|P4|P8|P16|P32|P64
```

```
[ :SOURCE]:RADIO:GSM:SLOT0|[1]|2|3|4|5|6|7:ACCESS:ENCRYPTION?
```

This command enables you to create and configure an access encrypted data field. The choices are timeslots 0 through 7 and PN9 (pseudorandom bit pattern), PN15 (pseudorandom bit pattern), FIX4 (4-bit repeating sequence data pattern), "<file name>" (a file in the catalog of binary files), Ext (external input data pattern), P4 (four 1's and four 0's), P8 (eight 1's and eight 0's), P16 (sixteen 1's and sixteen 0's), P32 (thirty-two 1's and thirty-two 0's), or P64 (sixty-four 1's and sixty-four 0's).

*RST value: PN9

GSM - Custom Timeslot

```
[ :SOURCE]:RADIO:GSM:SLOT0|[1]|2|3|4|5|6|7:CUSTOM PN9|PN15|FIX4|
"<file name>"|EXT|P4|P8|P16|P32|P64
```

```
[ :SOURCE]:RADIO:GSM:SLOT0|[1]|2|3|4|5|6|7:CUSTOM?
```

This command enables you to configure the data field for the selected custom timeslot. The choices are timeslots 0 through 7 and the following:

PN9	Pseudorandom bit pattern
PN15	Pseudorandom bit pattern
FIX4	4-bit repeating sequence data pattern
"<file name>"	A file in the catalog of binary files
Ext	External input data pattern
P4	Four 1's and four 0's
P8	Eight 1's and eight 0's
P16	Sixteen 1's and sixteen 0's

P32 Thirty-two 1's and thirty-two 0's

P64 Sixty-four 1's and sixty-four 0's

*RST value: PN9

GSM - Normal Timeslot Encryption Data Field

```
[ :SOURce]:RADio:GSM:SLOT0|[1]|2|3|4|5|6|7:NORMAl:ENCRyption  
PN9|PN15|FIX4|"<file name>"|EXT|P4|P8|P16|P32|P64|MPN9|MPN15  
[ :SOURce]:RADio:GSM:SLOT0|[1]|2|3|4|5|6|7:NORMAl:ENCRyption?
```

This command enables you to create and configure an encrypted data field for a normal timeslot. The choices are timeslots 0 through 7 and PN9 (pseudorandom bit pattern), PN15 (pseudorandom bit pattern), FIX4 (4-bit repeating sequence data pattern), "<file name>" (a file in the catalog of binary files), Ext (external input data pattern), P4 (four 1's and four 0's), P8 (eight 1's and eight 0's), P16 (sixteen 1's and sixteen 0's), P32 (thirty-two 1's and thirty-two 0's), P64 (sixty-four 1's and sixty-four 0's), MPN9 (inserts a PN9 sequence into a multiframe slot), or MPN15 (inserts a PN15 sequence into a multiframe slot).

*RST value: PN9

GSM - CS1 Normal Timeslot Encryption Data Field

```
[ :SOURce]:RADio:GSM:SLOT0|[1]|2|3|4|5|6|7:NORMAl:ENCRyption:CS1:  
DATA PN9|PN15  
[ :SOURce]:RADio:GSM:SLOT0|[1]|2|3|4|5|6|7:NORMAl:ENCRyption:CS1:DATA?
```

This command enables you to create and configure a block type 1 encrypted data field for a normal timeslot.

*RST value: PN9

GSM - Downlink Normal Timeslot Encryption Data Field

```
[ :SOURce]:RADio:GSM:SLOT0|[1]|2|3|4|5|6|7:NORMAl:ENCRyption:DLINK:MCS1:  
DATA PN9|PN15  
[ :SOURce]:RADio:GSM:SLOT0|[1]|2|3|4|5|6|7:NORMAl:ENCRyption:DLINK:MCS1:  
DATA?
```

This command enables you to create and configure a downlink block type 5 encrypted data field for a normal timeslot.

*RST value: PN9

GSM - TCH/FS Normal Timeslot Encryption Data Field

```
[ :SOURce]:RADio:GSM:SLOT0|[1]|2|3|4|5|6|7:NORMAl:ENCRyption:TCH:FS:  
DATA PN9|PN15  
[ :SOURce]:RADio:GSM:SLOT0|[1]|2|3|4|5|6|7:NORMAl:ENCRyption:TCH:FS:DATA?
```

This command enables you to create and configure a full rate speech encrypted data field for a normal timeslot.

*RST value: PN9

GSM - Uplink Normal Timeslot Encryption Data Field

```
[ :SOURCE]:RADIO:GSM:SLOT0|[1]|2|3|4|5|6|7:NORMAL:ENCRYPTION:ULINK:MCS1:
DATA {PN9}|PN15
[:SOURCE]:RADIO:GSM:SLOT0|[1]|2|3|4|5|6|7:NORMAL:ENCRYPTION:ULINK:MCS1:
DATA?
```

This command enables you to create and configure an uplink block type 5 encrypted data field for a normal timeslot.

*RST value: PN9

GSM - Synchronization Timeslot Encryption Data Field

```
[ :SOURCE]:RADIO:GSM:SLOT0|[1]|2|3|4|5|6|7:SYNC:ENCRYPTION PN9|PN15|
FIX4|"<file name>"|EXT|P4|P8|P16|P32|P64
```

```
[ :SOURCE]:RADIO:GSM:SLOT0|[1]|2|3|4|5|6|7:SYNC:ENCRYPTION?
```

This command enables you to create and configure an encrypted data field for a synchronization timeslot. The choices are timeslots 0 through 7 and PN9 (pseudorandom bit pattern), PN15 (pseudorandom bit pattern), FIX4 (4-bit repeating sequence data pattern), "<file name>" (a file in the catalog of binary files), Ext (external input data pattern), P4 (four 1's and four 0's), P8 (eight 1's and eight 0's), P16 (sixteen 1's and sixteen 0's), P32 (thirty-two 1's and thirty-two 0's), or P64 (sixty-four 1's and sixty-four 0's).

*RST value: PN9

NADC - Downlink Custom Timeslot

```
[SOURCE]:RADIO[:NADC]:SLOT[1]|2|3|4|5|6:DCUSTOM PN9|PN15|FIX4|
"<file name>"|EXT|P4|P8|P16|P32|P64
[SOURCE]:RADIO[:NADC]:SLOT[1]|2|3|4|5|6:DCUSTOM?
```

This command enables you to configure the data field for the selected downlink custom timeslot. The choices are timeslots 1 through 6 and the following:

PN9	Pseudorandom bit pattern
PN15	Pseudorandom bit pattern
FIX4	4-bit repeating sequence data pattern
"<file name>"	A file in the catalog of binary files
Ext	External input data pattern
P4	Four 1's and four 0's
P8	Eight 1's and eight 0's
P16	Sixteen 1's and sixteen 0's
P32	Thirty-two 1's and thirty-two 0's
P64	Sixty-four 1's and sixty-four 0's

*RST value: PN9

NADC - Downlink Traffic Channel Timeslot

```
[SOURCE]:RADIO[:NADC]:SLOT[1]|2|3|4|5|6:DTCHannel[:DATA] PN9|PN15|FIX4|  
"<file name>" |EXT|P4|P8|P32|P64
```

```
[SOURCE]:RADIO[:NADC]:SLOT[1]|2|3|4|5|6:DTCHannel[:DATA]?
```

This command sets a data pattern for the selected downlink traffic channel timeslot during framed transmission. The choices are timeslots 1 through 6 and PN9 (pseudorandom bit pattern), PN15 (pseudorandom bit pattern), FIX4 (4-bit repeating sequence data pattern), <file name> (a file in the catalog of binary files), or Ext (external input data pattern), P4 (four 1's and four 0's), P8 (eight 1's and eight 0's), P16 (sixteen 1's and sixteen 0's), P32 (thirty-two 1's and thirty-two 0's), or P64 (sixty-four 1's and sixty-four 0's).

*RST value: PN9

NADC - Uplink Custom Timeslot

```
[SOURCE]:RADIO[:NADC]:SLOT[1]|2|3|4|5|6:UCUSTom PN9|PN15|FIX4|  
"<file name>" |EXT|P4|P8|P16|P32|P64
```

```
[SOURCE]:RADIO[:NADC]:SLOT[1]|2|3|4|5|6:UCUSTom?
```

This command enables you to configure the data field for the selected uplink custom timeslot. The choices are timeslots 1 through 6 and the following:

PN9	Pseudorandom bit pattern
PN15	Pseudorandom bit pattern
FIX4	4-bit repeating sequence data pattern
"<file name>"	A file in the catalog of binary files
Ext	External input data pattern
P4	Four 1's and four 0's
P8	Eight 1's and eight 0's
P16	Sixteen 1's and sixteen 0's
P32	Thirty-two 1's and thirty-two 0's
P64	Sixty-four 1's and sixty-four 0's

*RST value: PN9

NADC - Uplink Traffic Channel Timeslot

```
[SOURce]:RADIO[:NADC]:SLOT[1|2|3|4|5|6:UTCHannel[:DATA] PN9|PN15|FIX4|
"<file name>" |EXT|P4|P8|P32|P64
```

```
[SOURce]:RADIO[:NADC]:SLOT[1|2|3|4|5|6:UTCHannel[:DATA]?
```

This command sets a data pattern for the selected uplink traffic channel timeslot during framed transmission. The choices are timeslots 1 through 6 and PN9 (pseudorandom bit pattern), PN15 (pseudorandom bit pattern), FIX4 (4-bit repeating sequence data pattern), <file name> (a file in the catalog of binary files), or Ext (external input data pattern), P4 (four 1's and four 0's), P8 (eight 1's and eight 0's), P16 (sixteen 1's and sixteen 0's), P32 (thirty-two 1's and thirty-two 0's), or P64 (sixty-four 1's and sixty-four 0's).

*RST value: PN9

PDC - Downlink Custom Timeslot

```
[:SOURce]:RADIO:PDC:SLOT0|[1|2|3|4|5:DCUSTom PN9|PN15|FIX4|"<file name>" |
EXT|P4|P8|P16|P32|P64
```

```
[:SOURce]:RADIO:PDC:SLOT0|[1|2|3|4|5:DCUSTom?
```

This command enables you to configure the data field for the selected downlink custom timeslot. The choices are timeslots 0 through 5 and the following:

PN9	Pseudorandom bit pattern
PN15	Pseudorandom bit pattern
FIX4	4-bit repeating sequence data pattern
"<file name>"	A file in the catalog of binary files
Ext	External input data pattern
P4	Four 1's and four 0's
P8	Eight 1's and eight 0's
P16	Sixteen 1's and sixteen 0's
P32	Thirty-two 1's and thirty-two 0's
P64	Sixty-four 1's and sixty-four 0's

*RST value: PN9

PDC - Downlink Traffic Channel Timeslot

```
[ :SOURCE ] : RADIo : PDC : SLoT0 | [ 1 ] | 2 | 3 | 4 | 5 : DTCHannel [ : TCHannel ] PN9 | PN15 |  
FIX4 | "<file name>" | EXT | P4 | P8 | P16 | P32 | P64
```

```
[ :SOURCE ] : RADIo : PDC : SLoT0 | [ 1 ] | 2 | 3 | 4 | 5 : DTCHannel [ : TCHannel ] ?
```

This command sets a data pattern for the selected downlink traffic channel field. The choices are timeslots 0 through 5 and PN9 (pseudorandom bit pattern), PN15 (pseudorandom bit pattern), FIX4 (4-bit repeating sequence data pattern), "<file name>" (a file in the catalog of binary files), Ext (external input data pattern), P4 (four 1's and four 0's), P8 (eight 1's and eight 0's), P16 (sixteen 1's and sixteen 0's), P32 (thirty-two 1's and thirty-two 0's), or P64 (sixty-four 1's and sixty-four 0's).

*RST value: PN9

PDC - Uplink Custom Timeslot

```
[ :SOURCE ] : RADIo : PDC : SLoT0 | [ 1 ] | 2 | 3 | 4 | 5 : UCUSTom PN9 | PN15 | FIX4 | "<file name>" |  
EXT | P4 | P8 | P16 | P32 | P64
```

```
[ :SOURCE ] : RADIo : PDC : SLoT0 | [ 1 ] | 2 | 3 | 4 | 5 : UCUSTom ?
```

This command enables you to configure the data field for the selected uplink custom timeslot. The choices are timeslots 0 through 5 and the following:

PN9	Pseudorandom bit pattern
PN15	Pseudorandom bit pattern
FIX4	4-bit repeating sequence data pattern
"<file name>"	A file in the catalog of binary files
Ext	External input data pattern
P4	Four 1's and four 0's
P8	Eight 1's and eight 0's
P16	Sixteen 1's and sixteen 0's
P32	Thirty-two 1's and thirty-two 0's
P64	Sixty-four 1's and sixty-four 0's

*RST value: PN9

PDC - Uplink Traffic Channel Timeslot

```
[ :SOURce]:RADio:PDC:SLOT0|[1]|2|3|4|5:UTCHannel[:TCHannel] PN9|PN15|
FIX4| "<file name>" |EXT|P4|P8|P16|P32|P64
[:SOURce]:RADio:PDC:SLOT0|[1]|2|3|4|5:UTCHannel[:TCHannel]?
```

This command sets a data pattern for the uplink traffic channel field. The choices are timeslots 0 through 5 and PN9 (pseudorandom bit pattern), PN15 (pseudorandom bit pattern), FIX4 (4-bit repeating sequence data pattern), "<file name>" (a file in the catalog of binary files), Ext (external input data pattern), P4 (four 1's and four 0's), P8 (eight 1's and eight 0's), P16 (sixteen 1's and sixteen 0's), P32 (thirty-two 1's and thirty-two 0's), or P64 (sixty-four 1's and sixty-four 0's).

*RST value: PN9

PHS - Downlink Custom Timeslot

```
[SOURce]:RADio:PHS:DLINK:SLOT[1]|2|3|4:CUSTOm PN9|PN15|FIX4| "<file name>" |
EXT|P4|P8|P16|P32|P64
[SOURce]:RADio:PHS:DLINK:SLOT[1]|2|3|4:CUSTOm?
```

This command enables you to configure the data field for the selected downlink custom timeslot. The choices are timeslots 1 through 4 and the following:

PN9	Pseudorandom bit pattern
PN15	Pseudorandom bit pattern
FIX4	4-bit repeating sequence data pattern
"<file name>"	A file in the catalog of binary files
Ext	External input data pattern
P4	Four 1's and four 0's
P8	Eight 1's and eight 0's
P16	Sixteen 1's and sixteen 0's
P32	Thirty-two 1's and thirty-two 0's
P64	Sixty-four 1's and sixty-four 0's

*RST value: PN9

PHS - Downlink Traffic Channel Timeslot

```
[SOURCE]:RADIO:PHS:DLINK:SLOT[1]|2|3|4:TCHANNEL[:TCHANNEL] PN9|PN15|FIX4|  
"<file name>"|EXT|P4|P8|P16|P32|P64  
[SOURCE]:RADIO:PHS:DLINK:SLOT[1]|2|3|4:TCHANNEL[:TCHANNEL]?
```

This command enables you to customize the selected downlink traffic channel timeslot. The choices are timeslots 1 through 4 and PN9 (pseudorandom bit pattern), PN15 (pseudorandom bit pattern), FIX4 (4-bit repeating sequence data pattern), "<file name>" (a file in the displayed catalog of binary files), or Ext (external input data pattern), P4 (four 1's and four 0's), P8 (eight 1's and eight 0's), P16 (sixteen 1's and sixteen 0's), P32 (thirty-two 1's and thirty-two 0's), or P64 (sixty-four 1's and sixty-four 0's).

*RST value: PN9

PHS - Uplink Custom Timeslot

```
[SOURCE]:RADIO:PHS:ULINK:SLOT[1]|2|3|4:CUSTOM PN9|PN15|FIX4|"<file name>"|  
EXT|P4|P8|P16|P32|P64  
[SOURCE]:RADIO:PHS:ULINK:SLOT[1]|2|3|4:CUSTOM?
```

This command enables you to configure the data field for the selected uplink custom timeslot. The choices are timeslots 1 through 4 and the following:

PN9	Pseudorandom bit pattern
PN15	Pseudorandom bit pattern
FIX4	4-bit repeating sequence data pattern
"<file name>"	A file in the catalog of binary files
Ext	External input data pattern
P4	Four 1's and four 0's
P8	Eight 1's and eight 0's
P16	Sixteen 1's and sixteen 0's
P32	Thirty-two 1's and thirty-two 0's
P64	Sixty-four 1's and sixty-four 0's

*RST value: PN9

PHS - Uplink Traffic Channel Timeslot

```
[SOURCE]:RADIO:PHS:ULINK:SLOT[1]|2|3|4:TCHannel[:TCHannel] PN9|PN15|FIX4|  
"<file name>"|EXT|P4|P8|P16|P32|P64  
[SOURCE]:RADIO:PHS:ULINK:SLOT[1]|2|3|4:TCHannel[:TCHannel]?
```

This command enables you to select the data pattern for the selected uplink traffic channel timeslot. The choices are timeslots 1 through 4 and PN9 (pseudorandom bit pattern), PN15 (pseudorandom bit pattern), FIX4 (4-bit repeating sequence data pattern), "<file name>" (a file in the displayed catalog of binary files), or Ext (external input data pattern), P4 (four 1's and four 0's), P8 (eight 1's and eight 0's), P16 (sixteen 1's and sixteen 0's), P32 (thirty-two 1's and thirty-two 0's), or P64 (sixty-four 1's and sixty-four 0's).

*RST value: PN9

TETRA - Downlink Continuous Custom Timeslot

```
[ :SOURCE]:RADIO:TETRA:SLOT[1]|2|3|4:DCCustom PN9|PN15|FIX4|  
"<file name>"|EXT|P4|P8|P16|P32|P64  
[ :SOURCE]:RADIO:TETRA:SLOT[1]|2|3|4:DCCustom?
```

This command configures the downlink continuous custom timeslot data field. The choices are timeslots 1 through 4 and PN9 (pseudorandom bit pattern), PN15 (pseudorandom bit pattern), FIX4 (4-bit repeating sequence data pattern), "<file name>" (a file in the catalog of binary files), or Ext (external input data pattern), P4 (four 1's and four 0's), P8 (eight 1's and eight 0's), P16 (sixteen 1's and sixteen 0's), P32 (thirty-two 1's and thirty-two 0's), or P64 (sixty-four 1's and sixty-four 0's).

*RST value: PN9

TETRA - Downlink Continuous Normal Timeslot

```
[ :SOURCE]:RADIO:TETRA:SLOT[1]|2|3|4:DCNormal[:DATA] PN9|PN15|  
FIX4|"<file name>"|EXT|P4|P8|P16|P32|P64  
[ :SOURCE]:RADIO:TETRA:SLOT[1]|2|3|4:DCNormal[:DATA]?
```

This command enables you to configure the selected downlink continuous normal timeslot data field. The choices are timeslots 1 through 4 and PN9 (pseudorandom bit pattern), PN15 (pseudorandom bit pattern), FIX4 (4-bit repeating sequence data pattern), "<file name>" (a file in the catalog of binary files), or Ext (external input data pattern), P4 (four 1's and four 0's), P8 (eight 1's and eight 0's), P16 (sixteen 1's and sixteen 0's), P32 (thirty-two 1's and thirty-two 0's), or P64 (sixty-four 1's and sixty-four 0's).

*RST value: PN9

TETRA - Downlink Continuous Synchronization Timeslot

```
[ :SOURCE ] :RADio:TETRa:SLOT[1] | 2 | 3 | 4 :DCSync[ :DATA ] PN9 | PN15 | FIX4 |  
"<file name>" | EXT | P4 | P8 | P16 | P32 | P64
```

```
[ :SOURCE ] :RADio:TETRa:SLOT[1] | 2 | 3 | 4 :DCSync[ :DATA ] ?
```

This command enables you to configure the selected downlink continuous synchronization timeslot data field. The choices are timeslots 1 through 4 and PN9 (pseudorandom bit pattern), PN15 (pseudorandom bit pattern), FIX4 (4-bit repeating sequence data pattern), "<file name>" (a file in the catalog of binary files), or Ext (external input data pattern), P4 (four 1's and four 0's), P8 (eight 1's and eight 0's), P16 (sixteen 1's and sixteen 0's), P32 (thirty-two 1's and thirty-two 0's), or P64 (sixty-four 1's and sixty-four 0's).

*RST value: PN9

TETRA - Downlink Discontinuous Custom Timeslot

```
[ :SOURCE ] :RADio:TETRa:SLOT[1] | 2 | 3 | 4 :DDCustom PN9 | PN15 | FIX4 |  
"<file name>" | EXT | P4 | P8 | P16 | P32 | P64
```

```
[ :SOURCE ] :RADio:TETRa:SLOT[1] | 2 | 3 | 4 :DDCustom ?
```

This command configures the downlink discontinuous custom timeslot data field. The choices are timeslots 1 through 4 and PN9 (pseudorandom bit pattern), PN15 (pseudorandom bit pattern), FIX4 (4-bit repeating sequence data pattern), "<file name>" (a file in the catalog of binary files), or Ext (external input data pattern), P4 (four 1's and four 0's), P8 (eight 1's and eight 0's), P16 (sixteen 1's and sixteen 0's), P32 (thirty-two 1's and thirty-two 0's), or P64 (sixty-four 1's and sixty-four 0's).

*RST value: PN9

TETRA - Downlink Discontinuous Normal Timeslot

```
[ :SOURCE ] :RADio:TETRa:SLOT[1] | 2 | 3 | 4 :DDNormal[ :DATA ] PN9 | PN15 |  
FIX4 | "<file name>" | EXT | P4 | P8 | P16 | P32 | P64
```

```
[ :SOURCE ] :RADio:TETRa:SLOT[1] | 2 | 3 | 4 :DDNormal[ :DATA ] ?
```

This command enables you to configure the selected downlink discontinuous normal timeslot data field. The choices are timeslots 1 through 4 and PN9 (pseudorandom bit pattern), PN15 (pseudorandom bit pattern), FIX4 (4-bit repeating sequence data pattern), "<file name>" (a file in the catalog of binary files), or Ext (external input data pattern), P4 (four 1's and four 0's), P8 (eight 1's and eight 0's), P16 (sixteen 1's and sixteen 0's), P32 (thirty-two 1's and thirty-two 0's), or P64 (sixty-four 1's and sixty-four 0's).

*RST value: PN9

TETRA - Downlink Discontinuous Synchronization Timeslot

```
[ :SOURce]:RADio:TETRa:SLOT[1] | 2 | 3 | 4:DDSync[ :DATA] PN9 | PN15 | FIX4 |  
"<file name>" | EXT | P4 | P8 | P16 | P32 | P64
```

```
[ :SOURce]:RADio:TETRa:SLOT[1] | 2 | 3 | 4:DDSync[ :DATA]?
```

This command enables you to configure the selected downlink discontinuous synchronization timeslot data field. The choices are timeslots 1 through 4 and PN9 (pseudorandom bit pattern), PN15 (pseudorandom bit pattern), FIX4 (4-bit repeating sequence data pattern), "<file name>" (a file in the catalog of binary files), or Ext (external input data pattern), P4 (four 1's and four 0's), P8 (eight 1's and eight 0's), P16 (sixteen 1's and sixteen 0's), P32 (thirty-two 1's and thirty-two 0's), or P64 (sixty-four 1's and sixty-four 0's).

*RST value: PN9

TETRA - Uplink Control 1 Timeslot

```
[ :SOURce]:RADio:TETRa:SLOT[1] | 2 | 3 | 4:UC1[ :DATA] PN9 | PN15 | FIX4 |  
"<file name>" | EXT | P4 | P8 | P16 | P32 | P64
```

```
[ :SOURce]:RADio:TETRa:SLOT[1] | 2 | 3 | 4:UC1[ :DATA]?
```

This command enables you to configure the selected uplink control 1 data field. The choices are timeslots 1 through 4 and PN9 (pseudorandom bit pattern), PN15 (pseudorandom bit pattern), FIX4 (4-bit repeating sequence data pattern), "<file name>" (a file in the catalog of binary files), or Ext (external input data pattern), P4 (four 1's and four 0's), P8 (eight 1's and eight 0's), P16 (sixteen 1's and sixteen 0's), P32 (thirty-two 1's and thirty-two 0's), or P64 (sixty-four 1's and sixty-four 0's).

*RST value: PN9

TETRA - Uplink Control 2 Timeslot

```
[ :SOURce]:RADio:TETRa:SLOT[1] | 2 | 3 | 4:UC2[ :DATA] PN9 | PN15 | FIX4 |  
"<file name>" | EXT | P4 | P8 | P16 | P32 | P64
```

```
[ :SOURce]:RADio:TETRa:SLOT[1] | 2 | 3 | 4:UC2[ :DATA]?
```

This command enables you to configure the selected uplink control 2 data field. The choices are timeslots 1 through 4 and PN9 (pseudorandom bit pattern), PN15 (pseudorandom bit pattern), FIX4 (4-bit repeating sequence data pattern), "<file name>" (a file in the catalog of binary files), or Ext (external input data pattern), P4 (four 1's and four 0's), P8 (eight 1's and eight 0's), P16 (sixteen 1's and sixteen 0's), P32 (thirty-two 1's and thirty-two 0's), or P64 (sixty-four 1's and sixty-four 0's).

*RST value: PN9

TETRA - Uplink Custom Timeslot

```
[ :SOURCE]:RADio:TETRa:SLOT[1] | 2 | 3 | 4:UCUSTom PN9 | PN15 | FIX4 |  
"<file name>" | EXT | P4 | P8 | P16 | P32 | P64
```

```
[ :SOURCE]:RADio:TETRa:SLOT[1] | 2 | 3 | 4:UCUSTom?
```

This command enables you to configure the uplink custom data field. The choices are timeslots 1 through 4 and PN9 (pseudorandom bit pattern), PN15 (pseudorandom bit pattern), FIX4 (4-bit repeating sequence data pattern), "<file name>" (a file in the catalog of binary files), or Ext (external input data pattern), P4 (four 1's and four 0's), P8 (eight 1's and eight 0's), P16 (sixteen 1's and sixteen 0's), P32 (thirty-two 1's and thirty-two 0's), or P64 (sixty-four 1's and sixty-four 0's).

*RST value: PN9

TETRA - Uplink Normal Timeslot

```
[ :SOURCE]:RADio:TETRa:SLOT[1] | 2 | 3 | 4:UNORmal[:DATA] PN9 | PN15 | FIX4 |  
"<file name>" | EXT | P4 | P8 | P16 | P32 | P64
```

```
[ :SOURCE]:RADio:TETRa:SLOT[1] | 2 | 3 | 4:UNORmal[:DATA]?
```

This command enables you to configure the selected uplink normal data field. The choices are timeslots 1 through 4 and PN9 (pseudorandom bit pattern), PN15 (pseudorandom bit pattern), FIX4 (4-bit repeating sequence data pattern), "<file name>" (a file in the catalog of binary files), or Ext (external input data pattern), P4 (four 1's and four 0's), P8 (eight 1's and eight 0's), P16 (sixteen 1's and sixteen 0's), P32 (thirty-two 1's and thirty-two 0's), or P64 (sixty-four 1's and sixty-four 0's).

*RST value: PN9

Data Selection for Unframed Transmissions

Custom

```
[ :SOURce]:RADio:CUSTom:DATA PN9 | PN11 | PN15 | PN20 | PN23 | FIX4 | "<file name>" |  
EXT | P4 | P8 | P16 | P32 | P64  
[ :SOURce]:RADio:CUSTom:DATA?
```

DECT

```
[ :SOURce]:RADio:DECT:DATA PN9 | PN11 | PN15 | PN20 | PN23 | FIX4 |  
"<file name>" | EXT | P4 | P8 | P16 | P32 | P64  
[ :SOURce]:RADio:DECT:DATA?
```

EDGE

```
[ :SOURce]:RADio:EDGE:DATA PN9 | PN15 | FIX4 | "<file name>" | EXT | P4 | P8 | P16 | P32 |  
P64  
[ :SOURce]:RADio:EDGE:DATA?
```

GSM

```
[ :SOURce]:RADio:GSM:DATA PN9 | PN11 | PN15 | PN20 | PN23 | FIX4 |  
"<file name>" | EXT | P4 | P8 | P16 | P32 | P64  
[ :SOURce]:RADio:GSM:DATA?
```

NADC

```
[ :SOURce]:RADio[:NADC]:DATA PN9 | PN11 | PN15 | PN20 | PN23 | FIX4 |  
"<file name>" | EXT | P4 | P8 | P16 | P32 | P64  
[ :SOURce]:RADio:NADC:DATA?
```

PDC

```
[ :SOURce]:RADio:PDC:DATA PN9 | PN11 | PN15 | PN20 | PN23 | FIX4 |  
"<file name>" | EXT | P4 | P8 | P16 | P32 | P64  
[ :SOURce]:RADio:PDC:DATA?
```

PHS

```
[ :SOURce]:RADio:PHS:DATA PN9 | PN11 | PN15 | PN20 | PN23 | FIX4 |  
"<file name>" | EXT | P4 | P8 | P16 | P32 | P64  
[ :SOURce]:RADio:PHS:DATA?
```

TETRA

```
[ :SOURCE ]:RADio:TETRA:DATA PN9 | PN11 | PN15 | PN20 | PN23 | FIX4 |  
"<file name>" | EXT | P4 | P8 | P16 | P32 | P64
```

```
[ :SOURCE ]:RADio:TETRA:DATA?
```

This command sets a data pattern for unframed transmission:

PN9 through PN23	Pseudorandom bit pattern
FIX4	4-bit repeating sequence data pattern
"<file name>"	A file in the catalog of binary files
Ext	External input data pattern
P4	Four 1's and four 0's
P8	Eight 1's and eight 0's
P16	Sixteen 1's and sixteen 0's
P32	Thirty-two 1's and thirty-two 0's
P64	Sixty-four 1's and sixty-four 0's

NOTE Pattern Repeat and Pattern Trigger functions are *not* available if you use either a PN data sequence, or an external data source.

*RST value:

- Custom, DECT, GSM, NADC, PDC, PHS, TETRA: PN23
- EDGE: PN9

Data Out

```
[ :SOURCE ]:RADio:EDGE:BNCMux:DOUT MDATa | EDATa  
[ :SOURCE ]:RADio:EDGE:BNCMux:DOUT?
```

This command sets the output of the DATA OUT rear panel BNC/SMB connector.

*RST value: MDATa

Default State

```
[ :SOURCE ]:RADio:<desired format>:DEFault
```

This command returns all of the digital modulation format parameters to their default conditions. It does not affect any other instrument state parameters.

Differential Data Encoding

Custom

```
[ :SOURce]:RADio:CUSTom:DENCode ON|OFF|1|0
[:SOURce]:RADio:CUSTom:DENCode?
```

GSM

```
[ :SOURce]:RADio:GSM:DENCode ON|OFF|1|0
[:SOURce]:RADio:GSM:DENCode?
```

This command sets the operating state of the differential data encoding. For a detailed explanation of differential data encoding, see [“Understanding Differential Data Encoding”](#) on page 6-10.

Values: On (1) and Off (0)

*RST value: On

Differential Encoding

User FSK Files

```
:MEMory:DATA:FSK "<file name>",num states,f0,f1,...
[,diff state,num diff states,diff0,diff1,...]
:MEMory:DATA:FSK "<file name>"?
```

User I/Q Files

```
:MEMory:DATA:IQ "<file name>",offsetQ,num states,i0,q0,i1,q1,...
[,diff state,num diff states,diff0,diff1,...]
:MEMory:DATA:IQ "<file name>"?
```

The user-defined FSK modulation and user-defined I/Q modulation SCPI commands contain the differential encoding information. Before designing a differential encoding scheme, you must first define the FSK or I/Q modulation to be encoded. The actual differential encoding-related input appears bolded in the command listing above.

This command line enables you to define the differential encoding criteria.

```
diff state   Toggle for differential encoding. (ON|OFF|1|0)
num diff
states       The number of differential states (0 through 256)
diff0        Value of first differential state (an integer value from -128 through +127)
diff1        Value of second differential state (an integer value from -128 through
+127)
```

EDGE BNC MUX Settings

```
[ :SOURCE ]:RADio:EDGE:BNCMux:DCOut BCLock|GCLock  
[ :SOURCE ]:RADio:EDGE:BNCMux:DCOut?
```

This command selects the output signal for the rear panel DATA CLK OUT connector.

BCLock Bit clock-a signal that is normally 812.5 kHz.
GCLock Gated clock-a signal that has the same clock rate as the bit clock, but is only active with E-field data.

```
[ :SOURCE ]:RADio:EDGE:BNCMux:DOut MDATA|EDATA  
[ :SOURCE ]:RADio:EDGE:BNCMux:DOut?
```

This command selects the output signal for the rear panel DATA OUT connector.

MDATA Multiframe data-a signal that contains all of the multiframe data.
EDATA E-field data-a signal that only has coded data.

```
[ :SOURCE ]:RADio:EDGE:BNCMux:EVENT MTRigger|FTRigger  
[ :SOURCE ]:RADio:EDGE:BNCMux:EVENT?
```

This command selects the output signal for the rear panel EVENT 1 connector.

MTRigger Multiframe trigger-sends one clock pulse at every first cycle of a multiframe to indicate the beginning of a sequence.
FTRigger Frame trigger-sends one clock pulse at every first cycle of a frame to indicate the beginning.

```
[ :SOURCE ]:RADio:EDGE:BNCMux:SSOut IGAT|TBSync  
[ :SOURCE ]:RADio:EDGE:BNCMux:SSOut?
```

This command selects the output signal for the rear panel SYMBOL SYNC OUT connector.

IGAT Interleave gating-a signal with an interleave pattern for every 4 frames.
TBSync 3-Bit sync-a signal that is three times the bit clock rate.

Extended Tail (ET) Field

```
[ :SOURCE ]:RADio:GSM:SLOT0|[1]|2|3|4|5|6|7:ACCEss:ETail <bit_pattern>  
[ :SOURCE ]:RADio:GSM:SLOT0|[1]|2|3|4|5|6|7:ACCEss:ETail?
```

This command specifies the extended tail bits (8 bits) field for the selected access timeslot.

Range: 00 to FF

*RST value: 3A

External 13 MHz Reference State

```
[ :SOURce]:RADio:EDGE:EREFerence ON|OFF|1|0  
[ :SOURce]:RADio:EDGE:EREFerence?
```

```
[ :SOURce]:RADio:GSM:EREFerence ON|OFF|1|0  
[ :SOURce]:RADio:GSM:EREFerence?
```

This command sets an external 13 MHz reference for the internal reference clock for the data generator. The choices are ON (1) or OFF (0). Supply the 13 MHz signal to the rear panel 13 MHz IN connector. This signal is for the data clock only. The RF signal still requires the internal or external 10 MHz reference.

*RST value: Off

External Data Clock Configuration

Custom

```
[ :SOURce]:RADio:CUSTom:EDCLock SYMBOL|NORMAl  
[ :SOURce]:RADio:CUSTom:EDCLock?
```

Other Formats

```
[ :SOURce]:RADio:<desired format>:EDCLock SYMBOL|NORMAl  
[ :SOURce]:RADio:<desired format>:EDCLock?
```

This command sets the external data clock use. The options are as follows:

- | | |
|--------|---|
| Normal | You must supply a signal to the DATA CLOCK INPUT connector to clock the DATA and SYMBOL SYNC signals. |
| Symbol | No signal is required at the DATA CLOCK INPUT connector. Instead, the data is clocked on both the rising and falling edges of the SYMBOL SYNC signal. |

This is a persistent state that is set to Normal at the factory.

External Data Delay Query

Custom

```
[ :SOURce]:RADio:CUSTom:EDATa:DELay?
```

Other Formats

```
[ :SOURce]:RADio:<desired format>:EDATa:DELay?
```

These commands query the amount of delay (in symbols) from the External Data input to the beginning of the symbol on the I/Q outputs and the RF output for a particular format. This value is reported (and unchanged) even if the format is off.

External Frame Trigger Configuration - Delay Bits, Delay State, Type

External Frame Trigger Delay Bits

```
[ :SOURCE ] : RADio : <desired format> : TRIGger [ :SOURCE ] : EXTernal : DELay <value>  
[ :SOURCE ] : RADio : <desired format> : TRIGger [ :SOURCE ] : EXTernal : DELay ?
```

This command selects the number of delay bits for the external trigger delay.

Range:

- DECT, PDC: 0 to 10000
- EDGE, GSM, NADC, TETRA: 0 to 65535
- PHS: 0 to 65000

*RST value: 0

External Frame Trigger Delay State

Custom

```
[ :SOURCE ] : RADio : CUSTom : TRIGger [ :SOURCE ] : EXTernal : DELay : STATE ON | OFF | 1 | 0  
[ :SOURCE ] : RADio : CUSTom : TRIGger [ :SOURCE ] : EXTernal : DELay : STATE ?
```

Other Formats

```
[ :SOURCE ] : RADio : <desired format> : TRIGger [ :SOURCE ] : EXTernal : DELay :  
STATE ON | OFF | 1 | 0  
[ :SOURCE ] : RADio : <desired format> : TRIGger [ :SOURCE ] : EXTernal : DELay : STATE ?
```

This command determines the operating state of the external trigger delay. The choices are On (1) or Off (0).

*RST value: Off

External Frame Trigger Type

```
[ :SOURCE ] : RADio : <desired format> : TRIGger [ :SOURCE ] : EXTernal [ :TYPE ] SINGLE |  
GATE | RESet | MANual  
[ :SOURCE ] : RADio : <desired format> : TRIGger [ :SOURCE ] : EXTernal [ :TYPE ] ?
```

This command sets the external frame trigger type. The options are as follows:

- | | |
|--------|---|
| SINGLE | In Single Shot External Frame Trigger mode, the pattern waits at the last bit until triggered. If the pattern is playing and a trigger signal is received before the last bit of the pattern has been played, the trigger signal is ignored. If triggered after end of pattern, the pattern resets and runs. |
| GATE | In Gated External Frame Trigger mode, the pattern waits at last bit until the signal generator receives an inactive-to-active trigger transition, at which time the pattern resets and runs to the end. At end of pattern, if trigger level is still active, then the pattern repeats again. Otherwise, pattern will stop and wait at the last bit until the trigger signal transitions to active. After waiting at the last bit, upon receiving an inactive-to-active trigger transition, the pattern resets and runs. |

- RESet In Reset & Run External Frame Trigger mode, the trigger input latch is reset by a register bit in the status byte. When the register bit is released, the next trigger signal will reset and start the pattern. Prior to the trigger signal, the pattern waits at last bit until triggered. Pattern will continue to run repeatedly, independent of trigger until trigger input latch bit is toggled in the status byte. Once the trigger input latch register bit is toggled, the pattern will play to the end and wait at the last bit for the next trigger signal.
- MANual In Manual Reset & Run External Frame Trigger mode, pattern is reset immediately (without running to the end) and restarts and runs repeatedly until next trigger transition to active.

*RST value: Single Shot

Frame Repeat

Custom

```
[ :SOURCE]:RADio:CUSTom:REPeat SINGLE|CONTinuous  
[ :SOURCE]:RADio:CUSTom:REPeat?
```

Other Formats

```
[ :SOURCE]:RADio:<desired format>:REPeat SINGLE|CONTinuous  
[ :SOURCE]:RADio:<desired format>:REPeat?
```

This command sets the output of the selected frame:

SINGLE Outputs one occurrence of the selected frame.

CONTinuous Outputs a continuous stream of the selected frame.

*RST value: Continuous

Frame Transmission Rate

```
[ :SOURCE]:RADio[:NADC]:FRATe FULL|HALF  
[ :SOURCE]:RADio[:NADC]:FRATe?
```

```
[ :SOURCE]:RADio:PDC:FRATe FULL|HALF  
[ :SOURCE]:RADio:PDC:FRATe?
```

This command sets the transmission rate for your framed data pattern.

For NADC format, the choices are Full (timeslots 1, 2, and 3 are paired with timeslots 4, 5, and 6, respectively), or Half (6 individual timeslots).

For PDC format, the choices are Full (timeslots 0, 1, and 2 are paired with timeslots 3, 4, and 5, respectively), or Half (6 individual timeslots and faster transmissions).

Notice that your selection, either full-rate or half-rate, is shown on the display directly above the timeslot pattern visual representation.

*RST value: Full

Frequency Channel Configuration - Band, Number, and State

Frequency Channel Band

```
[ :SOURce ]:RADio:DECT|PHS|TETRA:FCHannel:BAND STANdard
[ :SOURce ]:RADio:EDGE:FCHannel:BAND BPGSm|MPGSm|BEGSm|MEGSm|BRGSm|
MRGSm|BDCS|MDCS|BPCS|MPCS|B450|B480|B850|M450|M480|M850
[ :SOURce ]:RADio:GSM:FCHannel:BAND BPGSm|MPGSm|BEGSm|MEGSm|BRGSm|
MRGSm|BDCS|MDCS|BPCS|MPCS|B450|B480|B850|M450|M480|M850
[SOURce]:RADio[:NADC]:FCHannel:BAND BASE|MOBile
[ :SOURce ]:RADio:PDC:FCHannel:BAND B8|M8|B15|M15
[ :SOURce ]:RADio:<desired format>:FCHannel:BAND?
```

This command selects the frequency channel band. The output frequency depends on both the channel band and channel number selections.

EDGE & GSM Selections		PDC Selections
BPGSm = P-GSM Base	MRGSm = R-GSM Mobile	B8 = 800 MHz Base
MPGSm = P-GSM Mobile	BDCS = DCS Base	M8 = 800 MHz Mobile
BEGm = E-GSM Base	MDCS = DCS Mobile	B15 = 1500 MHz Base
MEGSm = E-GSM Mobile	BPCS = PCS Base	M15 = 1500 MHz Mobile
BRGSm = R-GSM Base	MPCS = PCS Mobile	
B450 = GSM 450 band Base Channels 259–293	M450 = GSM 450 band Mobile Channels 259–293	
B480 = GSM 480 band Base Channels 306–340	M480 = GSM 480 band Mobile Channels 306–340	
B850 = GSM 850 band Base Channels 128–251	M850 = GSM 850 band Mobile Channels 128–251	

*RST value:

- DECT, PHS, and TETRA: Standard
- EDGE: BPGSm
- GSM: BEGm
- NADC: Base
- PDC: B8

Frequency Channel Number Selection

```
[ :SOURce]:RADio:<desired format>:FCHannel:NUMBER <number>  
[ :SOURce]:RADio:<desired format>:FCHannel:NUMBER?
```

This command selects the frequency channel number. The output frequency depends on both the channel band and channel number selections.

Range:

- DECT: 0 through 9
- EDGE: 1 through 124
- GSM: 1 through 124
- NADC: 1 through 1023
- PDC: 0 through 640
- PHS: 1 through 225
- TETRA: 1 through 100

*RST value: 1

Frequency Channel Mode State

```
[ :SOURce]:RADio:<desired format>:FCHannel[:STATE] ON|OFF|1|0  
[ :SOURce]:RADio:<desired format>:FCHannel[:STATE]?
```

This command selects the frequency channel mode state. The output frequency depends on both the channel band and channel number selections.

*RST value: Off

Filter Configuration - Alpha, BbT, Optimization, Type

Filter Alpha (for Nyquist or Root Nyquist)

Custom

```
[ :SOURce ]:RADio:CUSTom:ALPHa <value>  
[ :SOURce ]:RADio:CUSTom:ALPHa?
```

Other Formats

```
[ :SOURce ]:RADio:<desired format>:ALPHa <value>  
[ :SOURce ]:RADio:<desired format>:ALPHa?
```

This command changes the Nyquist or root Nyquist filter's alpha value. This command is effective only *after* choosing a root Nyquist or Nyquist filter; it does not effect other types of filters.

Range: 0.000 through 1.000

*RST value:

- Custom, NADC, TETRA: 0.350
- Other formats: 0.500

Filter BbT (for Gaussian)

Custom

```
[ :SOURce ]:RADio:CUSTom:BBT <value>  
[ :SOURce ]:RADio:CUSTom:BBT?
```

Other Formats

```
[ :SOURce ]:RADio:<desired format>:BBT <value>  
[ :SOURce ]:RADio:<desired format>:BBT?
```

This command changes the bandwidth-multiplied-by-bit-time (BbT) filter parameter.

This command is effective only *after* choosing a Gaussian filter. It does not have an effect on other types of filters.

Range: 0.100 through 1.000

*RST value: 0.350

Filter Optimization

Custom

```
[ :SOURce]:RADio:CUSTom:CHANnel EVM|ACP
[ :SOURce]:RADio:CUSTom:CHANnel?
```

Other Formats

```
[ :SOURce]:RADio:<desired format>:CHANnel EVM|ACP
[ :SOURce]:RADio:<desired format>:CHANnel?
```

This command is used to optimize the filter for minimized error vector magnitude (select EVM) or for minimized adjacent channel power (select ACP). The EVM selection provides the most ideal passband. The ACP selection improves stopband rejection. This feature only applies to root Nyquist and Nyquist filters. The softkey is grayed out when any other filter is selected.

*RST value:

- DECT, PDC, PHS, TETRA: EVM
- Custom, EDGE: GSM, NADC: ACP

Filter Type

Custom

```
[ :SOURce]:RADio:CUSTom:FILTer
RNYQuist|NYQuist|GAUSSian|RECTangle|IS95|IS95_EQ|IS95_MOD|IS95_MOD_EQ|
AC4Fm|UGGaussian|"<file name>"
[ :SOURce]:RADio:CUSTom:FILTer?
```

EDGE

```
[ :SOURce]:RADio:EDGE:FILTer RNYQuist|NYQuist|GAUSSian|RECTangle|
IS95|IS95_EQ|IS95_MOD|IS95_MOD_EQ|EDGE|AC4Fm|UGGaussian|"<file name>"
[ :SOURce]:RADio:EDGE:FILTer?
```

GSM

```
[ :SOURce]:RADio:GSM:FILTer RNYQuist|NYQuist|GAUSSian|RECTangle|
IS95|IS95_EQ|IS95_MOD|IS95_MOD_EQ|AC4Fm|UGGaussian|"<file name>"
[ :SOURce]:RADio:GSM:FILTer?
```

Other Formats

```
[ :SOURce]:RADio:DECT|[NADC]|PDC|PHS|TETRa:FILTer RNYQuist|NYQuist|
GAUSSian|RECTangle|IS95|IS95_EQ|IS95_MOD|IS95_MOD_EQ|AC4Fm|UGGaussian|
"<file name>"
[ :SOURce]:RADio:DECT|[NADC]|PDC|PHS|TETRa:FILTer?
```

This command selects the pre-modulation filter type:

RNYQuist	Root Nyquist
NYQuist	Nyquist
GAUSSian	Gaussian
RECTangle	Rectangle
IS95	IS-95
IS95_EQ	IS-95 with equalizer
IS95_MOD	IS-95 modified
IS95_MOD_EQ	IS-95 modified with equalizer
AC4Fm	APCO 25 C4FM
EDGE	Linearized Gaussian
UGGaussian	UN 3/4 delay compatible, 0.300 fixed BbT, GSM Gaussian
"<file name>"	Any filter file that you have either created externally and downloaded into memory, or that you have created internally in the Define User FIR menu and then subsequently stored.

*RST value:

- Custom, NADC, PDC, PHS, TETRA: root Nyquist
- DECT, GSM: Gaussian
- EDGE: EDGE

FIX4 Data

Custom

```
[ :SOURce ]:RADio:CUSTom:DATA:FIX4 <0-15>  
[ :SOURce ]:RADio:CUSTom:DATA:FIX4?
```

This command enables you to select a binary, 4-bit repeating sequence data pattern for unframed transmission according to the modulation type, symbol rate, filter, and burst shape selected for the custom modulation format. `FIX4` must already be defined as the data type.

Range: 0000 to 1111

*RST value: 0000

DECT - Unframed Data Transmission

```
[ :SOURce ]:RADio:DECT:DATA:FIX4 <0-15>  
[ :SOURce ]:RADio:DECT:DATA:FIX4?
```

This command enables you to select a binary, 4-bit repeating sequence data pattern for unframed transmission according to the modulation type, symbol rate, filter, and burst shape selected for the DECT format. `FIX4` must already be defined as the data type.

Range: 0000 to 1111

*RST value: 0000

DECT - Portable Part Custom Timeslot

```
[SOURce]:RADio:DECT:PPart:SLOT0|[1]|2|3|4|5|6|7|8|9|10|  
11:CUSTom:FIX4 <0-15>
```

```
[SOURce]:RADio:DECT:PPart:SLOT0|[1]|2|3|4|5|6|7|8|9|10|11:CUSTom:FIX4?
```

This command enables you to select a binary, 4-bit repeating sequence data pattern to be used in the portable part custom data field of the selected timeslot. FIX4 must already be defined as the data type.

Range: 0000 to 1111

*RST value: 0000

DECT - Portable Part Low Capacity Timeslot B Field

```
[ :SOURce]:RADio:DECT:PPart:SLOT0|[1]|2|3|4|5|6|7|8|9|10|  
11:LCAPacity[:B]: FIX4 <0-15>
```

```
[ :SOURce]:RADio:DECT:PPart:SLOT0|[1]|2|3|4|5|6|7|8|9|10|11:LCAPacity[:B]:  
FIX4?
```

This command enables you to select a binary, 4-bit repeating sequence data pattern to be used in the portable part low capacity B field of the selected timeslot. FIX4 must already be defined as the data type.

Range: 0000 to 1111

*RST value: 0000

DECT - Portable Part Traffic Bearer Timeslot B Field

```
[ :SOURce]:RADio:DECT:PPart:SLOT0|[1]|2|3|4|5|6|7|8|9|10|11:TRAFfic[:B]:  
FIX4 <0-15>
```

```
[ :SOURce]:RADio:DECT:PPart:SLOT0|[1]|2|3|4|5|6|7|8|9|10|11:TRAFfic[:B]:  
FIX4?
```

This command enables you to select a binary, 4-bit repeating sequence data pattern to be used in the portable part traffic bearer B field of the selected timeslot. FIX4 must already be defined as the data type.

Range: 0000 to 1111

*RST value: 0000

DECT - Portable Part Low Capacity with Z Field Timeslot B Field

```
[ :SOURce]:RADio:DECT:PPart:SLOT0|[1]|2|3|4|5|6|7|8|9|10|11:ZLCapacity[:B]:  
FIX4 <0-15>
```

```
[ :SOURce]:RADio:DECT:PPart:SLOT0|[1]|2|3|4|5|6|7|8|9|10|11:ZLCapacity[:B]:  
FIX4?
```

This command enables you to select a binary, 4-bit repeating sequence data pattern to be used in the portable part low capacity with Z field B field of the selected timeslot. `FIX4` must already be defined as the data type.

Range: 0000 to 1111

*RST value: 0000

DECT - Portable Part Traffic Bearer with Z Field Timeslot B Field

```
[ :SOURce]:RADio:DECT:PPart:SLOT0|[1]|2|3|4|5|6|7|8|9|10|11:ZTRaffic[:B]:  
FIX4 <0-15>
```

```
[ :SOURce]:RADio:DECT:PPart:SLOT0|[1]|2|3|4|5|6|7|8|9|10|11:ZTRaffic[:B]:  
FIX4?
```

This command enables you to select a binary, 4-bit repeating sequence data pattern to be used in the portable part traffic bearer with Z field B field of the selected timeslot. `FIX4` must already be defined as the data type.

Range: 0000 to 1111

*RST value: 0000

DECT - Radio Fixed Part Custom Timeslot

```
[SOURce]:RADio:DECT:RFPart:SLOT0|[1]|2|3|4|5|6|7|8|9|10|  
11:CUSTom:FIX4 <0-15>
```

```
[SOURce]:RADio:DECT:RFPart:SLOT0|[1]|2|3|4|5|6|7|8|9|10|11:CUSTom:FIX4?
```

This command enables you to select a binary, 4-bit repeating sequence data pattern to be used in the selected radio fixed part custom timeslot. `FIX4` must already be defined as the data type.

Range: 0000 to 1111

*RST value: 0000

DECT - Radio Fixed Low Capacity Timeslot B Field

```
[ :SOURce]:RADio:DECT:RFPart:SLOT0|[1]|2|3|4|5|6|7|8|9|10|11:LCAPacity[:B]:  
FIX4 <0-15>
```

```
[ :SOURce]:RADio:DECT:RFPart:SLOT0|[1]|2|3|4|5|6|7|8|9|10|11:LCAPacity[:B]:  
FIX4?
```

This command enables you to select a binary, 4-bit repeating sequence data pattern to be used in the selected radio fixed part low capacity timeslot B field. `FIX4` must already be defined as the data type.

Range: 0000 to 1111

*RST value: 0000

DECT - Radio Fixed Traffic Bearer Timeslot B Field

```
[ :SOURce]:RADio:DECT:RFPart:SLOT0|[1]|2|3|4|5|6|7|8|9|10|11:TRAFfic[:B]:  
FIX4 <0-15>
```

```
[ :SOURce]:RADio:DECT:RFPart:SLOT0|[1]|2|3|4|5|6|7|8|9|10|11:TRAFfic[:B]:  
FIX4?
```

This command enables you to select a binary, 4-bit repeating sequence data pattern to be used in the selected radio fixed part traffic bearer timeslot B field. `FIX4` must already be defined as the data type.

Range: 0000 to 1111

*RST value: 0000

DECT - Radio Fixed Low Capacity with Z Field Timeslot B Field

```
[ :SOURce]:RADio:DECT:RFPart:SLOT0|[1]|2|3|4|5|6|7|8|9|10|11:ZLCapacity[:B]:  
:FIX4 <0-15>
```

```
[ :SOURce]:RADio:DECT:RFPart:SLOT0|[1]|2|3|4|5|6|7|8|9|10|11:ZLCapacity[:B]:  
:FIX4?
```

This command enables you to select a binary, 4-bit repeating sequence data pattern to be used in the selected radio fixed part low capacity with Z field timeslot B field. `FIX4` must already be defined as the data type.

Range: 0000 to 1111

*RST value: 0000

DECT - Radio Fixed Traffic Bearer with Z Field Timeslot B Field

```
[ :SOURce ]:RADio:DECT:RFPart:SLOT0|[1]|2|3|4|5|6|7|8|9|10|11:ZTRaffic[:B]:  
FIX4 <0-15>
```

```
[ :SOURce ]:RADio:DECT:RFPart:SLOT0|[1]|2|3|4|5|6|7|8|9|10|11:ZTRaffic[:B]:  
FIX4?
```

This command enables you to select a binary, 4-bit repeating sequence data pattern to be used in the selected radio fixed part traffic bearer with Z field timeslot B field. `FIX4` must already be defined as the data type.

Range: 0000 to 1111

*RST value: 0000

EDGE - Unframed Data Transmission

```
[ :SOURce ]:RADio:EDGE:DATA:FIX4 <0-15>
```

```
[ :SOURce ]:RADio:EDGE:DATA:FIX4?
```

This command enables you to select a binary, 4-bit repeating sequence data pattern for unframed transmission according to the protocols (modulation type, symbol rate, filter, and burst shape) selected for the EDGE format. `FIX4` must already be defined as the data type.

Range: 0000 to 1111

*RST value: 0000

EDGE - Custom Timeslot

```
[ :SOURce ]:RADio:EDGE:SLOT0|[1]|2|3|4|5|6|7:CUSTom:FIX4 <0-15>
```

```
[ :SOURce ]:RADio:EDGE:SLOT0|[1]|2|3|4|5|6|7:CUSTom:FIX4?
```

This command enables you to select a binary, 4-bit repeating sequence data pattern to be used in the selected custom timeslot. `FIX4` must already be defined as the data type.

Range: 0000 to 1111

*RST value: 0000

EDGE - Normal Timeslot Encryption Field

```
[ :SOURce ]:RADio:EDGE:SLOT0|[1]|2|3|4|5|6|7:NORMAl:ENCRyption:FIX4 <0-15>
```

```
[ :SOURce ]:RADio:EDGE:SLOT0|[1]|2|3|4|5|6|7:NORMAl:ENCRyption:FIX4?
```

This command enables you to select a binary, 4-bit repeating sequence data pattern to be used in the normal encryption data field of the selected timeslot. `FIX4` must already be defined at the data type.

Range: 0000 to 1111

*RST value: 0000

GSM - Unframed Data Transmission

```
[ :SOURce]:RADio:GSM:DATA:FIX4 <0-15>  
[ :SOURce]:RADio:GSM:DATA:FIX4?
```

This command enables you to select a binary, 4-bit repeating sequence data pattern for unframed transmission according to the protocols (modulation type, symbol rate, filter, and burst shape) selected for the GSM format. `FIX4` must already be defined as the data type.

Range: 0000 to 1111

*RST value: 0000

GSM - Access Timeslot Encryption Field

```
[ :SOURce]:RADio:GSM:SLOT0|[1]|2|3|4|5|6|7:ACCess:ENCRyption:FIX4 <0-15>  
[ :SOURce]:RADio:GSM:SLOT0|[1]|2|3|4|5|6|7:ACCess:ENCRyption:FIX4?
```

This command enables you to select a binary, 4-bit repeating sequence data pattern to be used in the selected access timeslot encryption field. `FIX4` must already be defined as the data type.

Range: 0000 to 1111

*RST value: 0000

GSM - Custom Timeslot

```
[ :SOURce]:RADio:GSM:SLOT0|[1]|2|3|4|5|6|7:CUSTom:FIX4 <0-15>  
[ :SOURce]:RADio:GSM:SLOT0|[1]|2|3|4|5|6|7:CUSTom:FIX4?
```

This command enables you to select a binary, 4-bit repeating sequence data pattern to be used in the selected custom timeslot. `FIX4` must already be defined as the data type.

Range: 0000 to 1111

*RST value: 0000

GSM - Normal Timeslot Encryption Field

```
[ :SOURce]:RADio:GSM:SLOT0|[1]|2|3|4|5|6|7:NORMAl:ENCRyption:FIX4 <0-15>  
[ :SOURce]:RADio:GSM:SLOT0|[1]|2|3|4|5|6|7:NORMAl:ENCRyption:FIX4?
```

This command enables you to select a binary, 4-bit repeating sequence data pattern to be used in the selected normal timeslot encryption field. `FIX4` must already be defined as the data type.

Range: 0000 to 1111

*RST value: 0000

GSM - Synchronization Timeslot Encryption Field

```
[ :SOURCE ]:RADio:GSM:SLOT0 [ 1 ] | 2 | 3 | 4 | 5 | 6 | 7:SYNC:ENCRyption:FIX4 <0-15>  
[ :SOURCE ]:RADio:GSM:SLOT0 [ 1 ] | 2 | 3 | 4 | 5 | 6 | 7:SYNC:ENCRyption:FIX4?
```

This command enables you to select a binary, 4-bit repeating sequence data pattern to be used in the selected synchronization timeslot encryption field. `FIX4` must already be defined as the data type.

Range: 0000 to 1111

*RST value: 0000

NADC - Unframed Data Transmission

```
[ :SOURCE ]:RADio[:NADC]:DATA:FIX4 <0-15>  
[ :SOURCE ]:RADio[:NADC]:DATA:FIX4?
```

This command enables you to select a binary, 4-bit repeating sequence data pattern for unframed transmission according to the protocols (modulation type, symbol rate, filter, and burst shape) selected for the NADC format. `FIX4` must already be defined as the data type.

Range: 0000 to 1111

*RST value: 0000

NADC - Downlink Custom Timeslot

```
[ SOURCE ]:RADio[:NADC]:SLOT[ 1 ] | 2 | 3 | 4 | 5 | 6:DCUSTom:FIX4 <0-15>  
[ SOURCE ]:RADio[:NADC]:SLOT[ 1 ] | 2 | 3 | 4 | 5 | 6:DCUSTom:FIX4?
```

This command enables you to select a binary, 4-bit repeating sequence data pattern to be used in the selected downlink custom timeslot. `FIX4` must already be defined as the data type.

Range: 0000 to 1111

*RST value: 0000

NADC - Downlink Traffic Channel Timeslot

```
[ SOURCE ]:RADio[:NADC]:SLOT[ 1 ] | 2 | 3 | 4 | 5 | 6:DTCHannel[:DATA]:FIX4 <0-15>  
[ SOURCE ]:RADio[:NADC]:SLOT[ 1 ] | 2 | 3 | 4 | 5 | 6:DTCHannel[:DATA]:FIX4?
```

This command enables you to select a binary, 4-bit repeating sequence data pattern to be used in the selected downlink traffic channel timeslot. `FIX4` must already be defined as the data type.

Range: 0000 to 1111

*RST value: 0000

NADC - Uplink Custom Timeslot

```
[SOURCE]:RADIO[:NADC]:SLOT[1]|2|3|4|5|6:UCUSTOM:FIX4 <0-15>  
[SOURCE]:RADIO[:NADC]:SLOT[1]|2|3|4|5|6:UCUSTOM:FIX4?
```

This command enables you to select a binary, 4-bit repeating sequence data pattern to be used in the selected uplink custom timeslot. `FIX4` must already be defined as the data type.

Range: 0000 to 1111

*RST value: 0000

NADC - Uplink Traffic Channel Timeslot

```
[SOURCE]:RADIO[:NADC]:SLOT[1]|2|3|4|5|6:UTCHANNEL[:DATA]:FIX4 <0-15>  
[SOURCE]:RADIO[:NADC]:SLOT[1]|2|3|4|5|6:UTCHANNEL[:DATA]:FIX4?
```

This command enables you to select a binary, 4-bit repeating sequence data pattern to be used in the selected uplink traffic channel timeslot. `FIX4` must already be defined as the data type.

Range: 0000 to 1111

*RST value: 0000

PDC - Unframed Data Transmission

```
[ :SOURCE]:RADIO:PDC:DATA:FIX4 <0-15>  
[ :SOURCE]:RADIO:PDC:DATA:FIX4?
```

This command enables you to select a binary, 4-bit repeating sequence data pattern for unframed transmission according to the protocols (modulation type, symbol rate, filter, and burst shape) selected for the PDC format. `FIX4` must already be defined as the data type.

Range: 0000 to 1111

*RST value: 0000

PDC - Downlink Custom Timeslot

```
[ :SOURCE]:RADIO:PDC:SLOT0|[1]|2|3|4|5:DCUSTOM:FIX4 <0-15>  
[ :SOURCE]:RADIO:PDC:SLOT0|[1]|2|3|4|5:DCUSTOM:FIX4?
```

This command enables you to select a binary, 4-bit repeating sequence data pattern to be used in the selected downlink custom timeslot. `FIX4` must already be defined as the data type.

Range: 0000 to 1111

*RST value: 0000

PDC - Downlink Traffic Channel Timeslot

```
[ :SOURCE ] :RADio:PDC:SLOT0 | [ 1 ] | 2 | 3 | 4 | 5 :DTCHannel [ :TCHannel ] :FIX4 <0-15>  
[ :SOURCE ] :RADio:PDC:SLOT0 | [ 1 ] | 2 | 3 | 4 | 5 :DTCHannel [ :TCHannel ] :FIX4?
```

This command enables you to select a binary, 4-bit repeating sequence data pattern to be used in the selected downlink traffic channel timeslot. `FIX4` must already be defined as the data type.

Range: 0000 to 1111

*RST value: 0000

PDC - Uplink Custom Timeslot

```
[ :SOURCE ] :RADio:PDC:SLOT0 | [ 1 ] | 2 | 3 | 4 | 5 :UCUSTom:FIX4 <0-15>  
[ :SOURCE ] :RADio:PDC:SLOT0 | [ 1 ] | 2 | 3 | 4 | 5 :UCUSTom:FIX4?
```

This command enables you to select a binary, 4-bit repeating sequence data pattern to be used in the selected uplink custom timeslot. `FIX4` must already be defined as the data type.

Range: 0000 to 1111

*RST value: 0000

PDC - Uplink Traffic Channel Timeslot

```
[ :SOURCE ] :RADio:PDC:SLOT0 | [ 1 ] | 2 | 3 | 4 | 5 :UTCHannel [ :TCHannel ] :FIX4 <0-15>  
[ :SOURCE ] :RADio:PDC:SLOT0 | [ 1 ] | 2 | 3 | 4 | 5 :UTCHannel [ :TCHannel ] :FIX4?
```

This command enables you to select a binary, 4-bit repeating sequence data pattern to be used in the selected uplink traffic channel timeslot. `FIX4` must already be defined as the data type.

Range: 0000 to 1111

*RST value: 0000

PHS - Unframed Data Transmission

```
[ :SOURCE ] :RADio:PHS:DATA:FIX4 <0-15>  
[ :SOURCE ] :RADio:PHS:DATA:FIX4?
```

This command enables you to select a binary, 4-bit repeating sequence data pattern for unframed transmission according to the protocols (modulation type, symbol rate, filter, and burst shape) selected for the PHS format. `FIX4` must already be defined as the data type.

Range: 0000 to 1111

*RST value: 0000

PHS - Downlink Custom Timeslot

```
[SOURCE]:RADIO:PHS:DLINK:SLOT[1]|2|3|4:CUSTOM FIX4 <0-15>  
[SOURCE]:RADIO:PHS:DLINK:SLOT[1]|2|3|4:CUSTOM:FIX4?
```

This command enables you to select a binary, 4-bit repeating sequence data pattern to be used in the selected downlink custom timeslot. `FIX4` must already be defined as the data type.

Range: 0000 to 1111

*RST value: 0000

PHS - Downlink Traffic Channel Timeslot

```
[SOURCE]:RADIO:PHS:DLINK:SLOT[1]|2|3|4:TChannel[:TChannel]:FIX4 <0-15>  
[SOURCE]:RADIO:PHS:DLINK:SLOT[1]|2|3|4:TChannel[:TChannel]:FIX4?
```

This command enables you to select a binary, 4-bit repeating sequence data pattern to be used in the selected downlink traffic channel timeslot. `FIX4` must already be defined as the data type.

Range: 0000 to 1111

*RST value: 0000

PHS - Uplink Custom Timeslot

```
[SOURCE]:RADIO:PHS:ULINK:SLOT[1]|2|3|4:CUSTOM FIX4 <0-15>  
[SOURCE]:RADIO:PHS:ULINK:SLOT[1]|2|3|4:CUSTOM:FIX4?
```

This command enables you to select a binary, 4-bit repeating sequence data pattern to be used in the selected uplink custom timeslot. `FIX4` must already be defined as the data type.

Range: 0000 to 1111

*RST value: 0000

PHS - Uplink Traffic Channel Timeslot

```
[SOURCE]:RADIO:PHS:ULINK:SLOT[1]|2|3|4:TChannel[:TChannel]:FIX4 <0-15>  
[SOURCE]:RADIO:PHS:ULINK:SLOT[1]|2|3|4:TChannel[:TChannel]:FIX4?
```

This command enables you to select a binary, 4-bit repeating sequence data pattern to be used in the selected uplink traffic channel timeslot. `FIX4` must already be defined as the data type.

Range: 0000 to 1111

*RST value: 0000

TETRA - Unframed Data Transmission

```
[ :SOURCE ] :RADio:TETRA:DATA:FIX4 <0-15>  
[ :SOURCE ] :RADio:TETRA:DATA:FIX4?
```

This command enables you to select a binary, 4-bit repeating sequence data pattern for unframed transmission according to the protocols (modulation type, symbol rate, filter, and burst shape) selected for the TETRA format. `FIX4` must already be defined as the data type.

Range: 0000 to 1111

*RST value: 0000

TETRA - Downlink Continuous Custom Timeslot

```
[ :SOURCE ] :RADio:TETRa:SLOT[1] | 2 | 3 | 4 :DCCustom:FIX4 <0-15>  
[ :SOURCE ] :RADio:TETRa:SLOT[1] | 2 | 3 | 4 :DCCustom:FIX4?
```

This command enables you to select a binary, 4-bit repeating sequence data pattern to be used in the selected downlink continuous custom timeslot. `FIX4` must already be defined as the data type.

Range: 0000 to 1111

*RST value: 0000

TETRA - Downlink Continuous Normal Timeslot

```
[ :SOURCE ] :RADio:TETRa:SLOT[1] | 2 | 3 | 4 :DCNormal[ :DATA ] :FIX4 <0-15>  
[ :SOURCE ] :RADio:TETRa:SLOT[1] | 2 | 3 | 4 :DCNormal[ :DATA ] :FIX4?
```

This command enables you to select a binary, 4-bit repeating sequence data pattern to be used in the selected downlink continuous normal timeslot. `FIX4` must already be defined as the data type.

Range: 0000 to 1111

*RST value: 0000

TETRA - Downlink Continuous Synchronization Timeslot

```
[ :SOURCE ] :RADio:TETRa:SLOT[1] | 2 | 3 | 4 :DCSync[ :DATA ] :FIX4 <0-15>  
[ :SOURCE ] :RADio:TETRa:SLOT[1] | 2 | 3 | 4 :DCSync[ :DATA ] :FIX4?
```

This command enables you to select a binary, 4-bit repeating sequence data pattern to be used in the selected downlink continuous synchronization timeslot. `FIX4` must already be defined as the data type.

Range: 0000 to 1111

*RST value: 0000

TETRA - Downlink Discontinuous Custom Timeslot

```
[ :SOURce]:RADio:TETRa:SLOT[1] | 2 | 3 | 4:DDCustom:FIX4 <0-15>  
[ :SOURce]:RADio:TETRa:SLOT[1] | 2 | 3 | 4:DDCustom:FIX4?
```

This command enables you to select a binary, 4-bit repeating sequence data pattern to be used in the selected downlink discontinuous custom timeslot. FIX4 must already be defined as the data type.

Range: 0000 to 1111

*RST value: 0000

TETRA - Downlink Discontinuous Normal Timeslot

```
[ :SOURce]:RADio:TETRa:SLOT[1] | 2 | 3 | 4:DDNormal:FIX4 <0-15>  
[ :SOURce]:RADio:TETRa:SLOT[1] | 2 | 3 | 4:DDNormal:FIX4?
```

This command enables you to select a binary, 4-bit repeating sequence data pattern to be used in the selected downlink discontinuous normal timeslot. FIX4 must already be defined as the data type.

Range: 0000 to 1111

*RST value: 0000

TETRA - Downlink Discontinuous Synchronization Timeslot

```
[ :SOURce]:RADio:TETRa:SLOT[1] | 2 | 3 | 4:DDSync[:DATA]:FIX4 <0-15>  
[ :SOURce]:RADio:TETRa:SLOT[1] | 2 | 3 | 4:DDSync[:DATA]:FIX4?
```

This command enables you to select a binary, 4-bit repeating sequence data pattern to be used in the selected downlink discontinuous synchronization timeslot. FIX4 must already be defined as the data type.

Range: 0000 to 1111

*RST value: 0000

TETRA - Uplink Control 1 Timeslot

```
[ :SOURce]:RADio:TETRa:SLOT[1] | 2 | 3 | 4:UC1[:DATA]:FIX4 <0-15>  
[ :SOURce]:RADio:TETRa:SLOT[1] | 2 | 3 | 4:UC1[:DATA]:FIX4?
```

This command configures the uplink control 1 data field FIX4 value for the selected timeslot.

Range: 0000 to 1111

*RST value: 0000 (binary)

TETRA - Uplink Control 2 Timeslot

```
[ :SOURce]:RADio:TETRa:SLOT[1] | 2 | 3 | 4:UC2[:DATA]:FIX4 <0-15>  
[ :SOURce]:RADio:TETRa:SLOT[1] | 2 | 3 | 4:UC2[:DATA]:FIX4?
```

This command configures the uplink control 2 data field FIX4 value for the selected timeslot.

Range: 0000 to 1111

*RST value: 0000 (binary)

TETRA - Uplink Custom Timeslot

```
[ :SOURCE ] :RADio:TETRa:SLOT[1] | 2 | 3 | 4 :UCUSTom:FIX4 <0-15>  
[ :SOURCE ] :RADio:TETRa:SLOT[1] | 2 | 3 | 4 :UCUSTom:FIX4?
```

This command enables you to configure the selected uplink custom data field to FIX4 (4-bit repeating sequence data pattern).

Range: 0000 to 1111

*RST value: 0000 (binary)

TETRA - Uplink Normal Timeslot

```
[ :SOURCE ] :RADio:TETRa:SLOT[1] | 2 | 3 | 4 :UNORmal[ :DATA ] :FIX4 <0-15>  
[ :SOURCE ] :RADio:TETRa:SLOT[1] | 2 | 3 | 4 :UNORmal[ :DATA ] :FIX4?
```

This command configures the uplink normal data field FIX4 value for the selected timeslot.

Range: 0000 to 1111

*RST value: 0000 (binary)

Frequency Correction (FCOR) Field

TETRA - Downlink Continuous Synchronization Timeslot

```
[ :SOURCE ] :RADio:TETRa:SLOT[1] | 2 | 3 | 4 :DCSync:FCOR <80-bit value>  
[ :SOURCE ] :RADio:TETRa:SLOT[1] | 2 | 3 | 4 :DCSync:FCOR?
```

This command sets the frequency correction bits for the selected downlink continuous synchronization timeslot.

Range: 00000000000000000000 to FFFFFFFFFFFFFFFFFFFFFFFF

*RST value: FF0000000000000000FF

TETRA - Downlink Discontinuous Synchronization Timeslot

```
[ :SOURCE ] :RADio:TETRa:SLOT[1] | 2 | 3 | 4 :DDSync:FCOR <80-bit value>  
[ :SOURCE ] :RADio:TETRa:SLOT[1] | 2 | 3 | 4 :DDSync:FCOR?
```

This command sets the frequency correction bits for the selected downlink discontinuous synchronization timeslot.

Range: 00000000000000000000 to FFFFFFFFFFFFFFFFFFFFFFFF

*RST value: FF0000000000000000FF

FSK Deviation

See “[Modulation Configuration - Type, User FSK, User I/Q](#)”.

Guard Field

EDGE - Custom Timeslot

```
[ :SOURce]:RADIo:EDGE:SLOT0|[1]|2|3|4|5|6|7:CUSTom:
GUARd <24- or 27-bit pattern>
[ :SOURce]:RADIo:EDGE:SLOT0|[1]|2|3|4|5|6|7:CUSTom:GUARd?
```

EDGE - Normal Timeslot

```
[ :SOURce]:RADIo:EDGE:SLOT0|[1]|2|3|4|5|6|7:NORMAl:
GUARd <24- or 27-bit pattern>
[ :SOURce]:RADIo:EDGE:SLOT0|[1]|2|3|4|5|6|7:NORMAl:GUARd?
```

This command defines the hexadecimal value for the guard time field in each custom or normal timeslot. The guard time field in timeslots 0 and 4 contain 27 bits; the remaining timeslots contain 24 bits.

The guard time field is always modulated (but not bursted), even when the timeslot is off. If the guard time and T2 symbols of the current timeslot and the T1 symbols of the next timeslot do not match, the burst shape may not be smooth (even if the current timeslot is turned off). Use hexadecimal for the value in the SCPI command (precede the value with #H); the signal generator converts it to binary.

Range: 0 through 7FFFFFFF for timeslots 0 and 4
0 through 0FFFFFFF for timeslots 1, 2, 3, 5, 6, and 7

*RST value:

Timeslot #	Guard Time Field (Normal and Custom)
0	7FFFFFFF
1	0FFFFFFF
2	0FFFFFFF
3	0FFFFFFF
4	7FFFFFFF
5	0FFFFFFF
6	0FFFFFFF
7	0FFFFFFF

Idle Field

PHS - Downlink Synchronization Channel Timeslot

```
[SOURce]:RADIo:PHS:DLINK:SLOT[1]|2|3|4:SCHannel:IDLE <bit pattern>
[SOURce]:RADIo:PHS:DLINK:SLOT[1]|2|3|4:SCHannel:IDLE?
```

PHS - Uplink Synchronization Channel Timeslot

```
[SOURce]:RADio:PHS:ULINK:SLOT[1]|2|3|4:SCHannel:IDLE <bit pattern>  
[SOURce]:RADio:PHS:ULINK:SLOT[1]|2|3|4:SCHannel:IDLE?
```

This command enables you to change the 34-bit idle (IDLE) field. The preset hexadecimal value (when normal preset is selected) for IDLE reflects the PHS protocol, however you can enter a new value entering this command. The current value for IDLE is displayed in the IDLE field near the bottom of the text area of the display.

Range: 000000000 to 3FFFFFFF

*RST value: 000000000

I/Q Scaling

Custom

```
[ :SOURce]:RADio:CUSTom:IQ:SCALE <value>  
[ :SOURce]:RADio:CUSTom:IQ:SCALE?
```

Other Formats

```
[ :SOURce]:RADio:<desired format>:IQ:SCALE <value>  
[ :SOURce]:RADio:<desired format>:IQ:SCALE?
```

This command sets the amplitude of the I/Q outputs for better ACP. This command has no effect with MSK or FSK modulation.

Range: 1 through 9999

*RST value: Custom, NADC: 70; All Others: 100%

Leading Broadcast Bit (B1) Field

TETRA - Downlink Continuous Normal Timeslot

```
[ :SOURce]:RADio:TETRa:SLOT[1]|2|3|4:DCNormal:B1 <14-bit value>  
[ :SOURce]:RADio:TETRa:SLOT[1]|2|3|4:DCNormal:B1?
```

This command sets the first 14 broadcast bits for the selected downlink continuous normal timeslot.

Range: 0000 to 101A (hexadecimal)

*RST value: 0000 (hexadecimal)

TETRA - Downlink Discontinuous Normal Timeslot

```
[ :SOURce]:RADio:TETRa:SLOT[1]|2|3|4:DDNormal:B1 <14-bit value>  
[ :SOURce]:RADio:TETRa:SLOT[1]|2|3|4:DDNormal:B1?
```

This command sets the first 14 broadcast bits for the selected downlink discontinuous normal timeslot.

Range: 0000 to 101A (hexadecimal)

*RST value: 0000 (hexadecimal)

Mode State

Custom

```
[ :SOURce]:RADio:CUSTom[:STATe] ON|OFF|1|0  
[:SOURce]:RADio:CUSTom[:STATe]?
```

Other Formats

```
[ :SOURce]:RADio:<desired format>[:STATe] ON|OFF|1|0  
[:SOURce]:RADio:<desired format>[:STATe]?
```

This command toggles the modulation format. Options: ON (1) or OFF (0).

Although the digital modulation is enabled with this command, the RF carrier is modulated by the enabled modulation only when you have also activated the modulation.

*RST value: Off

Modulation Configuration - Type, User FSK, User I/Q

Modulation Type

Custom

```
[ :SOURce]:RADio:CUSTom:MODulation[:TYPE] BPSK|QPSK|IS95QPSK|GRAYQPSK|  
OQPSK|IS95OQPSK|P4DQPSK|PSK8|PSK16|D8PSK|MSK|FSK2|FSK4|FSK8|FSK16|C4FM|  
QAM4|QAM16|QAM32|QAM64|QAM256|UIQ|UFSK  
[:SOURce]:RADio:CUSTom:MODulation[:TYPE]?
```

```
DECT [ :SOURce]:RADio:DECT:MODulation[:TYPE] PSK|BPSK|QPSK|IS95QPSK|  
GRAYQPSK|OQPSK|IS95OQPSK|P4DQPSK|PSK8|PSK16|D8PSK|MSK|FSK2|FSK4|FSK8|  
FSK16|C4FM|QAM4|QAM16|QAM32|QAM64|QAM256|UIQ|UFSK  
[:SOURce]:RADio:DECT:MODulation[:TYPE]?
```

EDGE

```
[ :SOURce]:RADio:EDGE:MODulation[:TYPE] BPSK|QPSK|IS95QPSK|GRAYQPSK|OQPSK|  
IS95OQPSK|P4DQPSK|PSK8|PSK16|D8PSK|MSK|FSK2|FSK4|FSK8|FSK16|C4FM|QAM4|  
QAM16|QAM32|QAM64|QAM256|EDGE|UIQ|UFSK  
[:SOURce]:RADio:EDGE:MODulation[:TYPE]?
```

GSM

```
[ :SOURce]:RADio:GSM:MODulation[:TYPE] BPSK|QPSK|IS95QPSK|GRAYQPSK|OQPSK|  
IS95OQPSK|P4DQPSK|PSK8|PSK16|D8PSK|MSK|FSK2|FSK4|FSK8|FSK16|C4FM|QAM4|  
QAM16|QAM32|QAM64|QAM256|UIQ|UFSK  
[:SOURce]:RADio:GSM:MODulation[:TYPE]?
```

```
NADC [:SOURce]:RADio[:NADC]:MODulation[:TYPE] BPSK|QPSK|IS95QPSK|  
GRAYQPSK|OQPSK|IS95OQPSK|P4DQPSK|PSK8|PSK16|D8PSK|MSK|FSK2|FSK4|FSK8|  
FSK16|C4FM|QAM4|QAM16|QAM32|QAM64|QAM256|UIQ|UFSK  
[:SOURce]:RADio[:NADC]:MODulation[:TYPE]?
```

PDC

```
[:SOURce]:RADio:PDC:MODulation[:TYPE] BPSK|QPSK|IS95QPSK|GRAYQPSK|OQPSK|  
IS95OQPSK|P4DQPSK|PSK8|PSK16|D8PSK|MSK|FSK2|FSK4|FSK8|FSK16|C4FM|QAM4|  
QAM16|QAM32|QAM64|QAM256|UIQ|UFSK  
[:SOURce]:RADio:PDC:MODulation[:TYPE]?
```

PHS

```
[:SOURce]:RADio:PHS:MODulation[:TYPE] BPSK|QPSK|IS95QPSK|GRAYQPSK|OQPSK|  
IS95OQPSK|P4DQPSK|PSK8|PSK16|D8PSK|MSK|FSK2|FSK4|FSK8|FSK16|C4FM|QAM4|  
QAM16|QAM32|QAM64|QAM256|UIQ|UFSK  
[:SOURce]:RADio:PHS:MODulation[:TYPE]?
```

TETRA

```
[:SOURce]:RADio:TETRa:MODulation[:TYPE] BPSK|QPSK|IS95QPSK|GRAYQPSK|OQPSK|  
IS95OQPSK|P4DQPSK|PSK8|PSK16|D8PSK|MSK|FSK2|FSK4|FSK8|FSK16|C4FM|QAM4|  
QAM16|QAM32|QAM64|QAM256|UIQ|UFSK  
[:SOURce]:RADio:TETRa:MODulation[:TYPE]?
```

This command sets the custom modulation to one of the available formats:

BPSK	Binary phase shift keying
QPSK	Quadrature phase shift keying
IS95QPSK	IS95 quadrature phase shift keying
GRAYQPSK	Gray coded quadrature phase shift keying
OQPSK	Offset quadrature phase shift keying
IS95OQPSK	IS95 offset quadrature phase shift keying
π 4DQPSK	$\pi/4$ differential quadrature phase shift keying
PSK8	8-state phase shift keying
PSK16	16-state phase shift keying
D8PSK	Differential 8-state phase shift keying
MSK	Minimum shift keying
FSK2	2-level frequency shift keying
FSK4	4-level frequency shift keying
FSK8	8-level frequency shift keying
FSK16	16-level frequency shift keying
C4FM	APCO 25-compliant, 4-level frequency shift keying

QAM4	4-state quadrature amplitude modulation
QAM8	8-state quadrature amplitude modulation
QAM16	16-state quadrature amplitude modulation
QAM32	32-state quadrature amplitude modulation
QAM64	64-state quadrature amplitude modulation
QAM256	256-state quadrature amplitude modulation
EDGE	$3\pi/8$ rotating 8-state phase shift keying
UIQ	User-defined I/Q modulation
UFSK	User-defined custom frequency shift keying

*RST value:

- Custom, DECT, GSM, NADC, PDC, PHS, TETRA: π 4DQPSK
- EDGE: EDGE

Selecting a Custom FSK Modulation File

```
[ :SOURCE]:RADio:CUSTom:MODulation:UFSK "<file name>"  
[ :SOURCE]:RADio:CUSTom:MODulation:UFSK?  
  
[ :SOURCE]:RADio:<desired format>:MODulation:UFSK "<file name>"  
[ :SOURCE]:RADio:<desired format>:MODulation:UFSK?
```

UFSK "<file name>" defines the prestored FSK file that you want to use.

This information is held in memory until you send the command that selects user FSK as the modulation type:

- **Custom:** [:SOURCE]:RADio:CUSTom:MODulation[:TYPE] UFSK
- **All Others:** [:SOURCE]:RADio:<desired format>:MODulation[:TYPE] UFSK

Selecting a Custom I/Q Modulation File

```
[ :SOURce]:RADio:CUSTom:MODulation:UIQ "<file name>"  
[ :SOURce]:RADio:CUSTom:MODulation:UIQ?  
  
[ :SOURce]:RADio:<desired format>:MODulation:UIQ "<file name>"  
[ :SOURce]:RADio:<desired format>:MODulation:UIQ?
```

UIQ "<file name>" defines the prestored I/Q file that you want to use.

This information is held in memory until you send the command that selects user I/Q as the modulation type:

- **Custom:** [:SOURce]:RADio:CUSTom:MODulation[:TYPE] UIQ
- **All Others:** [:SOURce]:RADio:<desired format>:MODulation[:TYPE] UIQ

Creating a Custom FSK Modulation

```
:MEMory:DATA:FSK "<file name>",<num states>,<f0>,<f1>,...  
[,<diff state>,<num diff states>,<diff0>,<diff1>,...]
```

This command enables you to define and store a custom FSK file.

"<file name>"	The name under which to store the defined FSK information
num states	Number of frequency states (2 through 16)
f0	Value of the first frequency
f1	Value of the second frequency
diff state	Toggle for differential encoding. (ON OFF 1 0)
num diff states	The number of differential states (0 through 256)
diff0	Value of first differential state (an integer value from -128 through +127)
diff1	Value of 2nd differential state (an integer value from -128 through +127)

Example

The following example creates and stores a four-level FSK file named 4FSK that has four states (frequencies) of -2 kHz, -1 kHz, 2 kHz, 1 kHz. Differential encoding is toggled ON, and there are two differential states: 1 and 0.

```
:MEM:DATA:FSK "4FSK",4,-2 kHz,-1 kHz,2 kHz,1 kHz,ON,2,1,0
```

Creating a Custom I/Q Modulation

```
:MEMory:DATA:IQ "<file name>",<offsetQ>,<num states>,<i0>,<q0>,<i1>,<q1>,...  
[,<diff state>,<num diff states>,<diff0>,<diff1>,...]
```

This command enables you to define and store a custom I/Q file.

"<file name>"	The name under which to store the defined I/Q information
offsetQ	Whether the Q output is delayed by 1/2 symbol from the I output (ON OFF 1 0)
num states	Number of symbols (2 through 256)
i0	I value of first symbol (-1 through +1)
q0	Q value of first symbol (-1 through +1)
diff state	Toggle for differential encoding. (ON OFF 1 0)
num diff states	The number of differential states (0 through 256)
diff0	Value of first differential state (an integer value from -128 through +127)
diff1	Value of 2nd differential state (an integer value from -128 through +127)

Example

The following example creates and stores a two-symbol I/Q file named `testBPSK` that has offset Q turned on.

```
:MEM:DATA:IQ "testBPSK",1,2,1,0,0,0
```

FSK Frequency Deviation

```
[ :SOURce]:RADio:CUSTom:MODulation:FSK[:DEVIation] <val><unit>  
[:SOURce]:RADio:CUSTom:MODulation:FSK[:DEVIation]?  
[:SOURce]:RADio:<desired format>:MODulation:FSK[:DEVIation] <val><unit>  
[:SOURce]:RADio:<desired format>:MODulation:FSK[:DEVIation]?
```

This command selects symmetric FSK frequency deviation; to define an asymmetric or different convention than the default, see [“Building a Customized FSK Modulation with the FSK Table Editor”](#) on page 2 -22.

Range: 0 Hz is the minimum value; the maximum value depends upon the symbol rate.

*RST value: 400.0 Hz

MSK Phase Deviation

```
[ :SOURce]:RADio:CUSTom:MODulation:MSK[:PHASe] <val><unit>  
[:SOURce]:RADio:CUSTom:MODulation:MSK[:PHASe]?  
[:SOURce]:RADio:<desired format>:MODulation:MSK[:PHASe] <val><unit>  
[:SOURce]:RADio:<desired format>:MODulation:MSK[:PHASe]?
```

This command selects MSK phase deviation.

Range: 0 to 100 degrees

*RST value: 90.00 degrees

MSK Phase

See [“Modulation Configuration - Type, User FSK, User I/Q”](#).

P Field

DECT - Portable Part Low Capacity Timeslot

```
[ :SOURce]:RADio:DECT:PPart:SLOT0|[1]|2|3|4|5|6|7|8|9|10|11:LCAPacity:  
P <16-bit value>  
[:SOURce]:RADio:DECT:PPart:SLOT0|[1]|2|3|4|5|6|7|8|9|10|11:LCAPacity:P?
```

This command enables you to customize the preamble (P) field of the selected low capacity timeslot in the portable part link.

Range: 0000 to FFFF (hexadecimal)

*RST value: 5555 (hexadecimal)

DECT - Portable Part Low Capacity with Z Field Timeslot

```
[ :SOURce]:RADio:DECT:PPart:SLOT0|[1]|2|3|4|5|6|7|8|9|10|11:ZLCAPacity:  
P <16-bit value>  
[:SOURce]:RADio:DECT:PPart:SLOT0|[1]|2|3|4|5|6|7|8|9|10|11:ZLCAPacity:P?
```

This command enables you to customize the preamble (P) field of the selected low capacity with Z field timeslot in the portable part link.

Range: 0000 to FFFF (hexadecimal)

*RST value: 5555 (hexadecimal)

DECT - Portable Part Traffic Bearer Timeslot

```
[ :SOURce]:RADio:DECT:PPart:SLOT0|[1]|2|3|4|5|6|7|8|9|10|11:TRAffic:  
P <16-bit value>
```

```
[ :SOURce]:RADio:DECT:PPart:SLOT0|[1]|2|3|4|5|6|7|8|9|10|11:TRAffic:P?
```

This command enables you to customize the preamble (P) field of the selected traffic bearer timeslot in the portable part link.

Range: 0000 to FFFF (hexadecimal)

*RST value: 5555 (hexadecimal)

DECT - Portable Part Traffic Bearer with Z Field Timeslot

```
[ :SOURce]:RADio:DECT:PPart:SLOT0|[1]|2|3|4|5|6|7|8|9|10|11:ZTRAffic:  
P <16-bit value>
```

```
[ :SOURce]:RADio:DECT:PPart:SLOT0|[1]|2|3|4|5|6|7|8|9|10|11:ZTRAffic:P?
```

This command enables you to customize the preamble (P) field of the selected traffic bearer with Z field timeslot in the portable part link.

Range: 0000 to FFFF (hexadecimal)

*RST value: 5555 (hexadecimal)

DECT - Radio Fixed Part Dummy Timeslot

```
[ :SOURce]:RADio:DECT:RFPart:SLOT0|[1]|2|3|4|5|6|7|8|9|10|11:DUMM[1]|2:  
P <64-bit value>
```

```
[ :SOURce]:RADio:DECT:RFPart:SLOT0|[1]|2|3|4|5|6|7|8|9|10|11:DUMM[1]|2:P?
```

This command enables you to customize the preamble (P) field for the selected dummy 1 or 2 timeslot in the radio fixed part link.

Range: 0000 to FFFF (hexadecimal)

*RST value: AAAA (hexadecimal)

DECT - Radio Fixed Low Capacity Timeslot

```
[ :SOURce]:RADio:DECT:RFPart:SLOT0|[1]|2|3|4|5|6|7|8|9|10|11:LCAPacity:  
P <16-bit value>
```

```
[ :SOURce]:RADio:DECT:RFPart:SLOT0|[1]|2|3|4|5|6|7|8|9|10|11:LCAPacity:P?
```

This command enables you to customize the preamble (P) field of the selected low capacity timeslot in the radio fixed part link.

Range: 0000 to FFFF (hexadecimal)

*RST value: AAAA (hexadecimal)

DECT - Radio Fixed Low Capacity with Z Field Timeslot

```
[ :SOURce]:RADio:DECT:RFPart:SLOT0|[1]|2|3|4|5|6|7|8|9|10|11:ZLCapacity:  
P <16-bit value>
```

```
[ :SOURce]:RADio:DECT:RFPart:SLOT0|[1]|2|3|4|5|6|7|8|9|10|11:ZLCapacity:P?
```

This command enables you to customize the preamble (P) field of the selected low capacity with Z field timeslot in the radio fixed part link.

Range: 0000 to FFFF (hexadecimal)

*RST value: AAAA (hexadecimal)

DECT - Radio Fixed Traffic Bearer Timeslot

```
[ :SOURce]:RADio:DECT:RFPart:SLOT0|[1]|2|3|4|5|6|7|8|9|10|11:TRAffic:  
P <16-bit value>
```

```
[ :SOURce]:RADio:DECT:RFPart:SLOT0|[1]|2|3|4|5|6|7|8|9|10|11:TRAffic:P?
```

This command enables you to customize the preamble (P) field of the selected traffic bearer timeslot in the radio fixed part link.

Range: 0000 to FFFF (hexadecimal)

*RST value: AAAA (hexadecimal)

DECT - Radio Fixed Traffic Bearer with Z Field Timeslot

```
[ :SOURce]:RADio:DECT:RFPart:SLOT0|[1]|2|3|4|5|6|7|8|9|10|11:ZTRAffic:  
P <16-bit value>
```

```
[ :SOURce]:RADio:DECT:RFPart:SLOT0|[1]|2|3|4|5|6|7|8|9|10|11:ZTRAffic:P?
```

This command enables you to customize the preamble (P) field of the selected traffic bearer with Z field timeslot in the radio fixed part link.

Range: 0000 to FFFF (hexadecimal)

*RST value: AAAA (hexadecimal)

Multiframe PN Sequence

EDGE

```
[ :SOURce]:RADio:EDGE:SLOT0|[1]|2|3|4|5|6|7:NORMAl:ENCRyption PN9|PN15|  
FIX4|"file name"|EXT|P4|P8|P16|P32|P64|DMCS9|UMCS9|DMCS5|UMCS5|  
ETCHF43|UNCOded  
[ :SOURce]:RADio:EDGE:SLOT0|[1]|2|3|4|5|6|7:NORMAl:ENCRyption?
```

This command selects the EDGE channel type. No more than 4 timeslots can be enabled. Multiframe channels are encryption data type.

DMCS9: EGPRS MCS-9 downlink channel

UMCS9: EGPRS MCS-9 uplink channel

DMCS5: EGPRS MCS-5 downlink channel

UMCS5: EGPRS MCS-5 uplink channel

ETCH:F43: E-TCH/F43 channel

UNCoded: No channel coding, multiframe channel (every 13th frame is off).

***RST Value:** PN9

```
[ :SOURce]:RADio:EDGE:SLOT0|[1]|2|3|4|5|6|7:NORMal:ENCRyption:  
UNCoded PN9|PN15  
[ :SOURce]:RADio:EDGE:SLOT0|[1]|2|3|4|5|6|7:NORMal:ENCRyption:UNCoded?
```

This command selects the data type for the uncoded multiframe channel.

```
[ :SOURce]:RADio:EDGE:SLOT0|[1]|2|3|4|5|6|7:NORMal:ENCRyption:DLINK:MCS9:  
DATA PN9|PN15  
[ :SOURce]:RADio:EDGE:SLOT0|[1]|2|3|4|5|6|7:NORMal:ENCRyption:DLINK:MCS9:  
DATA?
```

This command selects the data type for the EGPRS MCS-9 downlink channel.

***RST Value:** PN9

```
[ :SOURce]:RADio:EDGE:SLOT0|[1]|2|3|4|5|6|7:NORMal:ENCRyption:ULINK:MCS9:  
DATA PN9|PN15  
[ :SOURce]:RADio:EDGE:SLOT0|[1]|2|3|4|5|6|7:NORMal:ENCRyption:ULINK:MCS9:  
DATA?
```

This command selects the data type for the EGPRS MCS-9 uplink channel.

***RST Value:** PN9

```
[ :SOURce]:RADio:EDGE:SLOT0|[1]|2|3|4|5|6|7:NORMal:ENCRyption:DLINK:MCS5:  
DATA PN9|PN15  
[ :SOURce]:RADio:EDGE:SLOT0|[1]|2|3|4|5|6|7:NORMal:ENCRyption:DLINK:MCS5:  
DATA?
```

This command selects the data type for the EGPRS MCS-5 downlink channel.

***RST Value:** PN9

```
[ :SOURce]:RADio:EDGE:SLOT0|[1]|2|3|4|5|6|7:NORMal:ENCRyption:ULINK:MCS5:  
DATA PN9|PN15  
[ :SOURce]:RADio:EDGE:SLOT0|[1]|2|3|4|5|6|7:NORMal:ENCRyption:ULINK:MCS5:  
DATA?
```

This command selects the data type for the EGPRS MCS-5 uplink channel.

***RST Value:** PN9

```
[ :SOURce]:RADio:EDGE:SLOT0|[1]|2|3|4|5|6|7:NORMal:ENCRyption:ETCH:F43:  
DATA PN9|PN15  
[ :SOURce]:RADio:EDGE:SLOT0|[1]|2|3|4|5|6|7:NORMal:ENCRyption:ETCH:F43:  
DATA?
```

This command selects the data type for the E-TCH/F43.2 channel.

***RST Value:** PN9

GSM

```
[ :SOURCE ] :RADio:GSM:SLOT0 | [ 1 ] | 2 | 3 | 4 | 5 | 6 | 7 :NORMal:ENCRyption PN9 | PN15 |  
FIX4 | "file name" | EXT | P4 | P8 | P16 | P32 | P64 | MPN9 | MPN15 | TCHFS | CS1 |  
CS4 | DMCS1 | UMCS1  
[ :SOURCE ] :RADio:GSM:SLOT0 | [ 1 ] | 2 | 3 | 4 | 5 | 6 | 7 :NORMal:ENCRyption?
```

This command turns on a 26-TCH multiframe pattern and embeds the specified sequence in the selected timeslot. You can enable any or all of the 8 timeslots.

*RST Value: PN9

Personal Station ID Code

PHS - Downlink Synchronization Channel Timeslot

```
[ SOURCE ] :RADio:PHS:DLINK:SLOT[ 1 ] | 2 | 3 | 4 :SCHannel:PSID <bit pattern>  
[ SOURCE ] :RADio:PHS:DLINK:SLOT[ 1 ] | 2 | 3 | 4 :SCHannel:PSID?
```

PHS - Uplink Synchronization Channel Timeslot

```
[ SOURCE ] :RADio:PHS:ULINK:SLOT[ 1 ] | 2 | 3 | 4 :SCHannel:PSID <bit pattern>  
[ SOURCE ] :RADio:PHS:ULINK:SLOT[ 1 ] | 2 | 3 | 4 :SCHannel:PSID?
```

This command enables you to change the 28-bit personal station identification code (PSID) field in the synchronization channel. The preset hexadecimal value (when normal preset is selected) for PSID reflects the PHS protocol, however you can enter a new value entering this command. The current value for PSID is displayed in the PSID field near the bottom of the text area of the display.

*RST value: 0000001

Phase Polarity

Custom

```
[ :SOURCE ] :RADio:CUSTom:POLarity[ :ALL ] NORMal | INVerted  
[ :SOURCE ] :RADio:CUSTom:POLarity[ :ALL ]?
```

Other Formats

```
[ :SOURCE ] :RADio:<desired format>:POLarity[ :ALL ] NORMal | INVerted  
[ :SOURCE ] :RADio:<desired format>:POLarity[ :ALL ]?
```

This command sets the direction of rotation of the phase modulation vector:

Normal	Normal phase polarity.
Inverted	The in-phase component will lag the quadrature-phase component by 90° in the resulting modulation. The inverted selection also applies to the I OUT and Q OUT signals.

*RST value: DECT: inverted; All Others: normal

PN9 Mode

See “[Burst Configuration - State, Type, Rise/Fall Time, Rise/Fall Delay, PN9 Mode](#)”.

Predefined Mode

Custom

```
[ :SOURCE ] : RADIo : CUSTom : STANdard : SElect NONE | AC4Fm | ACQPsk | BLUEtooth | CDPD  
[ :SOURCE ] : RADIo : CUSTom : STANdard : SElect ?
```

This command enables you to set up Custom with the appropriate defaults for the available formats:

NONE	Custom is no longer set to the appropriate defaults for a particular format
AC4FM	APCO 25-compliant, compatible 4-level frequency shift keying
ACQPsk	APCO 25-compliant, compatible quadrature phase shift keying
BLUEtooth	Bluetooth uses 2-level frequency shift keying
CDPD	CDPD uses minimum shift keying

S Field

DECT - Portable Part Low Capacity Timeslot

```
[ :SOURCE ] : RADIo : DECT : PPart : SLoT0 | [ 1 ] | 2 | 3 | 4 | 5 | 6 | 7 | 8 | 9 | 10 | 11 : LCApacity :  
S <16-bit value>
```

```
[ :SOURCE ] : RADIo : DECT : PPart : SLoT0 | [ 1 ] | 2 | 3 | 4 | 5 | 6 | 7 | 8 | 9 | 10 | 11 : LCApacity : S ?
```

This command enables you to customize the synchronization pattern of the selected low capacity timeslot in the portable part link.

Range: 0000 to FFFF (hexadecimal)

*RST value: 1675 (hexadecimal)

DECT - Portable Part Low Capacity with Z Field Timeslot

```
[ :SOURCE ] : RADIo : DECT : PPart : SLoT0 | [ 1 ] | 2 | 3 | 4 | 5 | 6 | 7 | 8 | 9 | 10 | 11 : ZLCApacity :  
S <16-bit value>
```

```
[ :SOURCE ] : RADIo : DECT : PPart : SLoT0 | [ 1 ] | 2 | 3 | 4 | 5 | 6 | 7 | 8 | 9 | 10 | 11 : ZLCApacity : S ?
```

This command enables you to customize the synchronization pattern of the selected low capacity with Z field timeslot in the portable part link.

Range: 0000 to FFFF (hexadecimal)

*RST value: 1675 (hexadecimal)

DECT - Portable Part Traffic Bearer Timeslot

```
[ :SOURCE ] : RADIo : DECT : PPart : SLoT0 | [ 1 ] | 2 | 3 | 4 | 5 | 6 | 7 | 8 | 9 | 10 | 11 : TRAFfic :  
S <16-bit value>
```

```
[ :SOURCE ] : RADIo : DECT : PPart : SLoT0 | [ 1 ] | 2 | 3 | 4 | 5 | 6 | 7 | 8 | 9 | 10 | 11 : TRAFfic : S ?
```

This command sets the synchronization pattern for the selected traffic bearer timeslot in the portable part link.

Range: 0000 to FFFF (hexadecimal)

*RST value: 1675 (hexadecimal)

DECT - Portable Part Traffic Bearer with Z Field Timeslot

```
[ :SOURce]:RADio:DECT:PPart:SLOT0|[1]|2|3|4|5|6|7|8|9|10|11:ZTRaffic:  
S <16-bit value>
```

```
[ :SOURce]:RADio:DECT:PPart:SLOT0|[1]|2|3|4|5|6|7|8|9|10|11:ZTRaffic:S?
```

This command sets the synchronization pattern for the selected traffic bearer with Z field timeslot in the portable part link.

Range: 0000 to FFFF (hexadecimal)

*RST value: 1675 (hexadecimal)

DECT - Radio Fixed Part Dummy Bearer Timeslots

```
[ :SOURce]:RADio:DECT:RFPart:SLOT0|[1]|2|3|4|5|6|7|8|9|10|11:DUMM[1]|2:  
S <16-bit value>
```

```
[ :SOURce]:RADio:DECT:RFPart:SLOT0|[1]|2|3|4|5|6|7|8|9|10|11:DUMM[1]|2:S?
```

This command enables you to customize the synchronization (S) field of the selected dummy (1 or 2) timeslot in the radio fixed part link.

Range: 0000 to FFFF (hexadecimal)

*RST value: E98A (hexadecimal)

DECT - Radio Fixed Part Low Capacity Timeslot

```
[ :SOURce]:RADio:DECT:RFPart:SLOT0|[1]|2|3|4|5|6|7|8|9|10|11:LCAPacity:  
S <16-bit value>
```

```
[ :SOURce]:RADio:DECT:RFPart:SLOT0|[1]|2|3|4|5|6|7|8|9|10|11:LCAPacity:S?
```

This command enables you to customize the synchronization (S) field of the selected low capacity timeslot in the radio fixed part link.

Range: 0000 to FFFF (hexadecimal)

*RST value: E98A (hexadecimal)

DECT - Radio Fixed Part Low Capacity with Z Field Timeslot

```
[ :SOURce]:RADio:DECT:RFPart:SLOT0|[1]|2|3|4|5|6|7|8|9|10|11:ZLCAPacity:  
S <16-bit value>
```

```
[ :SOURce]:RADio:DECT:RFPart:SLOT0|[1]|2|3|4|5|6|7|8|9|10|11:ZLCAPacity:S?
```

This command enables you to customize the synchronization (S) field of the selected low capacity with Z field timeslot in the radio fixed part link.

Range: 0000 to FFFF (hexadecimal)

*RST value: E98A (hexadecimal)

DECT - Radio Fixed Part Traffic Bearer Timeslot

```
[ :SOURce]:RADio:DECT:RFPart:SLOT0 | [1] | 2 | 3 | 4 | 5 | 6 | 7 | 8 | 9 | 10 | 11 :TRAFfic:  
S <16-bit value>
```

```
[ :SOURce]:RADio:DECT:RFPart:SLOT0 | [1] | 2 | 3 | 4 | 5 | 6 | 7 | 8 | 9 | 10 | 11 :TRAFfic:S?
```

This command enables you to customize the synchronization (S) field of the selected traffic bearer timeslot in the radio fixed part link.

Range: 0000 to FFFF (hexadecimal)

*RST value: E98A (hexadecimal)

DECT - Radio Fixed Part Traffic Bearer with Z Field Timeslot

```
[ :SOURce]:RADio:DECT:RFPart:SLOT0 | [1] | 2 | 3 | 4 | 5 | 6 | 7 | 8 | 9 | 10 | 11 :ZTRAffic:  
S <16-bit value>
```

```
[ :SOURce]:RADio:DECT:RFPart:SLOT0 | [1] | 2 | 3 | 4 | 5 | 6 | 7 | 8 | 9 | 10 | 11 :ZTRAffic:S?
```

This command enables you to customize the synchronization (S) field of the selected traffic bearer with Z field timeslot in the radio fixed part link.

Range: 0000 to FFFF (hexadecimal)

*RST value: E98A (hexadecimal)

Scramble Configuration - Seed and State

Scramble Seed

PHS

```
[SOURce]:RADio:PHS:BURSt:SCRamble:SEED <16-bit value>  
[SOURce]:RADio:PHS:BURSt:SCRamble:SEED?
```

TETRA

```
[ :SOURce]:RADio:TETRA:BURSt:SCRamble:SEED <32-bit value>  
[ :SOURce]:RADio:TETRA:BURSt:SCRamble:SEED?
```

This command enables you to select a 16-bit scramble seed for PHS format or a 32-bit scramble seed for TETRA format.

Range: PHS: 000 to 3FF; TETRA: 00000000 to FFFFFFFF

*RST value: PHS: 3FF; TETRA: FFFFFFFF

Scramble State

```
[SOURce]:RADio:PHS | TETRA:BURSt:SCRamble[:STATE] ON | OFF | 1 | 0  
[SOURce]:RADio:PHS | TETRA:BURSt:SCRamble[:STATE]?
```

This command selects the operating state of the scramble feature: On (1) and Off (0). When the scramble capability is activated, data on the related fields will be scrambled using the seed setting.

*RST value: Off

Secondary Frame Configuration - Recall, Save, Trigger, State

Recall Secondary Frame

```
[ :SOURce ]:RADio:<desired format>:SECondary:RECall
```

This command recalls the secondary frame instrument state, overwriting the current instrument state.

Save Secondary Frame

```
[ :SOURce ]:RADio:<desired format>:SECondary:SAVE
```

This command saves the current instrument state as the instrument state to use to generate the secondary frame pattern when the secondary frame state is activated. The file is saved under the name <FORMAT>_SECONDARY_FRAME.

Secondary Frame Trigger Source

```
[ :SOURce ]:RADio:<desired format>:SECondary:TRIGger[ :SOURce ] KEY|EXT|BUS  
[ :SOURce ]:RADio:<desired format>:SECondary:TRIGger[ :SOURce ]?
```

This command selects the type of triggering for the secondary frame. The choices are Key (trigger using the front panel **Trigger** key), Ext (trigger using an external trigger supplied to the TRIGGER IN connector), or Bus (trigger with a command sent over GPIB).

*RST value: Key

Secondary Frame State

```
[ :SOURce ]:RADio:<desired format>:SECondary[ :STATE ] ON|OFF|1|0  
[ :SOURce ]:RADio:<desired format>:SECondary[ :STATE ]?
```

This command enables and disables the secondary frame function. The choices are On (1) or Off (0).

*RST value: Off

Slow Associated Control Channel (SACCH) Field

NADC - Downlink Traffic Channel Timeslot

```
[SOURce]:RADIo[:NADC]:SLOT[1]|2|3|4|5|6:DTCHannel:  
SACChannel <15-bit pattern>  
[SOURce]:RADIo[:NADC]:SLOT[1]|2|3|4|5|6:DTCHannel:SACChannel?
```

This command changes the 15-bit slow associated control channel. The preset hexadecimal value (when normal preset is selected) for SACCH reflects the value specified by the standard.

Range: 000 to FFF (hexadecimal)

*RST value: 000 (hexadecimal)

NADC - Uplink Traffic Channel Timeslot

```
[SOURce]:RADIo[:NADC]:SLOT[1]|2|3|4|5|6:UTCHannel:  
SACChannel <15-bit pattern>  
[SOURce]:RADIo[:NADC]:SLOT[1]|2|3|4|5|6:UTCHannel:SACChannel?
```

This command changes the 15-bit slow associated control channel. The preset hexadecimal value (when normal preset is selected) for SACCH reflects the value specified by the standard.

Range: 000 to FFF (hexadecimal)

*RST value: 000 (hexadecimal)

PDC - Downlink Traffic Channel Timeslot

```
[ :SOURce]:RADIo:PDC:SLOT0|[1]|2|3|4|5:DTCHannel:SACChannel <bit pattern>  
[ :SOURce]:RADIo:PDC:SLOT0|[1]|2|3|4|5:DTCHannel:SACChannel?
```

This command enables you to change the 15-bit slow associated control channel (SACCH). The preset hexadecimal value (when normal preset is selected) for SACCH reflects the PDC protocol, however you can enter a new value by executing this command. Afterwards, the current value for SACCH is displayed in the SACCH field near the bottom of the text area of the display.

Range: 00000 to 1FFFFFF (hexadecimal)

*RST value: 00000 (hexadecimal)

PDC - Uplink Traffic Channel Timeslot

```
[ :SOURce]:RADio:PDC:SLOT0|[1]|2|3|4|5:UTCHannel:SACChannel <bit pattern>  
[ :SOURce]:RADio:PDC:SLOT0|[1]|2|3|4|5:UTCHannel:SACChannel?
```

This command enables you to change the 15-bit slow associated control channel (SACCH). The preset hexadecimal value (when normal preset is selected) for SACCH reflects the PDC protocol, however you can enter a new value by executing this command. Afterwards, the current value for SACCH is displayed in the SACCH field near the bottom of the text area of the display.

Range: 0000 to 7FFF (hexadecimal)

*RST value: 0000 (hexadecimal)

PDC - Uplink VOX Timeslot

```
[ :SOURce]:RADio:PDC:SLOT0|[1]|2|3|4|5:UVOX:SACChannel <bit pattern>  
[ :SOURce]:RADio:PDC:SLOT0|[1]|2|3|4|5:UVOX:SACChannel?
```

This command enables you to change the 15-bit slow associated control channel (SACCH). The preset hexadecimal value (when normal preset is selected) for SACCH reflects the PDC protocol, however you can enter a new value by executing this command. Afterwards, the current value for SACCH is displayed in the SACCH field near the bottom of the text area of the display.

Range: 0000 to 7FFF (hexadecimal)

*RST value: 0000 (hexadecimal)

PHS - Downlink Traffic Channel Timeslot

```
[SOURce]:RADio:PHS:DLINK:SLOT[1]|2|3|4:TCHannel:SACChannel <bit pattern>  
[SOURce]:RADio:PHS:DLINK:SLOT[1]|2|3|4:TCHannel:SACChannel?
```

This command changes the 15-bit slow associated control channel. The preset hexadecimal value (when normal preset is selected) for SACCH reflects the value specified by the standard.

Range: 0000 to FFFF (hexadecimal)

*RST value: 8000 (hexadecimal)

PHS - Uplink Traffic Channel Timeslot

```
[SOURce]:RADio:PHS:ULINK:SLOT[1]|2|3|4:TCHannel:SACChannel <bit pattern>  
[SOURce]:RADio:PHS:ULINK:SLOT[1]|2|3|4:TCHannel:SACChannel?
```

This command changes the 15-bit slow associated control channel. The preset hexadecimal value (when normal preset is selected) for SACCH reflects the value specified by the standard.

Range: 0000 to FFFF (hexadecimal)

*RST value: 8000 (hexadecimal)

Steal Bit

```
[ :SOURce]:RADio:GSM:SLOT0|[1]|2|3|4|5|6|7:NORMal:STeal <1 bit_pattern>  
[ :SOURce]:RADio:GSM:SLOT0|[1]|2|3|4|5|6|7:NORMal:STeal?
```

This command enables you to specify the normal steal bits for the selected timeslot. The single bit defines the value for both 1-bit fields.

Range: 0 to 1

*RST value: 0

Symbol Rate

```
[ :SOURce]:RADio:CUSTom:SRATe <value>  
[ :SOURce]:RADio:CUSTom:SRATe?  
[ :SOURce]:RADio:CUSTom:BRATe <value>  
[ :SOURce]:RADio:CUSTom:BRATe?  
  
[ :SOURce]:RADio:<desired format>:SRATe <value>  
[ :SOURce]:RADio:<desired format>:SRATe?  
[ :SOURce]:RADio:<desired format>1:BRATe <value>  
[ :SOURce]:RADio:<desired format>1:BRATe?
```

¹All formats except EDGE

This command sets the transmission symbol rate.

NOTE The BRATe SCPI command sets the bit rate. The bit rate is adjusted to reflect symbol rate dependent on the number of bits per symbol for the modulation type.

Range: 47.684 sps through 12.5 Msps, depending on the modulation type.

*RST value:

- Custom: 24.300000 ksps
- DECT: 1.152000 Msps
- EDGE: 270.833333 ksps
- GSM: 270.833333 ksps
- NADC: 24.300 ksps
- PDC: 21.00000 ksps
- PHS: 192.000 ksps
- TETRA: 18.000 ksps

Sync Output Configuration - Type, Timeslot, Offset

Synchronization Output Type

```
[ :SOURce]:RADio:<desired format>:SOUT FRAME|SLOT|ALL  
[ :SOURce]:RADio:<desired format>:SOUT?
```

This command sets the type of output at the EVENT 1 connector. The choices are:

FRAME Outputs a 1-bit signal to the EVENT 1 rear panel connector that is

	synchronized to the bit selected by the synchronization output offset of a framed data pattern.
SLOT	Outputs a 1-bit signal to the EVENT 1 rear panel connector that is synchronized to the bit selected by the synchronization output offset of a selected timeslot.
ALL	Outputs a 1-bit signal to the EVENT 1 rear panel connector that is synchronized to the bit selected by the synchronization output offset of each timeslot in a frame.

*RST value: Frame

Synchronization Output Offset

```
[ :SOURce ]:RADio:<desired format>:SOUT:OFFSet <value>  
[ :SOURce ]:RADio:<desired format>:SOUT:OFFSet?
```

This command moves the synchronization signal forward or back from the beginning of the data frame or timeslot.

Range:

- DECT, EDGE, GSM: -155 through +155 bits
- NADC: -323 through +323 bits
- PDC: -279 through +279 bits
- PHS: -239 through +239 bits
- TETRA: -509 through +509 bits

*RST value: 0 bits

Synchronization Output Timeslot

```
[ :SOURce]:RADio:<desired format>:SOUT:SLOT <value>  
[ :SOURce]:RADio:<desired format>:SOUT:SLOT?
```

This command selects the timeslot that will trigger a 1-bit signal at the EVENT 1 OUTPUT connector.

Range:

- DECT: 0 through 11
- EDGE/GSM: 0 through 7
- NADC: 1 through 6
- PDC: 0 through 5
- PHS/TETRA: 1 through 4

*RST value: 0 bits

Synchronization Block Bits (SSB) Field

TETRA - Downlink Continuous Synchronization Timeslot

```
[ :SOURce]:RADio:TETRa:SLOT[1] | 2 | 3 | 4:DCSync:SSB <120-bit value>  
[ :SOURce]:RADio:TETRa:SLOT[1] | 2 | 3 | 4:DCSync:SSB?
```

This command sets the synchronization block bits for the selected downlink synchronization continuous timeslot.

Range: 00000000000000000000000000000000 to FFFFFFFFFFFFFFFFFFFFFFFFFFFFFFFF

*RST value: 00000000000000000000000000000000

TETRA - Downlink Discontinuous Synchronization Timeslot

```
[ :SOURce]:RADio:TETRa:SLOT[1] | 2 | 3 | 4:DDSync:SSB <120-bit value>  
[ :SOURce]:RADio:TETRa:SLOT[1] | 2 | 3 | 4:DDSync:SSB?
```

This command sets the synchronization block bits for the selected downlink synchronization discontinuous timeslot.

Range: 00000000000000000000000000000000 to FFFFFFFFFFFFFFFFFFFFFFFFFFFFFFFF

*RST value: 00000000000000000000000000000000

Synchronization Sequence Field

```
[ :SOURce]:RADio:GSM:SLOT0 | [1] | 2 | 3 | 4 | 5 | 6 | 7:ACcEss:SSEquence <bit_pattern>  
[ :SOURce]:RADio:GSM:SLOT0 | [1] | 2 | 3 | 4 | 5 | 6 | 7:ACcEss:SSEquence?
```

This command specifies the synchronization sequence bits (41 bits) for the selected access timeslot.

Range: 0000000000 to 1FFFFFFFFF

*RST value: 096FF335478

Synchronization Training Sequence Bits (STS) Field

TETRA - Downlink Continuous Synchronization Timeslot

```
[ :SOURce]:RADio:TETRa:SLOT[1] | 2 | 3 | 4:DCSync:STS <38-bit value>  
[ :SOURce]:RADio:TETRa:SLOT[1] | 2 | 3 | 4:DCSync:STS?
```

This command sets the synchronization training sequence for the selected downlink continuous synchronization timeslot.

Range: 000000000 to 3FFFFFFF

*RST value: 30673A7067

TETRA - Downlink Discontinuous Synchronization Timeslot

```
[ :SOURce]:RADio:TETRa:SLOT[1] | 2 | 3 | 4:DDSync:STS <38-bit value>  
[ :SOURce]:RADio:TETRa:SLOT[1] | 2 | 3 | 4:DDSync:STS?
```

This command sets the synchronization training sequence for the selected downlink discontinuous synchronization timeslot.

*RST value: 30673A7067

Synchronization Word Field

NADC - Downlink Traffic Channel Timeslot

```
[SOURce]:RADio[:NADC]:SLOT[1] | 2 | 3 | 4 | 5 | 6:DTCHannel:SWORd <28-bit pattern>  
[SOURce]:RADio[:NADC]:SLOT[1] | 2 | 3 | 4 | 5 | 6:DTCHannel:SWORd?
```

NADC - Uplink Traffic Channel Timeslot

```
[SOURce]:RADio[:NADC]:SLOT[1] | 2 | 3 | 4 | 5 | 6:UTCHannel:SWORd <28-bit pattern>  
[SOURce]:RADio[:NADC]:SLOT[1] | 2 | 3 | 4 | 5 | 6:UTCHannel:SWORd?
```

Range: 0000000 to FFFFFFF

*RST Value: A91DE4A

PDC Downlink Traffic Channel Timeslot

```
[ :SOURce]:RADio:PDC:SLOT0 | [1] | 2 | 3 | 4 | 5:DTCHannel:SWORd <bit pattern>  
[ :SOURce]:RADio:PDC:SLOT0 | [1] | 2 | 3 | 4 | 5:DTCHannel:SWORd?
```

PDC Uplink Traffic Channel Timeslot

```
[ :SOURce]:RADio:PDC:SLOT0 | [1] | 2 | 3 | 4 | 5:UTCHannel:SWORd <bit pattern>  
[ :SOURce]:RADio:PDC:SLOT0 | [1] | 2 | 3 | 4 | 5:UTCHannel:SWORd?
```

PDC UVOX Channel Timeslot

```
[ :SOURCE]:RADIO:PDC:SLOT0|[1]|2|3|4|5:UVOX:SWORd <bit pattern>  
[ :SOURCE]:RADIO:PDC:SLOT0|[1]|2|3|4|5:UVOX:SWORd?
```

This command changes the synchronization word, which is used for slot synchronization, equalizer training, and timeslot identification. The *RST hexadecimal value reflects the value specified by the indicated standard.

Range: 00000 to FFFFF

*RST values: 785B4 (UTCH and UVOX), 87A4B (DTCH)

Tail (T1, T2) Fields

```
[ :SOURCE]:RADIO:EDGE:SLOT0|[1]|2|3|4|5|6|7:NORMAL:T1 <9-bit pattern>  
[ :SOURCE]:RADIO:EDGE:SLOT0|[1]|2|3|4|5|6|7:NORMAL:T1?  
[ :SOURCE]:RADIO:EDGE:SLOT0|[1]|2|3|4|5|6|7:NORMAL:T2 <9-bit pattern>  
[ :SOURCE]:RADIO:EDGE:SLOT0|[1]|2|3|4|5|6|7:NORMAL:T2?
```

This command enables you to define the binary value for both of the 9-bit tail fields in each normal timeslot. Use hexadecimal for the value in the SCPI command (precede the value with #H); the signal generator will convert it to binary.

Range: 0 through 1FF

*RST value: 1FF

Timeslot Configuration - Amplitude, State, Type

Timeslot Amplitude

DECT - Portable Part Timeslots

```
[ :SOURCE]:RADIO:DECT:PPart:SLOT0|[1]|2|3|4|5|6|7|8|9|10|11:POWER MAIN|  
DELTA  
[ :SOURCE]:RADIO:DECT:PPart:SLOT0|[1]|2|3|4|5|6|7|8|9|10|11:POWER?
```

This command toggles the selected timeslot RF output power as main or alternate (delta). This feature is only available with the Alternate Power Control Option UNA.

*RST value: Main

DECT - Radio Fixed Part Timeslots

```
[ :SOURCE]:RADIO:DECT:RFPart:SLOT0|[1]|2|3|4|5|6|7|8|9|10|11:POWER MAIN|  
DELTA  
[ :SOURCE]:RADIO:DECT:RFPart:SLOT0|[1]|2|3|4|5|6|7|8|9|10|11:POWER?
```

This command toggles the selected timeslot RF output power as main or alternate (delta). This feature is only available with the Alternate Power Control Option UNA.

*RST value: Main

EDGE

```
[ :SOURCE]:RADio:EDGE:SLOT0|[1]|2|3|4|5|6|7:POWer MAIN|DELTA  
[ :SOURCE]:RADio:EDGE:SLOT0|[1]|2|3|4|5|6|7:POWer?
```

This command toggles the selected timeslot RF output power as main or alternate (delta). This feature is only available with the Alternate Power Control Option UNA.

*RST value: Main

GSM

```
[ :SOURCE]:RADio:GSM:SLOT0|[1]|2|3|4|5|6|7:POWer MAIN|DELTA  
[ :SOURCE]:RADio:GSM:SLOT0|[1]|2|3|4|5|6|7:POWer?
```

This command toggles the selected timeslot RF output power as main or alternate (delta). This feature is only available with the Alternate Power Control Option UNA.

*RST value: Main

NADC

```
[SOURCE]:RADio[:NADC]:SLOT[1]|2|3|4|5|6:POWer MAIN|DELTA  
[SOURCE]:RADio[:NADC]:SLOT[1]|2|3|4|5|6:POWer?
```

This command toggles the selected timeslot RF output power as main or alternate (delta). This feature is only available with the Alternate Power Control Option UNA.

*RST value: Main

PDC

```
[ :SOURCE]:RADio:PDC:SLOT0|[1]|2|3|4|5:POWer MAIN|DELTA  
[ :SOURCE]:RADio:PDC:SLOT0|[1]|2|3|4|5:POWer?
```

This command toggles the selected timeslot RF output power as main or alternate (delta). This feature is only available with the Alternate Power Control Option UNA.

*RST value: Main

PHS - Downlink Timeslots

```
[SOURCE]:RADio:PHS:DLINK:SLOT[1]|2|3|4:POWer MAIN|DELTA  
[SOURCE]:RADio:PHS:DLINK:SLOT[1]|2|3|4:POWer?
```

This command toggles the selected timeslot RF output power as main or alternate (delta). This feature is only available with the Alternate Power Control Option UNA.

*RST value: Main

PHS - Uplink Timeslots

```
[SOURCE]:RADio:PHS:ULINK:SLOT[1]|2|3|4:POWer MAIN|DELTA  
[SOURCE]:RADio:PHS:ULINK:SLOT[1]|2|3|4:POWer?
```

This command toggles the selected timeslot RF output power as main or alternate (delta). This feature is only available with the Alternate Power Control Option UNA.

*RST value: Main

TETRA

```
[ :SOURce]:RADio:TETRa:SLOT[1]|2|3|4:POWer MAIN|DELTA  
[ :SOURce]:RADio:TETRa:SLOT[1]|2|3|4:POWer?
```

This command toggles the selected timeslot RF output power as main or alternate (delta). This feature is only available with the Alternate Power Control Option UNA.

*RST value: Main

Timeslot State

DECT - Portable Part Timeslots

```
[ :SOURce]:RADio:DECT:PPart:SLOT0|[1]|2|3|4|5|6|7|8|9|10|11:STATe  
ON|OFF|1|0  
[ :SOURce]:RADio:DECT:PPart:SLOT0|[1]|2|3|4|5|6|7|8|9|10|11:STATe?
```

This command sets the operating state of the selected portable part timeslot. The choices are timeslots 0 through 11 On (1) or Off (0).

*RST value: timeslot 0 On, timeslots 1 through 11 Off

DECT - Radio Fixed Part Timeslots

```
[ :SOURce]:RADio:DECT:RFPart:SLOT0|[1]|2|3|4|5|6|7|8|9|10|11:STATe  
ON|OFF|1|0  
[ :SOURce]:RADio:DECT:RFPart:SLOT0|[1]|2|3|4|5|6|7|8|9|10|11:STATe?
```

This command sets the operating state of the selected timeslot. The choices are timeslots 0 through 11 On (1) or Off (0).

*RST value: timeslot 0 On, timeslots 1 through 11 Off

EDGE

```
[ :SOURce]:RADio:EDGE:SLOT0|[1]|2|3|4|5|6|7:STATe ON|OFF|1|0  
[ :SOURce]:RADio:EDGE:SLOT0|[1]|2|3|4|5|6|7:STATe?
```

This command sets the operating state of the selected timeslot. The choices are timeslots 0 through 7 and ON (1) or OFF (0).

*RST value: timeslot 0 On, timeslots 1 through 7 Off

GSM

```
[ :SOURce]:RADio:GSM:SLOT0|[1]|2|3|4|5|6|7:STATe ON|OFF|1|0  
[ :SOURce]:RADio:GSM:SLOT0|[1]|2|3|4|5|6|7:STATe?
```

This command sets the operating state of the selected timeslot. The choices are timeslots 0 through 7 and ON (1) or OFF (0).

*RST value: timeslot 0 On, timeslots 1 through 7 Off

NADC

```
[SOURce]:RADio[:NADC]:SLOT[1]|2|3|4|5|6:STATe ON|OFF|1|0  
[SOURce]:RADio[:NADC]:SLOT[1]|2|3|4|5|6:STATe?
```

This command sets the operating state of the selected timeslot. The choices are timeslots 1 through 6 and On (1) or Off (0).

*RST value: timeslots 1 and 4 On, timeslots 2, 3, 5, and 6 Off

PDC

```
[ :SOURce]:RADio:PDC:SLOT0|[1]|2|3|4|5:STATe ON|OFF|1|0  
[ :SOURce]:RADio:PDC:SLOT0|[1]|2|3|4|5:STATe?
```

This command sets the operating state of the selected timeslot. The choices are timeslots 0 through 5 and On (1) or Off (0).

*RST value: timeslot 0 On, 1 through 5 Off

PHS - Downlink Timeslots

```
[SOURce]:RADio:PHS:DLINK:SLOT[1]|2|3|4:STATe ON|OFF|1|0  
[SOURce]:RADio:PHS:DLINK:SLOT[1]|2|3|4:STATe?
```

This command sets the operating state of the selected downlink timeslot. The choices are timeslots 1 through 4 and On (1) or Off (0).

*RST value: timeslot 1 On, 2 through 4 Off

PHS - Uplink Timeslots

```
[SOURce]:RADio:PHS:ULINK:SLOT[1]|2|3|4:STATe ON|OFF|1|0  
[SOURce]:RADio:PHS:ULINK:SLOT[1]|2|3|4:STATe?
```

This command sets the operating state of the selected uplink timeslot. The choices are timeslots 1 through 4 and On (1) or Off (0).

*RST value: timeslot 1 On, 2 through 4 Off

TETRA

```
[ :SOURce]:RADio:TETRa:SLOT[1]|2|3|4:STATe ON|OFF|1|0  
[ :SOURce]:RADio:TETRa:SLOT[1]|2|3|4:STATe?
```

This command sets the operating state of the selected timeslot. The choices are timeslots 1 through 4 On (1) or Off (0). Continuous timeslots cannot be disabled.

*RST value: timeslot 1 On, 2 through 4 Off

Timeslot Type

DECT - Portable Part Timeslots

```
[ :SOURCE ] : RADio : DECT : PPart : SLOt0 | [ 1 ] | 2 | 3 | 4 | 5 | 6 | 7 | 8 | 9 | 10 |  
11 [ :TYPE ] CUSToM | TRAFfic | LCApacity | ZTRaffic | ZLCapacity  
[ :SOURCE ] : RADio : DECT : PPart : SLOt0 | [ 1 ] | 2 | 3 | 4 | 5 | 6 | 7 | 8 | 9 | 10 | 11 [ :TYPE ] ?
```

This command enables you to select the timeslot type for the selected timeslot (0-11) in the portable part link. The choices are Custom, Traffic Bearer, Low Capacity, Traffic Bearer with Z Field, and Low Capacity with Z Field.

*RST value: timeslot 0 traffic bearer, timeslots 1-11 custom

DECT - Radio Fixed Part Timeslots

```
[ :SOURCE ] : RADio : DECT : RFPart : SLOt0 | [ 1 ] | 2 | 3 | 4 | 5 | 6 | 7 | 8 | 9 | 10 |  
11 [ :TYPE ] CUSToM | DUMM[ 1 ] | DUMM2 | TRAFfic | LCApacity | ZTRaffic | ZLCapacity  
[ :SOURCE ] : RADio : DECT : RFPart : SLOt0 | [ 1 ] | 2 | 3 | 4 | 5 | 6 | 7 | 8 | 9 | 10 | 11 [ :TYPE ] ?
```

This command enables you to select the timeslot type for the selected timeslot (0-11) in the radio fixed part link. The choices are timeslots 0 through 11 and Custom, Short Packet 1 (Dummy 1 with P00 in the first half), Short Packet 2 (Dummy 2 with P00 in the second half), Traffic Bearer (basic packet P32 for bi-directional communication), Low Capacity (low capacity packet P08j for bi-directional communication), Traffic Bearer with Z Field, and Low Capacity with Z Field.

*RST value: timeslot 0 traffic bearer, timeslots 1-11 custom

EDGE

```
[ :SOURCE ] : RADio : EDGE : SLOt0 | [ 1 ] | 2 | 3 | 4 | 5 | 6 | 7 [ :TYPE ] CUSToM | NORMaL | NORMAL_ALL  
[ :SOURCE ] : RADio : EDGE : SLOt0 | [ 1 ] | 2 | 3 | 4 | 5 | 6 | 7 [ :TYPE ] ?
```

This command enables you to set the timeslot type for the selected timeslot. The choices are timeslots 0 through 7 and Custom, Normal, or All Normal (all timeslots set to normal).

*RST value: all timeslots normal

GSM

```
[ :SOURCE ] : RADio : GSM : SLOt0 | [ 1 ] | 2 | 3 | 4 | 5 | 6 | 7 [ :TYPE ] CUSToM | NORMaL |  
FCORrection | SYNC | DUMMY | ACCess | NORMAL_ALL  
[ :SOURCE ] : RADio : GSM : SLOt0 | [ 1 ] | 2 | 3 | 4 | 5 | 6 | 7 [ :TYPE ] ?
```

This command enables you to set the timeslot type for the selected timeslot. The choices are timeslots 0 through 7 and Custom, Normal, Frequency Correction, Sync, Dummy, Access, or All Normal (all timeslots set to normal).

*RST value: timeslot 0 normal, timeslots 1-7 custom

NADC

```
[SOURCE]:RADIO[:NADC]:SLOT[1]|2|3|4|5|6[:TYPE] DCUSTOM|UCUSTOM|UTCH|  
UTCH_ALL|DTCH|DTCH_ALL  
[SOURCE]:RADIO[:NADC]:SLOT[1]|2|3|4|5|6[:TYPE]?
```

This command enables you to set the timeslot type for the selected timeslot. The choices are DCustom (Downlink Custom), UCustom (Uplink Custom), UTCH (Up Traffic Channel), UTCH All, DTCH (Down Traffic Channel), or DTCH All.

*RST value: timeslot 1 UTCH

PDC

```
[ :SOURCE]:RADIO:PDC:SLOT0|[1]|2|3|4|5|6[:TYPE] UCUSTOM|DCUSTOM|UTCH|  
UTCH_ALL|UVOX|DTCH|DTCH_ALL  
[ :SOURCE]:RADIO:PDC:SLOT0|[1]|2|3|4|5|6[:TYPE]?
```

This command enables you to set the timeslot type for the selected timeslot. The choices are UCustom (Uplink Custom), DCustom (Downlink Custom), UTCH (Up Traffic Channel), UTCH All, Up VOX, DTCH (Down Traffic Channel), or DTCH All.

*RST value: timeslot 1 UTCH

PHS - Downlink Timeslot Type

```
[SOURCE]:RADIO:PHS:DLINK:SLOT[1]|2|3|4[:TYPE] CUSTOM|TCH|TCH_ALL|SYNC  
[SOURCE]:RADIO:PHS:DLINK:SLOT[1]|2|3|4[:TYPE]?
```

This command enables you to set the downlink timeslot type for the selected timeslot. The choices are Traffic Channel (TCH), Synchronization burst (SYNC), Custom, or All Traffic Channels.

*RST value: timeslot 1 UTCH

PHS - Uplink Timeslot Type

```
[SOURCE]:RADIO:PHS:ULINK:SLOT[1]|2|3|4[:TYPE] CUSTOM|TCH|TCH_ALL|SYNC  
[SOURCE]:RADIO:PHS:ULINK:SLOT[1]|2|3|4[:TYPE]?
```

This command enables you to set the uplink timeslot type for the selected timeslot. The choices are Traffic Channel (TCH), Synchronization burst (SYNC), Custom, or All Traffic Channels.

*RST value: timeslot 1 UTCH

TETRA

```
[ :SOURCE ] :RADIo:TETRA:SLOT[ 1 ] | 2 | 3 | 4 [ :TYPE ] UCUSTom | UC1 | UC2 | UNORmal |  
DDNormal | DDSync | DCNormal | DCSync | DDCustom | DCCustom  
[ :SOURCE ] :RADIo:TETRA:SLOT[ 1 ] | 2 | 3 | 4 [ :TYPE ] ?
```

This command enables you to set the timeslot type for the selected timeslot. The choices are timeslots 1 through 4 and Uplink Custom, Uplink Control 1, Uplink Control 2, Uplink Normal, Downlink Discontinuous Normal, Downlink Discontinuous Synchronization, Downlink Continuous Normal, Downlink Continuous Synchronization, Downlink Discontinuous Custom, and Downlink Continuous Custom.

When Downlink is selected and the frame was Uplink, the following mapping is made to convert the Uplink protocols to Downlink. Also, an error will be generated.

From	To (Continuous Downlink Selected)	To (Discontinuous Downlink Selected)
UCUSTom	DCCustom	DDCustom
UC1	DCCustom	DDCustom
UC2	DCCustom	DDCustom
UNORmal	DCNormal	DDNormal

When Uplink is selected and the frame was Downlink, the following mapping is made to convert the Downlink protocols to Uplink. Also, an error will be generated.

From	To
DCCustom/ DDCustom	UCUSTom
DCNormal/ DDNormal	UNORmal
DCSync/ DDSync	UCUSTom

When continuous downlink protocols are selected, all timeslots must be on, and they cannot be turned off. Any attempts to do so will generate an error.

*RST value: uplink normal for all timeslots

Trailing Broadcast Bit (B2) Field

TETRA - Downlink Continuous Normal Timeslot

```
[ :SOURce]:RADio:TETRa:SLOT[1]|2|3|4:DCNormal:B2 <16-bit value>  
[ :SOURce]:RADio:TETRa:SLOT[1]|2|3|4:DCNormal:B2?
```

This command sets the last 16 broadcast bits for the selected downlink continuous normal timeslot.

Range: 0000 to 1FFF

*RST value: 0000 (hexadecimal)

TETRA - Downlink Discontinuous Normal Timeslot

```
[ :SOURce]:RADio:TETRa:SLOT[1]|2|3|4:DDNormal:B2 <16-bit value>  
[ :SOURce]:RADio:TETRa:SLOT[1]|2|3|4:DDNormal:B2?
```

This command sets the last 16 broadcast bits for the selected downlink continuous normal timeslot.

Range: 0000 to 1FFF

*RST value: 0000 (hexadecimal)

Training Sequence Field

EDGE/GSM - Normal Timeslot

```
[ :SOURce]:RADio:EDGE:SLOT0|[1]|2|3|4|5|6|7:NORMal:TSEquence TSC0|TSC1|  
TSC2|TSC3|TSC4|TSC5|TSC6|TSC7|<78 bit_pattern>  
[ :SOURce]:RADio:EDGE:SLOT0|[1]|2|3|4|5|6|7:NORMal:TSEquence?  
  
[ :SOURce]:RADio:GSM:SLOT0|[1]|2|3|4|5|6|7:NORMal:TSEquence  
TSC0|TSC1|TSC2|TSC3|TSC4|TSC5|TSC6|TSC7|<bit_pattern>  
[ :SOURce]:RADio:GSM:SLOT0|[1]|2|3|4|5|6|7:NORMal:TSEquence?
```

For EDGE, this command enables you to set the 78-bit training sequence code for a normal timeslot to one of eight values or to create a custom value. The default hexadecimal values for the eight training sequence codes are listed below:

TSC0	3F3F9E49FFF3FF3F9E49
TSC1	3F3C9E49E493FF3C9E49
TSC2	39FFF24F24F3F9FFF24F
TSC3	39FF924F279FF9FF924F
TSC4	3FE4F3C93F9FFFE4F3C9
TSC5	39FC93CF27FFF9FC93CF
TSC6	0F3F9249E4FFCF3F9249
TSC7	093C927FE7F3C93C927F

The default training sequence code reflects the EDGE protocol. Use hexadecimal for the 78-bit value in the SCPI command (precede the value with #H); the signal generator will convert it to binary.

For GSM, this command enables you to change the 26-bit training sequence (TS) for a normal timeslot. The preset hexadecimal value (when normal preset is selected) for TS reflects the GSM protocol, however you can enter a new value by using this command. The hexadecimal values for the 8 training sequence codes are listed below:

TSC0	0970897
TSC1	0B778B7
TSC2	10EE90E
TSC3	11ED11E
TSC4	06B906B
TSC5	13AC13A
TSC6	29F629F
TSC7	3BC4BBC

*RST value:

- EDGE: TSC0
- GSM: 0970897

Range:

- EDGE: 0 to 3FFFFFFFFFFFFFFFFFFFFF
- GSM: 0 to 3FFFFFFF

GSM - Dummy Timeslot

```
[SOURCE]:RADIO:GSM:SLOT0|[1]|2|3|4|5|6|7:DUMMY:TSEQUENCE TSC0|TSC1|TSC2|
TSC3|TSC4|TSC5|TSC6|TSC7|<bit_pattern>
[:SOURCE]:RADIO:GSM:SLOT0|[1]|2|3|4|5|6|7:DUMMY:TSEQUENCE?
```

This command enables you to change the 26-bit dummy training sequence (TS) for the selected dummy timeslot. The preset hexadecimal value (when normal preset is selected) for TS reflects the GSM protocol, however you can enter a new value by using this command.

The following table list the hexadecimal equivalents for training sequences 0 through 7.

Training Sequence	Hexadecimal Value
TSCO	0970897
TSC1	0B778B7
TSC2	10EE90E
TSC3	11ED11E
TSC4	06B906B
TSC5	13AC13A
TSC6	29F629F
TSC7	3BC4BBC

*RST value: 0970897

GSM - Synchronization Timeslot

```
[SOURCE]:RADio:GSM:SLOT0|[1]|2|3|4|5|6|7:SYNc:TSEquence <bit_ pattern>
[:SOURCE]:RADio:GSM:SLOT0|[1]|2|3|4|5|6|7:SYNc:TSEquence?
```

This command enables you to customize the training sequence (TS) for the selected synchronization timeslot. The preset hexadecimal value (when normal preset is selected) for TS reflects the GSM protocol, however you can enter a new value by using this command.

The following table list the hexadecimal equivalents for training sequences 0 through 7.

Training Sequence	Hexadecimal Value
TSCO	0970897
TSC1	0B778B7
TSC2	10EE90E
TSC3	11ED11E
TSC4	06B906B
TSC5	13AC13A
TSC6	29F629F
TSC7	3BC4BBC

*RST value: 0970897

TETRA - Downlink Continuous Normal Timeslot

```
[ :SOURce]:RADio:TETRa:SLOT[1] | 2 | 3 | 4:DCNormal:TSEquence <30-bit value>  
[ :SOURce]:RADio:TETRa:SLOT[1] | 2 | 3 | 4:DCNormal:TSEquence?
```

This command specifies the normal training sequence bits (30-bit midamble) for the selected downlink continuous normal timeslot. When 1E90DE is selected, the data fields are scrambled as separate logical channels.

Range: 000000 to 3FFFFFF

*RST value: 343A74

TETRA - Downlink Discontinuous Normal Timeslot

```
[ :SOURce]:RADio:TETRa:SLOT[1] | 2 | 3 | 4:DDNormal:TSEquence <30-bit value>  
[ :SOURce]:RADio:TETRa:SLOT[1] | 2 | 3 | 4:DDNormal:TSEquence?
```

This command specifies the normal training sequence bits (30-bit midamble) for the selected downlink discontinuous normal timeslot. When 1E90DE is selected, the data fields are scrambled as separate logical channels.

Range: 00000000 to 0FFFFFFF

*RST value: 343A74

TETRA - Uplink Control 1 Timeslot

```
[ :SOURce]:RADio:TETRa:SLOT[1] | 2 | 3 | 4:UC1:TSEquence <30-bit value>  
[ :SOURce]:RADio:TETRa:SLOT[1] | 2 | 3 | 4:UC1:TSEquence?
```

This command specifies the extended training sequence bits (30-bit midamble) for the selected uplink control 1 timeslot.

Range: 00000000 to 0FFFFFFF

*RST value: 2743A743

TETRA - Uplink Control 2 Timeslot

```
[ :SOURce]:RADio:TETRa:SLOT[1] | 2 | 3 | 4:UC2:TSEquence <30-bit value>  
[ :SOURce]:RADio:TETRa:SLOT[1] | 2 | 3 | 4:UC2:TSEquence?
```

This command specifies the extended training sequence bits (30-bit midamble) for the selected uplink control 2 timeslot.

Range: 000000 to 3FFFFFF

*RST value: 2743A743

TETRA - Uplink Normal Timeslot

```
[ :SOURCE ] : RADio : TETRa : SLOT [ 1 ] | 2 | 3 | 4 : UNORmal : TSEquence <22-bit value>  
[ :SOURCE ] : RADio : TETRa : SLOT [ 1 ] | 2 | 3 | 4 : UNORmal : TSEquence ?
```

This command specifies the extended training sequence bits (22-bit midamble) for the selected uplink normal timeslot. When 1E90DE is selected, the data fields are scrambled as separate logical channels.

Range: 000000 to 3FFFFFF

*RST value: 343A74

Trigger Source

```
[ :SOURCE ] : RADio : CUSTom : TRIGger [ :SOURCE ] KEY | EXT | BUS  
[ :SOURCE ] : RADio : CUSTom : TRIGger [ :SOURCE ] ?
```

```
[ :SOURCE ] : RADio : <desired format> : TRIGger [ :SOURCE ] KEY | EXT | BUS  
[ :SOURCE ] : RADio : <desired format> : TRIGger [ :SOURCE ] ?
```

This command sets the mode for triggering your unframed data pattern. The choices are Key (trigger using the front panel **Trigger** key), Ext (trigger using an external trigger supplied to the TRIGGER IN connector), or Bus (trigger with a command sent over GPIB). Pattern Trigger is *not* available with either a PN data sequence, or an external data source.

*RST value: Key

Unique Word Field

PHS - Downlink Synchronization Channel Timeslot

```
[ SOURCE ] : RADio : PHS : DLINK : SLOT [ 1 ] | 2 | 3 | 4 : SCHannel : UWORD <bit pattern>  
[ SOURCE ] : RADio : PHS : DLINK : SLOT [ 1 ] | 2 | 3 | 4 : SCHannel : UWORD ?
```

This command enables you to change the unique word (UW) field. The preset hexadecimal value (when normal preset is selected) for UW reflects the PHS protocol, however you can enter a new value entering this command. The UW value becomes the active function. The current value for UW is displayed in the UW field near the bottom of the text area of the display.

Range: 000000000 to 0FFFFFFF

*RST value: 050EF2993

PHS - Downlink Traffic Channel Timeslot

```
[SOURCE]:RADIO:PHS:DLINK:SLOT[1]|2|3|4:TChannel:UWORD <bit pattern>  
[SOURCE]:RADIO:PHS:DLINK:SLOT[1]|2|3|4:TChannel:UWORD?
```

This command enables you to change the unique word (UW) field. The preset hexadecimal value (when normal preset is selected) for UW reflects the PHS protocol, however you can enter a new value entering this command. The UW value becomes the active function. The current value for UW is displayed in the UW field near the bottom of the text area of the display.

Range: 000000000 to 0FFFFFFFF

*RST value: 050EF2993

PHS - Uplink Synchronization Channel Timeslot

```
[SOURCE]:RADIO:PHS:ULINK:SLOT[1]|2|3|4:SChannel:UWORD <bit pattern>  
[SOURCE]:RADIO:PHS:ULINK:SLOT[1]|2|3|4:SChannel:UWORD?
```

This command enables you to change the unique word (UW) field. The preset hexadecimal value (when normal preset is selected) for UW reflects the PHS protocol, however you can enter a new value entering this command. The UW value becomes the active function. The current value for UW is displayed in the UW field near the bottom of the text area of the display.

Range: 000000000 to 0FFFFFFFF

*RST value: 050EF2993

PHS - Uplink Traffic Channel Timeslot

```
[SOURCE]:RADIO:PHS:ULINK:SLOT[1]|2|3|4:TChannel:UWORD <bit pattern>  
[SOURCE]:RADIO:PHS:ULINK:SLOT[1]|2|3|4:TChannel:UWORD?
```

This command enables you to change the unique word (UW) field. The preset hexadecimal value (when normal preset is selected) for UW reflects the PHS protocol, however you can enter a new value entering this command. The UW value becomes the active function. The current value for UW is displayed in the UW field near the bottom of the text area of the display.

Range: 000000000 to 0FFFFFFFF

*RST value: 050EF2993

User FSK Files

See “Modulation Configuration - Type, User FSK, User IQ”

User I/Q Files

See “Modulation Configuration - Type, User FSK, User IQ”

Programming Examples

This section provides the following programming examples:

- “Generating a $\pi/4$ DQPSK Modulation Sensitivity Bit Error Test” on page 4-89
This example is presented in the following formats:
 - NADC on page 4-90
 - PHS on page 4-92
 - TETRA on page 4-94
- “Generating a DECT GFSK Modulation Sensitivity Bit Error Test” on page 4-96
- “Generating a GSM GMSK Modulation Sensitivity Bit Error Test” on page 4-98
- “Generating a PDC Sensitivity Bit Error Test” on page 4-100

Generating a $\pi/4$ DQPSK Modulation Sensitivity Bit Error Test

In this example, you configure the signal generator to the initial settings of a $\pi/4$ DQPSK modulation sensitivity bit error test. The initial settings are format default values, which you can change once the setup is complete.

This example is presented in the following formats:

- [NADC](#) on page 4-90
- [PHS](#) on page 4-92
- [TETRA](#) on page 4-94

NADC

Use this example to configure the signal generator to the initial settings of an NADC $\pi/4$ DQPSK modulation sensitivity bit error test. The carrier frequency is 825.250 MHz at 40 dBuV (displayed in dBm). You can change the NADC format default values once the setup is complete.

CLEAR and RESET the controller, type the following commands and RUN the program.

```

10 !*****
20 !
30 ! PROGRAM NAME:    NADC Rev.  2A796
40 !
50 ! PROGRAM DESCRIPTION:  In this example, the instrument is
60 ! configured to the initial settings of an NADC Pi/4 DQPSK
70 ! modulation sensitivity bit error test.  The carrier is a
80 ! frequency of .825250 GHz at 40 dBuV (displayed in dBm).  The
90 ! NADC format is initially set with default values which can
100 ! be changed once the setup is complete.
110 !
120 !
130 !
140 !
150 !*****

160 !
170 Sig_gen=719
180 LOCAL Sig_gen
190 CLEAR Sig_gen
200 CLEAR SCREEN
210 OUTPUT Sig_gen;"*RST"
220 OUTPUT Sig_gen;"*CLS"
230 ! *****
240 OUTPUT Sig_gen;"FREQ .825250 GHz"
250 OUTPUT Sig_gen;"POW 40 dBuV"
260 OUTPUT Sig_gen;"RAD:NADC:BURS:STAT ON"
270 OUTPUT Sig_gen;"RAD:NADC:SLOT1:TYPE UCUS"
280 OUTPUT Sig_gen;"RAD:NADC:SLOT1:STAT ON"
290 ! *****
300 OUTPUT Sig_gen;"RAD:NADC:STAT ON"
310 ! *****
320 OUTPUT Sig_gen;"OUTP ON"
330 ! *****
340 LOCAL Sig_gen
350 PRINT
360 PRINT "Wait until the `Baseband Data Generation' is complete, then ..."
370 PRINT
380 WAIT 5
390 PRINT "... Press the `Amplitude' key  to enable the UP/DWN arrows"
400 PRINT "and RPG knob  in order to adjust the output power level."
410 PRINT
420 WAIT 5
430 PRINT "Press RUN to start again."
440 END
  
```

Program Comments

10 to 160:	Title and program description
170:	Assign the signal generator's GPIB address to a variable.
180 to 200:	Sets the signal generator in LOCAL mode, and clears the controller's display.
210:	Set the signal generator to a defined state for programming.
220:	Clear the signal generator's Status Byte Register.
230:	Program border
240:	Set the signal generator's output carrier frequency to 825.250 MHz.
250:	Set the signal generator's output carrier power to 40 dBuV.
260:	Turn on frame burst.
270:	Configure the downlink timeslot 1 as an uplink custom channel type.
280:	Turn on timeslot 1.
290:	Program border
300:	Enables NADC modulation.
310:	Program border
320:	Turn on the RF output power.
330:	Program border
340:	Return the signal generator to LOCAL mode.
350 to 370:	Print a message to the controller's display.
380:	Wait 5 seconds.
390 to 410:	Print a message to the controller's display.
420:	Wait 5 seconds.
430:	Print a message to the controller's display.
440:	End the program.

PHS

Use this example to configure the signal generator to the initial settings of an PHS $\pi/4$ DQPSK modulation sensitivity bit error test. The carrier frequency is 1.89515 GHz at 40 dBuV (displayed in dBm). You can change the PHS format default values once the setup is complete.

CLEAR and RESET the controller, type the following commands and RUN the program.

```

10      !*****
20      !
30      ! PROGRAM NAME:      PHS                      Rev.   2A796
40      !
50      ! PROGRAM DESCRIPTION:  In this example, the instrument is configured to
60      ! the initial settings of a PHS Pi/4 DQPSK modulation sensitivity
70      ! Bit error test.  The carrier is a frequency of 1.89515 GHz
80      ! at 40 dBuV (displayed in dBm).  The PHS format is
90      ! initially set with default values which can be changed
100     ! once the setup is complete.
110     !
120     !
130     !
140     !
150     !*****
160     !
170     Sig_gen=719
180     LOCAL Sig_gen
190     CLEAR Sig_gen
200     CLEAR SCREEN
210     OUTPUT Sig_gen;"*RST"
220     OUTPUT Sig_gen;"*CLS"
230     ! *****
240     OUTPUT Sig_gen;"FREQ 1.89515 GHz"
250     OUTPUT Sig_gen;"POW 40 dBuV"
260     OUTPUT Sig_gen;"RAD:PHS:BURS:STAT ON"
270     OUTPUT Sig_gen;"RAD:PHS:DLIN:SLOT1:TYPE TCH"
280     OUTPUT Sig_gen;"RAD:PHS:DLIN:SLOT1:STAT ON"
290     ! *****
300     OUTPUT Sig_gen;"RAD:PHS:STAT ON"
310     ! *****
320     OUTPUT Sig_gen;"OUTP ON"
330     ! *****
340     LOCAL Sig_gen
350     PRINT
360     PRINT "Wait until the `Baseband Data Generation' is complete, then ..."
370     PRINT
380     WAIT 5
390     PRINT "... Press the `Amplitude' key  to enable the UP/DWN arrows"
400     PRINT "and RPG knob  in order to adjust the output power level."
410     PRINT
420     WAIT 5
430     PRINT "Press RUN to start again."
440     END
  
```

Program Comments

10 to 160:	Title and program description
170:	Assigns the signal generator's GPIB address to a variable.
180 to 200:	Sets the signal generator in LOCAL mode, and clears the controller's display.
210:	Sets the signal generator to a defined state for programming.
220:	Clears the signal generator's Status Byte Register.
230:	Program border
240:	Sets the signal generator's output carrier frequency to 1.89515 GHz.
250:	Sets the signal generator's output carrier power to 40 dBuV.
260:	Turns on frame burst.
270:	Configures the downlink timeslot 1 as a traffic channel type.
280:	Turns on timeslot 1.
290:	Program border
300:	Enables PHS modulation.
310:	Program border
320:	Turns on the RF output power.
330:	Program border
340:	Returns the signal generator to LOCAL mode.
350 to 370:	Prints a message to the controller's display.
380:	Waits 5 seconds.
390 to 410:	Prints a message to the controller's display.
420:	Waits 5 seconds.
430:	Prints a message to the controller's display.
440:	Ends the program.

TETRA

Use this example to configure the signal generator to the initial settings of an TETRA $\pi/4$ DQPSK modulation sensitivity bit error test. The carrier frequency is 0.400 GHz at 40 dBuV (displayed in dBm). You can change the TETRA format default values once the setup is complete.

CLEAR and RESET the controller, type the following commands and RUN the program.

```

10 !*****
20 !
30 ! PROGRAM NAME:   TETRA Rev.   2A796
40 !
50 ! PROGRAM DESCRIPTION:  In this example, the instrument is
60 ! configured to the initial settings of a TETRA Pi/4 DQPSK
70 ! modulation sensitivity bit error test.  The carrier is a
80 ! frequency of 0.400 GHz at 40 dBuV (displayed in dBm).The
90 ! TETRA format is initially set with default values which can
100 ! be changed once the setup is complete.
110 !
120 !
130 !
140 !
150 !*****

160 !
170 Sig_gen=719
180 LOCAL Sig_gen
190 CLEAR Sig_gen
200 CLEAR SCREEN
210 OUTPUT Sig_gen;"*RST"
220 OUTPUT Sig_gen;"*CLS"
230 ! *****
240 OUTPUT Sig_gen;"FREQ 0.400 GHz"
250 OUTPUT Sig_gen;"POW 40 dBuV"
260 OUTPUT Sig_gen;"RAD:TETRA:BURS:STAT ON"
270 OUTPUT Sig_gen;"RAD:TETRA:SLOT1:TYPE UNOR"
280 OUTPUT Sig_gen;"RAD:TETRA:SLOT1:STAT ON"
290 ! *****
300 OUTPUT Sig_gen;"RAD:TETRA:STAT ON"
310 ! *****
320 OUTPUT Sig_gen;"OUTP ON"
330 ! *****
340 LOCAL Sig_gen
350 PRINT
360 PRINT "Wait until the `Baseband Data Generation' is complete, then ..."
370 PRINT
380 WAIT 5
390 PRINT "... Press the `Amplitude' key  to enable the UP/DWN arrows"
400 PRINT "and RPG knob  in order to adjust the output power level."
410 PRINT
420 WAIT 5
430 PRINT "Press RUN to start again."
440 END

```

Program Comments

10 to 160:	Title and program description
170:	Assign the signal generator's GPIB address to a variable.
180 to 200:	Sets the signal generator in LOCAL mode, and clears the controller's display.
210:	Set the signal generator to a defined state for programming.
220:	Clear the signal generator's Status Byte Register.
230:	Program border
240:	Set the signal generator's output carrier frequency to 400 MHz.
250:	Set the signal generator's output carrier power to 40 dBuV.
260:	Turn on frame burst.
270:	Configure the downlink timeslot 1 as an uplink normal channel type.
280:	Turn on timeslot 1.
290:	Program border
300:	Enables TETRA modulation.
310:	Program border
320:	Turn on the RF output power.
330:	Program border
340:	Return the signal generator to LOCAL mode.
350 to 370:	Print a message to the controller's display.
380:	Wait 5 seconds.
390 to 410:	Print a message to the controller's display.
420:	Wait 5 seconds.
430:	Print a message to the controller's display.
440:	End the program.

Generating a DECT GFSK Modulation Sensitivity Bit Error Test

Use this example to configure the signal generator to the initial settings of an DECT GFSK modulation sensitivity bit error test. The carrier frequency is 1.89515 GHz at 40 dBuV (displayed in dBm). You can change the DECT format default values once the setup is complete.

CLEAR and RESET the controller, type the following commands and RUN the program.

```
10 !*****
20 !
30 ! PROGRAM NAME:   DECT Rev.  2A796
40 !
50 ! PROGRAM DESCRIPTION:  In this example, the instrument is
60 ! configured to the initial settings of a DECT GFSK
70 ! modulation sensitivity bit error test.  The carrier is a
80 ! frequency of 1.89515 GHz at 40 dBuV (displayed in dBm).  The
90 ! DECT format is initially set with default values which can
100 ! be changed once the setup is complete.
110 !
120 !
130 !
140 !
150 !*****

160 !
170 Sig_gen=719
180 LOCAL Sig_gen
190 CLEAR Sig_gen
200 CLEAR SCREEN
210 OUTPUT Sig_gen;"*RST"
220 OUTPUT Sig_gen;"*CLS"
230 ! *****
240 OUTPUT Sig_gen;"FREQ 1.89515 GHz"
250 OUTPUT Sig_gen;"POW 40 dBuV"
260 OUTPUT Sig_gen;"RAD:DECT:BURS:STAT ON"
270 OUTPUT Sig_gen;"RAD:DECT:RFP:SLOT0:TYPE TRAF"
280 OUTPUT Sig_gen;"RAD:DECT:RFP:SLOT0:STAT ON"
290 ! *****
300 OUTPUT Sig_gen;"RAD:DECT:BURS ON"
310 ! *****
320 OUTPUT Sig_gen;"OUTP ON"
330 ! *****
340 LOCAL Sig_gen
350 PRINT
360 PRINT "Wait until the `Baseband Data Generation' is complete, then ..."
370 PRINT
380 WAIT 5
390 PRINT "... Press the `Amplitude' key  to enable the UP/DWN arrows"
400 PRINT "and RPG knob  in order to adjust the output power level."
410 PRINT
420 WAIT 5
430 PRINT "Press RUN to start again."
440 END
```

Program Comments

10 to 160:	Title and program description
170:	Assign the signal generator's GPIB address to a variable.
180 to 200:	Sets the signal generator in LOCAL mode, and clears the controller's display.
210:	Set the signal generator to a defined state for programming.
220:	Clear the signal generator's Status Byte Register.
230:	Program border
240:	Set the signal generator's output carrier frequency to 1.89515 GHz.
250:	Set the signal generator's output carrier power to 40 dBuV.
260:	Turn on frame burst.
270:	Configure the downlink timeslot 0 as a radio fixed part traffic channel type.
280:	Turn on timeslot 1.
290:	Program border
300:	Enables DECT modulation.
310:	Program border
320:	Turn on the RF output power.
330:	Program border
340:	Return the signal generator to LOCAL mode.
350 to 370:	Print a message to the controller's display.
380:	Wait 5 seconds.
390 to 410:	Print a message to the controller's display.
420:	Wait 5 seconds.
430:	Print a message to the controller's display.
440:	End the program.

Generating a GSM GMSK Modulation Sensitivity Bit Error Test

Use this example to configure the signal generator to the initial settings of an GSM GMSK modulation sensitivity bit error test. The carrier frequency is 940 MHz at 40 dBuV (displayed in dBm). You can change the GSM format default values once the setup is complete.

CLEAR and RESET the controller, type the following commands and RUN the program.

```

10 !*****
20 !
30 ! PROGRAM NAME:   GSM Rev.   2A796
40 !
50 ! PROGRAM DESCRIPTION:  In this example, the instrument is
60 ! configured to the initial settings of a GSM GMSK
70 ! modulation sensitivity bit error test.  The carrier is a
80 ! frequency of 940 MHz at 40 dBuV (displayed in dBm).  The
90 ! GSM format is initially set with default values which can
100 ! be changed once the setup is complete.
110 !
120 !
130 !
140 !
150 !*****

160 !
170 Sig_gen=719
180 LOCAL Sig_gen
190 CLEAR Sig_gen
200 CLEAR SCREEN
210 OUTPUT Sig_gen;"*RST"
220 OUTPUT Sig_gen;"*CLS"
230 ! *****
240 OUTPUT Sig_gen;"FREQ .940 GHz"
250 OUTPUT Sig_gen;"POW 40 dBuV"
260 OUTPUT Sig_gen;"RAD:GSM:BURS:STAT ON"
270 OUTPUT Sig_gen;"RAD:GSM:SLOT0:TYPE NORM"
280 OUTPUT Sig_gen;"RAD:GSM:SLOT0:STAT ON"
290 ! *****
300 OUTPUT Sig_gen;"RAD:GSM:STAT ON"
310 ! *****
320 OUTPUT Sig_gen;"OUTP ON"
330 ! *****
340 LOCAL Sig_gen
350 PRINT
360 PRINT "Wait until the `Baseband Data Generation' is complete, then ..."
370 PRINT
380 WAIT 5
390 PRINT "... Press the `Amplitude' key to enable the UP/DWN arrows"
400 PRINT "and RPG knob in order to adjust the output power level."
410 PRINT
420 WAIT 5
430 PRINT "Press RUN to start again."
440 END
  
```

Program Comments

10 to 160:	Title and program description
170:	Assigns the signal generator's GPIB address to a variable.
180 to 200:	Sets the signal generator in LOCAL mode, and clears the controller's display.
210:	Sets the signal generator to a defined state for programming.
220:	Clears the signal generator's Status Byte Register.
230:	Program border
240:	Sets the signal generator's output carrier frequency to 940 MHz.
250:	Sets the signal generator's output carrier power to 40 dBuV.
260:	Turns on frame burst.
270:	Configures the downlink timeslot 0 as a normal channel type.
280:	Turns on timeslot 0.
290:	Program border
300:	Enables GSM modulation.
310:	Program border
320:	Turns on the RF output power.
330:	Program border
340:	Returns the signal generator to LOCAL mode.
350 to 370:	Prints a message to the controller's display.
380:	Waits 5 seconds.
390 to 410:	Prints a message to the controller's display.
420:	Waits 5 seconds.
430:	Prints a message to the controller's display.
440:	Ends the program.

Generating a PDC Sensitivity Bit Error Test

Use this example to configure the signal generator to the initial settings of PDC modulation sensitivity bit error test. The carrier frequency is 815 MHz at 40 dBuV (displayed in dBm). You can change the PDC format default values once the setup is complete.

CLEAR and RESET the controller, type the following commands and RUN the program.

```

10      !*****
20      !
30      ! NAME:      PDC                      Rev.   2A796
40      !
50      ! DESCRIPTION: In this example, the instrument is configured to the
60      ! initial settings of a PDC sensitivity Bit error test
70      ! with a carrier frequency of 815 MHz at 40 dBuV (displayed
80      ! in dBm). The PDC format is initially set with default
90      ! values which can be changed once the setup is complete.
100     !
110     !
120     !
130     !
140     !*****
150     !
160     Sig_gen=719
170     LOCAL Sig_gen
180     CLEAR Sig_gen
190     CLEAR SCREEN
200     OUTPUT Sig_gen;"*RST"
210     OUTPUT Sig_gen;"*CLS"
220     ! *****
230     OUTPUT Sig_gen;"FREQ 815 MHz"
240     OUTPUT Sig_gen;"POW 40 dBuV"
250     OUTPUT Sig_gen;"RAD:PDC:BURS:STAT ON"
260     OUTPUT Sig_gen;"RAD:PDC:FRAT FULL"
270     OUTPUT Sig_gen;"RAD:PDC:SLOT0 DTCH"
280     OUTPUT Sig_gen;"RAD:PDC:SLOT0:STAT ON"
290     ! *****
300     OUTPUT Sig_gen;"RAD:PDC:STAT ON"
310     ! *****
320     OUTPUT Sig_gen;"OUTP ON"
330     ! *****
340     LOCAL Sig_gen
350     PRINT
360     PRINT "Wait until the `Baseband Data Generation' is complete, then ..."
370     PRINT
380     WAIT 5
390     PRINT "... Press the `Amplitude' key to enable the UP/DWN arrows"
400     PRINT "and RPG knob in order to adjust the output power level."
410     PRINT
420     WAIT 5
430     PRINT "Press RUN to start again."
440     END
  
```

Program Comments

10 to 150:	Title and program description
160:	Assigns the signal generator's GPIB address to a variable.
170 to 190:	Sets the signal generator to LOCAL mode, and clear the controller's display.
200	Sets the signal generator to a defined state for programming.
210:	Clears the signal generator's Status Byte Register.
220:	Program border
230:	Sets the carrier frequency to 815 MHz.
240:	Sets the carrier power level to 40 dBuV.
250:	Turns on frame burst.
260:	Selects full rate which pairs timeslots 0, 1, and 2 with 3, 4, and 5.
270:	Configures timeslot 0 as a down traffic channel type.
280:	Turns on timeslot 0.
290:	Program border
300:	Enables PDC modulation.
310:	Program border
320:	Turns on the signal generator's RF output.
330:	Program border
340:	Returns the signal generator to LOCAL mode.
350 to 370:	Prints a message to the controller's display.
380:	Waits five seconds.
390 to 410:	Prints a message to the controller's display.
420:	Waits five seconds.
430:	Prints a message to the controller's display.
440:	Ends the program.

5 Softkey/Command Cross-Reference

This chapter lists Options UN8 and 202 softkeys and their corresponding SCPI commands. For a list of the signal generator's standard keys and their corresponding SCPI commands, refer to the programming guide.

In the following tables, when there is an entry for the custom format, it is given first. Where you see the variable <desired format> replace it with one of the following modulation formats:

- DECT
- EDGE
- GSM
- NADC
- PDC
- PHS
- TETRA

Key	SCPI Command
π/4DPSK	[:SOURCE]:RADIO:CUSTOM:MODULATION[:TYPE] P4DQPSK [:SOURCE]:RADIO:CUSTOM:MODULATION[:TYPE]?
	[:SOURCE]:RADIO:<desired format>:MODULATION[:TYPE] P4DQPSK [:SOURCE]:RADIO:<desired format>:MODULATION[:TYPE]?
2-Lvl FSK	[:SOURCE]:RADIO:CUSTOM:MODULATION[:TYPE] FSK2 [:SOURCE]:RADIO:CUSTOM:MODULATION[:TYPE]?
	[:SOURCE]:RADIO:<desired format>:MODULATION[:TYPE] FSK2 [:SOURCE]:RADIO:<desired format>:MODULATION[:TYPE]?
3-Bit Sync	[:SOURCE]:RADIO:EDGE:BNCMux:SSOut TBSync [:SOURCE]:RADIO:EDGE:BNCMux:SSOut?
4 1's & 4 0's	[:SOURCE]:RADIO:CUSTOM:DATA P4 [:SOURCE]:RADIO:CUSTOM:DATA? [:SOURCE]:RADIO:<desired format>:DATA P4 [:SOURCE]:RADIO:<desired format>:DATA?

Key	SCPI Command
<p>4 1's & 4 0's continued</p>	<pre>[:SOURce]:RADio:DECT:PPart:SLOT0 [1] 2 3 4 5 6 7 8 9 10 11:CUSTom P4 [:SOURce]:RADio:DECT:PPart:SLOT0 [1] 2 3 4 5 6 7 8 9 10 11:CUSTom? [:SOURce]:RADio:DECT:PPart:SLOT0 [1] 2 3 4 5 6 7 8 9 10 11:LCAPacity [:B] P4 [:SOURce]:RADio:DECT:PPart:SLOT0 [1] 2 3 4 5 6 7 8 9 10 11:LCAPacity[:B]? [:SOURce]:RADio:DECT:PPart:SLOT0 [1] 2 3 4 5 6 7 8 9 10 11:TRAFfic [:B] P4 [:SOURce]:RADio:DECT:PPart:SLOT0 [1] 2 3 4 5 6 7 8 9 10 11:TRAFfic[:B]? [:SOURce]:RADio:DECT:PPart:SLOT0 [1] 2 3 4 5 6 7 8 9 10 11:ZLCapacity [:B] P4 [:SOURce]:RADio:DECT:PPart:SLOT0 [1] 2 3 4 5 6 7 8 9 10 11:ZLCapacity[:B]? [:SOURce]:RADio:DECT:PPart:SLOT0 [1] 2 3 4 5 6 7 8 9 10 11:ZTRaffic [:B] P4 [:SOURce]:RADio:DECT:PPart:SLOT0 [1] 2 3 4 5 6 7 8 9 10 11:ZTRaffic[:B]? [:SOURce]:RADio:DECT:RFPart:SLOT0 [1] 2 3 4 5 6 7 8 9 10 11:CUSTom P4 [:SOURce]:RADio:DECT:RFPart:SLOT0 [1] 2 3 4 5 6 7 8 9 10 11:CUSTom? [:SOURce]:RADio:DECT:RFPart:SLOT0 [1] 2 3 4 5 6 7 8 9 10 11:LCAPacity [:B] P4 [:SOURce]:RADio:DECT:RFPart:SLOT0 [1] 2 3 4 5 6 7 8 9 10 11:LCAPacity[:B]? [:SOURce]:RADio:DECT:RFPart:SLOT0 [1] 2 3 4 5 6 7 8 9 10 11:TRAFfic [:B] P4 [:SOURce]:RADio:DECT:RFPart:SLOT0 [1] 2 3 4 5 6 7 8 9 10 11:TRAFfic[:B]? [:SOURce]:RADio:DECT:RFPart:SLOT0 [1] 2 3 4 5 6 7 8 9 10 11:ZLCapacity [:B] P4 [:SOURce]:RADio:DECT:RFPart:SLOT0 [1] 2 3 4 5 6 7 8 9 10 11:ZLCapacity[:B]? [:SOURce]:RADio:DECT:RFPart:SLOT0 [1] 2 3 4 5 6 7 8 9 10 11:ZTRaffic [:B] P4 [:SOURce]:RADio:DECT:RFPart:SLOT0 [1] 2 3 4 5 6 7 8 9 10 11:ZTRaffic[:B]?</pre>
	<pre>[:SOURce]:RADio:EDGE:SLOT0 [1] 2 3 4 5 6 7:CUSTom P4 [:SOURce]:RADio:EDGE:SLOT0 [1] 2 3 4 5 6 7:CUSTom? [:SOURce]:RADio:EDGE:SLOT0 [1] 2 3 4 5 6 7:NORMal:ENCRyption P4 [:SOURce]:RADio:EDGE:SLOT0 [1] 2 3 4 5 6 7:NORMal:ENCRyption?</pre>

Key	SCPI Command
4 1's & 4 0's continued	[:SOURCE]:RADio:GSM:SLOT0 [1] 2 3 4 5 6 7:ACCEss:ENCryption P4 [:SOURCE]:RADio:GSM:SLOT0 [1] 2 3 4 5 6 7:ACCEss:ENCryption?
	[:SOURCE]:RADio:GSM:SLOT0 [1] 2 3 4 5 6 7:CUSTom P4 [:SOURCE]:RADio:GSM:SLOT0 [1] 2 3 4 5 6 7:CUSTom?
	[:SOURCE]:RADio:GSM:SLOT0 [1] 2 3 4 5 6 7:NORMAl:ENCryption P4 [:SOURCE]:RADio:GSM:SLOT0 [1] 2 3 4 5 6 7:NORMAl:ENCryption?
	[:SOURCE]:RADio:GSM:SLOT0 [1] 2 3 4 5 6 7:SYNC:ENCryption P4 [:SOURCE]:RADio:GSM:SLOT0 [1] 2 3 4 5 6 7:SYNC:ENCryption?
	[:SOURCE]:RADio[:NADC]:SLOT[1] 2 3 4 5 6:DCUStom P4 [:SOURCE]:RADio[:NADC]:SLOT[1] 2 3 4 5 6:DCUStom?
	[:SOURCE]:RADio[:NADC]:SLOT[1] 2 3 4 5 6:DTCHannel[:DATA] P4 [:SOURCE]:RADio[:NADC]:SLOT[1] 2 3 4 5 6:DTCHannel[:DATA]?
	[:SOURCE]:RADio[:NADC]:SLOT[1] 2 3 4 5 6:UCUStom P4 [:SOURCE]:RADio[:NADC]:SLOT[1] 2 3 4 5 6:UCUStom?
	[:SOURCE]:RADio[:NADC]:SLOT[1] 2 3 4 5 6:UTCHannel[:DATA] P4 [:SOURCE]:RADio[:NADC]:SLOT[1] 2 3 4 5 6:UTCHannel[:DATA]?
	[:SOURCE]:RADio:PDC:SLOT0 [1] 2 3 4 5:DCUStom P4 [:SOURCE]:RADio:PDC:SLOT0 [1] 2 3 4 5:DCUStom?
	[:SOURCE]:RADio:PDC:SLOT0 [1] 2 3 4 5:DTCHannel[:TChannel] P4 [:SOURCE]:RADio:PDC:SLOT0 [1] 2 3 4 5:DTCHannel[:TChannel]?
	[:SOURCE]:RADio:PDC:SLOT0 [1] 2 3 4 5:UCUStom P4 [:SOURCE]:RADio:PDC:SLOT0 [1] 2 3 4 5:UCUStom?
	[:SOURCE]:RADio:PDC:SLOT0 [1] 2 3 4 5:UTCHannel[:TChannel] P4 [:SOURCE]:RADio:PDC:SLOT0 [1] 2 3 4 5:UTCHannel[:TChannel]?
	[:SOURCE]:RADio:PHS:DLINK:SLOT[1] 2 3 4:CUSTom P4 [:SOURCE]:RADio:PHS:DLINK:SLOT[1] 2 3 4:CUSTom?
	[:SOURCE]:RADio:PHS:DLINK:SLOT[1] 2 3 4:TCHannel[:TChannel] P4 [:SOURCE]:RADio:PHS:DLINK:SLOT[1] 2 3 4:TCHannel[:TChannel]?
	[:SOURCE]:RADio:PHS:ULINK:SLOT[1] 2 3 4:CUSTom P4 [:SOURCE]:RADio:PHS:ULINK:SLOT[1] 2 3 4:CUSTom?
	[:SOURCE]:RADio:PHS:ULINK:SLOT[1] 2 3 4:TCHannel[:TChannel] P4 [:SOURCE]:RADio:PHS:ULINK:SLOT[1] 2 3 4:TCHannel[:TChannel]?

Key	SCPI Command
<p>4 1's & 4 0's continued</p>	<pre>[:SOURCE]:RADio:TETRa:SLOT[1] 2 3 4:DCCustom P4 [:SOURCE]:RADio:TETRa:SLOT[1] 2 3 4:DCCustom? [:SOURCE]:RADio:TETRa:SLOT[1] 2 3 4:DCNormal[:DATA] P4 [:SOURCE]:RADio:TETRa:SLOT[1] 2 3 4:DCNormal[:DATA]? [:SOURCE]:RADio:TETRa:SLOT[1] 2 3 4:DCSync[:DATA] P4 [:SOURCE]:RADio:TETRa:SLOT[1] 2 3 4:DCSync[:DATA]? [:SOURCE]:RADio:TETRa:SLOT[1] 2 3 4:DDCustom[:DATA] P4 [:SOURCE]:RADio:TETRa:SLOT[1] 2 3 4:DDCustom[:DATA]? [:SOURCE]:RADio:TETRa:SLOT[1] 2 3 4:DDNormal[:DATA] P4 [:SOURCE]:RADio:TETRa:SLOT[1] 2 3 4:DDNormal[:DATA]? [:SOURCE]:RADio:TETRa:SLOT[1] 2 3 4:DDSync[:DATA] P4 [:SOURCE]:RADio:TETRa:SLOT[1] 2 3 4:DDSync[:DATA]? [:SOURCE]:RADio:TETRa:SLOT[1] 2 3 4:UC1[:DATA] P4 [:SOURCE]:RADio:TETRa:SLOT[1] 2 3 4:UC1[:DATA]? [:SOURCE]:RADio:TETRa:SLOT[1] 2 3 4:UC2[:DATA] P4 [:SOURCE]:RADio:TETRa:SLOT[1] 2 3 4:UC2[:DATA]? [:SOURCE]:RADio:TETRa:SLOT[1] 2 3 4:UCUStom P4 [:SOURCE]:RADio:TETRa:SLOT[1] 2 3 4:UCUStom? [:SOURCE]:RADio:TETRa:SLOT[1] 2 3 4:UNORmal[:DATA] P4 [:SOURCE]:RADio:TETRa:SLOT[1] 2 3 4:UNORmal[:DATA]?</pre>
<p>4-Lvl FSK</p>	<pre>[:SOURCE]:RADio:CUSTom:MODulation[:TYPE] FSK4 [:SOURCE]:RADio:CUSTom:MODulation[:TYPE]? [:SOURCE]:RADio:<desired format>:MODulation[:TYPE] FSK4 [:SOURCE]:RADio:<desired format>:MODulation[:TYPE]?</pre>
<p>4QAM</p>	<pre>[:SOURCE]:RADio:CUSTom:MODulation[:TYPE] QAM4 [:SOURCE]:RADio:CUSTom:MODulation[:TYPE]? [:SOURCE]:RADio:<desired format>:MODulation[:TYPE] QAM4 [:SOURCE]:RADio:<desired format>:MODulation[:TYPE]?</pre>
<p>8 1's & 8 0's</p>	<pre>[:SOURCE]:RADio:CUSTom:DATA P8 [:SOURCE]:RADio:CUSTom:DATA? [:SOURCE]:RADio:<desired format>:DATA P8 [:SOURCE]:RADio:<desired format>:DATA?</pre>

Key	SCPI Command
8 1's & 8 0's continued	[:SOURCE]:RADio:DECT:PPart:SLOT0 [1] 2 3 4 5 6 7 8 9 10 11:CUSTom P8 [:SOURCE]:RADio:DECT:PPart:SLOT0 [1] 2 3 4 5 6 7 8 9 10 11:CUSTom?
	[:SOURCE]:RADio:DECT:PPart:SLOT0 [1] 2 3 4 5 6 7 8 9 10 11:LCAPacity [:B] P8 [:SOURCE]:RADio:DECT:PPart:SLOT0 [1] 2 3 4 5 6 7 8 9 10 11:LCAPacity[:B]?
	[:SOURCE]:RADio:DECT:PPart:SLOT0 [1] 2 3 4 5 6 7 8 9 10 11:TRAFfic [:B] P8 [:SOURCE]:RADio:DECT:PPart:SLOT0 [1] 2 3 4 5 6 7 8 9 10 11:TRAFfic[:B]?
	[:SOURCE]:RADio:DECT:PPart:SLOT0 [1] 2 3 4 5 6 7 8 9 10 11:ZLCapacity [:B] P8 [:SOURCE]:RADio:DECT:PPart:SLOT0 [1] 2 3 4 5 6 7 8 9 10 11:ZLCapacity[:B]?
	[:SOURCE]:RADio:DECT:PPart:SLOT0 [1] 2 3 4 5 6 7 8 9 10 11:ZTRAffic [:B] P8 [:SOURCE]:RADio:DECT:PPart:SLOT0 [1] 2 3 4 5 6 7 8 9 10 11:ZTRAffic[:B]?
	[:SOURCE]:RADio:DECT:RFPart:SLOT0 [1] 2 3 4 5 6 7 8 9 10 11:CUSTom P8 [:SOURCE]:RADio:DECT:RFPart:SLOT0 [1] 2 3 4 5 6 7 8 9 10 11:CUSTom?
	[:SOURCE]:RADio:DECT:RFPart:SLOT0 [1] 2 3 4 5 6 7 8 9 10 11:LCAPacity [:B] P8 [:SOURCE]:RADio:DECT:RFPart:SLOT0 [1] 2 3 4 5 6 7 8 9 10 11:LCAPacity[:B]?
	[:SOURCE]:RADio:DECT:RFPart:SLOT0 [1] 2 3 4 5 6 7 8 9 10 11:TRAFfic [:B] P8 [:SOURCE]:RADio:DECT:RFPart:SLOT0 [1] 2 3 4 5 6 7 8 9 10 11:TRAFfic[:B]?
	[:SOURCE]:RADio:DECT:RFPart:SLOT0 [1] 2 3 4 5 6 7 8 9 10 11:ZLCapacity [:B] P8 [:SOURCE]:RADio:DECT:RFPart:SLOT0 [1] 2 3 4 5 6 7 8 9 10 11:ZLCapacity[:B]?
	[:SOURCE]:RADio:DECT:RFPart:SLOT0 [1] 2 3 4 5 6 7 8 9 10 11:ZTRAffic [:B] P8 [:SOURCE]:RADio:DECT:RFPart:SLOT0 [1] 2 3 4 5 6 7 8 9 10 11:ZTRAffic[:B]?
	[:SOURCE]:RADio:EDGE:SLOT0 [1] 2 3 4 5 6 7:CUSTom P8 [:SOURCE]:RADio:EDGE:SLOT0 [1] 2 3 4 5 6 7:CUSTom?
	[:SOURCE]:RADio:EDGE:SLOT0 [1] 2 3 4 5 6 7:NORMAl:ENCRyption P8 [:SOURCE]:RADio:EDGE:SLOT0 [1] 2 3 4 5 6 7:NORMAl:ENCRyption?

Key	SCPI Command
81's & 80's continued	<pre>[:SOURCE]:RADio:GSM:SLOT0 [1] 2 3 4 5 6 7:ACCess:ENCRyption P8 [:SOURCE]:RADio:GSM:SLOT0 [1] 2 3 4 5 6 7:ACCess:ENCRyption? [:SOURCE]:RADio:GSM:SLOT0 [1] 2 3 4 5 6 7:CUSTom P8 [:SOURCE]:RADio:GSM:SLOT0 [1] 2 3 4 5 6 7:CUSTom? [:SOURCE]:RADio:GSM:SLOT0 [1] 2 3 4 5 6 7:NORMal:ENCRyption P8 [:SOURCE]:RADio:GSM:SLOT0 [1] 2 3 4 5 6 7:NORMal:ENCRyption? [:SOURCE]:RADio:GSM:SLOT0 [1] 2 3 4 5 6 7:SYNC:ENCRyption P8 [:SOURCE]:RADio:GSM:SLOT0 [1] 2 3 4 5 6 7:SYNC:ENCRyption?</pre>
	<pre>[:SOURCE]:RADio[:NADC]:SLOT[1] 2 3 4 5 6:DCUStom P8 [:SOURCE]:RADio[:NADC]:SLOT[1] 2 3 4 5 6:DCUStom? [:SOURCE]:RADio[:NADC]:SLOT[1] 2 3 4 5 6:DTCHannel[:DATA] P8 [:SOURCE]:RADio[:NADC]:SLOT[1] 2 3 4 5 6:DTCHannel[:DATA]? [:SOURCE]:RADio[:NADC]:SLOT[1] 2 3 4 5 6:UCUStom P8 [:SOURCE]:RADio[:NADC]:SLOT[1] 2 3 4 5 6:UCUStom? [:SOURCE]:RADio[:NADC]:SLOT[1] 2 3 4 5 6:UTCHannel[:DATA] P8 [:SOURCE]:RADio[:NADC]:SLOT[1] 2 3 4 5 6:UTCHannel[:DATA]?</pre>
	<pre>[:SOURCE]:RADio:PDC:SLOT0 [1] 2 3 4 5:DCUStom P8 [:SOURCE]:RADio:PDC:SLOT0 [1] 2 3 4 5:DCUStom? [:SOURCE]:RADio:PDC:SLOT0 [1] 2 3 4 5:DTCHannel[:TCHannel] P8 [:SOURCE]:RADio:PDC:SLOT0 [1] 2 3 4 5:DTCHannel[:TCHannel]? [:SOURCE]:RADio:PDC:SLOT0 [1] 2 3 4 5:UCUStom P8 [:SOURCE]:RADio:PDC:SLOT0 [1] 2 3 4 5:UCUStom? [:SOURCE]:RADio:PDC:SLOT0 [1] 2 3 4 5:UTCHannel[:TCHannel] P8 [:SOURCE]:RADio:PDC:SLOT0 [1] 2 3 4 5:UTCHannel[:TCHannel]?</pre>
	<pre>[:SOURCE]:RADio:PHS:DLINK:SLOT[1] 2 3 4:CUSTom P8 [:SOURCE]:RADio:PHS:DLINK:SLOT[1] 2 3 4:CUSTom? [:SOURCE]:RADio:PHS:DLINK:SLOT[1] 2 3 4:TCHannel[:TCHannel] P8 [:SOURCE]:RADio:PHS:DLINK:SLOT[1] 2 3 4:TCHannel[:TCHannel]? [:SOURCE]:RADio:PHS:ULINK:SLOT[1] 2 3 4:CUSTom P8 [:SOURCE]:RADio:PHS:ULINK:SLOT[1] 2 3 4:CUSTom? [:SOURCE]:RADio:PHS:ULINK:SLOT[1] 2 3 4:TCHannel[:TCHannel] P8 [:SOURCE]:RADio:PHS:ULINK:SLOT[1] 2 3 4:TCHannel[:TCHannel]?</pre>

Key	SCPI Command
8 1's & 8 0's continued	<pre>[:SOURce]:RADio:TETRa:SLOT[1] 2 3 4:DCCustom P8 [:SOURce]:RADio:TETRa:SLOT[1] 2 3 4:DCCustom? [:SOURce]:RADio:TETRa:SLOT[1] 2 3 4:DCNormal[:DATA] P8 [:SOURce]:RADio:TETRa:SLOT[1] 2 3 4:DCNormal[:DATA]? [:SOURce]:RADio:TETRa:SLOT[1] 2 3 4:DCSync[:DATA] P8 [:SOURce]:RADio:TETRa:SLOT[1] 2 3 4:DCSync[:DATA]? [:SOURce]:RADio:TETRa:SLOT[1] 2 3 4:DDCustom[:DATA] P8 [:SOURce]:RADio:TETRa:SLOT[1] 2 3 4:DDCustom[:DATA]? [:SOURce]:RADio:TETRa:SLOT[1] 2 3 4:DDNormal[:DATA] P8 [:SOURce]:RADio:TETRa:SLOT[1] 2 3 4:DDNormal[:DATA]? [:SOURce]:RADio:TETRa:SLOT[1] 2 3 4:DDSync[:DATA] P8 [:SOURce]:RADio:TETRa:SLOT[1] 2 3 4:DDSync[:DATA]? [:SOURce]:RADio:TETRa:SLOT[1] 2 3 4:UC1[:DATA] P8 [:SOURce]:RADio:TETRa:SLOT[1] 2 3 4:UC1[:DATA]? [:SOURce]:RADio:TETRa:SLOT[1] 2 3 4:UC2[:DATA] P8 [:SOURce]:RADio:TETRa:SLOT[1] 2 3 4:UC2[:DATA]? [:SOURce]:RADio:TETRa:SLOT[1] 2 3 4:UCUStom P8 [:SOURce]:RADio:TETRa:SLOT[1] 2 3 4:UCUStom? [:SOURce]:RADio:TETRa:SLOT[1] 2 3 4:UNORmal[:DATA] P8 [:SOURce]:RADio:TETRa:SLOT[1] 2 3 4:UNORmal[:DATA]?</pre>
8-Lvl FSK	<pre>[:SOURce]:RADio:CUSTom:MODulation[:TYPE] FSK8 [:SOURce]:RADio:CUSTom:MODulation[:TYPE]?</pre>
	<pre>[:SOURce]:RADio:<desired format>:MODulation[:TYPE] FSK8 [:SOURce]:RADio:<desired format>:MODulation[:TYPE]?</pre>
8PSK	<pre>[:SOURce]:RADio:CUSTom:MODulation[:TYPE] PSK8 [:SOURce]:RADio:CUSTom:MODulation[:TYPE]?</pre>
	<pre>[:SOURce]:RADio:<desired format>:MODulation[:TYPE] PSK8 [:SOURce]:RADio:<desired format>:MODulation[:TYPE]?</pre>
16 1's & 16 0's	<pre>[:SOURce]:RADio:CUSTom:DATA P16 [:SOURce]:RADio:CUSTom:DATA? [:SOURce]:RADio:<desired format>:DATA P16 [:SOURce]:RADio:<desired format>:DATA?</pre>

Key	SCPI Command
16 1's & 16 0's continued	<pre>[:SOURce]:RADio:DECT:PPart:SLOT0 [1] 2 3 4 5 6 7 8 9 10 11:CUSTom P16 [:SOURce]:RADio:DECT:PPart:SLOT0 [1] 2 3 4 5 6 7 8 9 10 11:CUSTom?</pre>
	<pre>[:SOURce]:RADio:DECT:PPart:SLOT0 [1] 2 3 4 5 6 7 8 9 10 11:LCAPacity [:B] P16 [:SOURce]:RADio:DECT:PPart:SLOT0 [1] 2 3 4 5 6 7 8 9 10 11:LCAPacity[:B]?</pre>
	<pre>[:SOURce]:RADio:DECT:PPart:SLOT0 [1] 2 3 4 5 6 7 8 9 10 11:TRAFfic [:B] P16 [:SOURce]:RADio:DECT:PPart:SLOT0 [1] 2 3 4 5 6 7 8 9 10 11:TRAFfic[:B]?</pre>
	<pre>[:SOURce]:RADio:DECT:PPart:SLOT0 [1] 2 3 4 5 6 7 8 9 10 11:ZLCapacity [:B] P16 [:SOURce]:RADio:DECT:PPart:SLOT0 [1] 2 3 4 5 6 7 8 9 10 11:ZLCapacity[:B]?</pre>
	<pre>[:SOURce]:RADio:DECT:PPart:SLOT0 [1] 2 3 4 5 6 7 8 9 10 11:ZTRaffic [:B] P16 [:SOURce]:RADio:DECT:PPart:SLOT0 [1] 2 3 4 5 6 7 8 9 10 11:ZTRaffic[:B]?</pre>
	<pre>[:SOURce]:RADio:DECT:RFPart:SLOT0 [1] 2 3 4 5 6 7 8 9 10 11:CUSTom P16 [:SOURce]:RADio:DECT:RFPart:SLOT0 [1] 2 3 4 5 6 7 8 9 10 11:CUSTom?</pre>
	<pre>[:SOURce]:RADio:DECT:RFPart:SLOT0 [1] 2 3 4 5 6 7 8 9 10 11:LCAPacity [:B] P16 [:SOURce]:RADio:DECT:RFPart:SLOT0 [1] 2 3 4 5 6 7 8 9 10 11:LCAPacity[:B]?</pre>
	<pre>[:SOURce]:RADio:DECT:RFPart:SLOT0 [1] 2 3 4 5 6 7 8 9 10 11:TRAFfic [:B] P16 [:SOURce]:RADio:DECT:RFPart:SLOT0 [1] 2 3 4 5 6 7 8 9 10 11:TRAFfic[:B]?</pre>
	<pre>[:SOURce]:RADio:DECT:RFPart:SLOT0 [1] 2 3 4 5 6 7 8 9 10 11:ZLCapacity [:B] P16 [:SOURce]:RADio:DECT:RFPart:SLOT0 [1] 2 3 4 5 6 7 8 9 10 11:ZLCapacity[:B]?</pre>
	<pre>[:SOURce]:RADio:DECT:RFPart:SLOT0 [1] 2 3 4 5 6 7 8 9 10 11:ZTRaffic [:B] P16 [:SOURce]:RADio:DECT:RFPart:SLOT0 [1] 2 3 4 5 6 7 8 9 10 11:ZTRaffic[:B]?</pre>
	<pre>[:SOURce]:RADio:EDGE:SLOT0 [1] 2 3 4 5 6 7:CUSTom P16 [:SOURce]:RADio:EDGE:SLOT0 [1] 2 3 4 5 6 7:CUSTom? [:SOURce]:RADio:EDGE:SLOT0 [1] 2 3 4 5 6 7:NORMal:ENCRyption P16 [:SOURce]:RADio:EDGE:SLOT0 [1] 2 3 4 5 6 7:NORMal:ENCRyption?</pre>

Key	SCPI Command
16 1's & 16 0's continued	[:SOURce]:RADio:GSM:SLOT0 [1] 2 3 4 5 6 7:ACCEss:ENCRyption P16 [:SOURce]:RADio:GSM:SLOT0 [1] 2 3 4 5 6 7:ACCEss:ENCRyption?
	[:SOURce]:RADio:GSM:SLOT0 [1] 2 3 4 5 6 7:CUSTom P16 [:SOURce]:RADio:GSM:SLOT0 [1] 2 3 4 5 6 7:CUSTom?
	[:SOURce]:RADio:GSM:SLOT0 [1] 2 3 4 5 6 7:NORMal:ENCRyption P16 [:SOURce]:RADio:GSM:SLOT0 [1] 2 3 4 5 6 7:NORMal:ENCRyption?
	[:SOURce]:RADio:GSM:SLOT0 [1] 2 3 4 5 6 7:SYNC:ENCRyption P16 [:SOURce]:RADio:GSM:SLOT0 [1] 2 3 4 5 6 7:SYNC:ENCRyption?
	[:SOURce]:RADio[:NADC]:SLOT[1] 2 3 4 5 6:DCUStom P16 [:SOURce]:RADio[:NADC]:SLOT[1] 2 3 4 5 6:DCUStom?
	[:SOURce]:RADio[:NADC]:SLOT[1] 2 3 4 5 6:DTCHannel[:DATA] P16 [:SOURce]:RADio[:NADC]:SLOT[1] 2 3 4 5 6:DTCHannel[:DATA]?
	[:SOURce]:RADio[:NADC]:SLOT[1] 2 3 4 5 6:UCUStom P16 [:SOURce]:RADio[:NADC]:SLOT[1] 2 3 4 5 6:UCUStom?
	[:SOURce]:RADio[:NADC]:SLOT[1] 2 3 4 5 6:UTCHannel[:DATA] P16 [:SOURce]:RADio[:NADC]:SLOT[1] 2 3 4 5 6:UTCHannel[:DATA]?
	[:SOURce]:RADio:PDC:SLOT0 [1] 2 3 4 5:DCUStom P16 [:SOURce]:RADio:PDC:SLOT0 [1] 2 3 4 5:DCUStom?
	[:SOURce]:RADio:PDC:SLOT0 [1] 2 3 4 5:DTCHannel[:TCHannel] P16 [:SOURce]:RADio:PDC:SLOT0 [1] 2 3 4 5:DTCHannel[:TCHannel]?
	[:SOURce]:RADio:PDC:SLOT0 [1] 2 3 4 5:UCUStom P16 [:SOURce]:RADio:PDC:SLOT0 [1] 2 3 4 5:UCUStom?
	[:SOURce]:RADio:PDC:SLOT0 [1] 2 3 4 5:UTCHannel[:TCHannel] P16 [:SOURce]:RADio:PDC:SLOT0 [1] 2 3 4 5:UTCHannel[:TCHannel]?
	[:SOURce]:RADio:PHS:DLINK:SLOT[1] 2 3 4:CUSTom P16 [:SOURce]:RADio:PHS:DLINK:SLOT[1] 2 3 4:CUSTom?
	[:SOURce]:RADio:PHS:DLINK:SLOT[1] 2 3 4:TCHannel[:TCHannel] P16 [:SOURce]:RADio:PHS:DLINK:SLOT[1] 2 3 4:TCHannel[:TCHannel]?
	[:SOURce]:RADio:PHS:ULINK:SLOT[1] 2 3 4:CUSTom P16 [:SOURce]:RADio:PHS:ULINK:SLOT[1] 2 3 4:CUSTom?
	[:SOURce]:RADio:PHS:ULINK:SLOT[1] 2 3 4:TCHannel[:TCHannel] P16 [:SOURce]:RADio:PHS:ULINK:SLOT[1] 2 3 4:TCHannel[:TCHannel]?

Key	SCPI Command
16 1's & 16 0's continued	<pre>[:SOURCE]:RADio:TETRa:SLOT[1] 2 3 4:DCCustom P16 [:SOURCE]:RADio:TETRa:SLOT[1] 2 3 4:DCCustom? [:SOURCE]:RADio:TETRa:SLOT[1] 2 3 4:DCNormal[:DATA] P16 [:SOURCE]:RADio:TETRa:SLOT[1] 2 3 4:DCNormal[:DATA]? [:SOURCE]:RADio:TETRa:SLOT[1] 2 3 4:DCSync[:DATA] P16 [:SOURCE]:RADio:TETRa:SLOT[1] 2 3 4:DCSync[:DATA]? [:SOURCE]:RADio:TETRa:SLOT[1] 2 3 4:DDCustom[:DATA] P16 [:SOURCE]:RADio:TETRa:SLOT[1] 2 3 4:DDCustom[:DATA]? [:SOURCE]:RADio:TETRa:SLOT[1] 2 3 4:DDNormal[:DATA] P16 [:SOURCE]:RADio:TETRa:SLOT[1] 2 3 4:DDNormal[:DATA]? [:SOURCE]:RADio:TETRa:SLOT[1] 2 3 4:DDSync[:DATA] P16 [:SOURCE]:RADio:TETRa:SLOT[1] 2 3 4:DDSync[:DATA]? [:SOURCE]:RADio:TETRa:SLOT[1] 2 3 4:UC1[:DATA] P16 [:SOURCE]:RADio:TETRa:SLOT[1] 2 3 4:UC1[:DATA]? [:SOURCE]:RADio:TETRa:SLOT[1] 2 3 4:UC2[:DATA] P16 [:SOURCE]:RADio:TETRa:SLOT[1] 2 3 4:UC2[:DATA]? [:SOURCE]:RADio:TETRa:SLOT[1] 2 3 4:UCUStom P16 [:SOURCE]:RADio:TETRa:SLOT[1] 2 3 4:UCUStom? [:SOURCE]:RADio:TETRa:SLOT[1] 2 3 4:UNORmal[:DATA] P16 [:SOURCE]:RADio:TETRa:SLOT[1] 2 3 4:UNORmal[:DATA]?</pre>
16-Lvl FSK	<pre>[:SOURCE]:RADio:CUSTom:MODulation[:TYPE] FSK16 [:SOURCE]:RADio:CUSTom:MODulation[:TYPE]? [:SOURCE]:RADio:<desired format>:MODulation[:TYPE] FSK16 [:SOURCE]:RADio:<desired format>:MODulation[:TYPE]?</pre>
16PSK	<pre>[:SOURCE]:RADio:CUSTom:MODulation[:TYPE] PSK16 [:SOURCE]:RADio:CUSTom:MODulation[:TYPE]? [:SOURCE]:RADio:<desired format>:MODulation[:TYPE] PSK16 [:SOURCE]:RADio:<desired format>:MODulation[:TYPE]?</pre>
16QAM	<pre>[:SOURCE]:RADio:CUSTom:MODulation[:TYPE] QAM16 [:SOURCE]:RADio:CUSTom:MODulation[:TYPE]? [:SOURCE]:RADio:<desired format>:MODulation[:TYPE] QAM16 [:SOURCE]:RADio:<desired format>:MODulation[:TYPE]?</pre>
32 1's & 32 0's	<pre>[:SOURCE]:RADio:CUSTom:DATA P32 [:SOURCE]:RADio:CUSTom:DATA? [:SOURCE]:RADio:<desired format>:DATA P32 [:SOURCE]:RADio:<desired format>:DATA?</pre>

Key	SCPI Command
32 1's & 32 0's continued	[:SOURCE]:RADio:DECT:PPart:SLOT0 [1] 2 3 4 5 6 7 8 9 10 11:CUSTom P32 [:SOURCE]:RADio:DECT:PPart:SLOT0 [1] 2 3 4 5 6 7 8 9 10 11:CUSTom?
	[:SOURCE]:RADio:DECT:PPart:SLOT0 [1] 2 3 4 5 6 7 8 9 10 11:LCAPacity [:B] P32 [:SOURCE]:RADio:DECT:PPart:SLOT0 [1] 2 3 4 5 6 7 8 9 10 11:LCAPacity[:B]?
	[:SOURCE]:RADio:DECT:PPart:SLOT0 [1] 2 3 4 5 6 7 8 9 10 11:TRAFfic [:B] P32 [:SOURCE]:RADio:DECT:PPart:SLOT0 [1] 2 3 4 5 6 7 8 9 10 11:TRAFfic[:B]?
	[:SOURCE]:RADio:DECT:PPart:SLOT0 [1] 2 3 4 5 6 7 8 9 10 11:ZLCapacity [:B] P32 [:SOURCE]:RADio:DECT:PPart:SLOT0 [1] 2 3 4 5 6 7 8 9 10 11:ZLCapacity[:B]?
	[:SOURCE]:RADio:DECT:PPart:SLOT0 [1] 2 3 4 5 6 7 8 9 10 11:ZTRAffic [:B] P32 [:SOURCE]:RADio:DECT:PPart:SLOT0 [1] 2 3 4 5 6 7 8 9 10 11:ZTRAffic[:B]?
	[:SOURCE]:RADio:DECT:RFPart:SLOT0 [1] 2 3 4 5 6 7 8 9 10 11:CUSTom P32 [:SOURCE]:RADio:DECT:RFPart:SLOT0 [1] 2 3 4 5 6 7 8 9 10 11:CUSTom?
	[:SOURCE]:RADio:DECT:RFPart:SLOT0 [1] 2 3 4 5 6 7 8 9 10 11:LCAPacity [:B] P32 [:SOURCE]:RADio:DECT:RFPart:SLOT0 [1] 2 3 4 5 6 7 8 9 10 11:LCAPacity[:B]?
	[:SOURCE]:RADio:DECT:RFPart:SLOT0 [1] 2 3 4 5 6 7 8 9 10 11:TRAFfic [:B] P32 [:SOURCE]:RADio:DECT:RFPart:SLOT0 [1] 2 3 4 5 6 7 8 9 10 11:TRAFfic[:B]?
	[:SOURCE]:RADio:DECT:RFPart:SLOT0 [1] 2 3 4 5 6 7 8 9 10 11:ZLCapacity [:B] P32 [:SOURCE]:RADio:DECT:RFPart:SLOT0 [1] 2 3 4 5 6 7 8 9 10 11:ZLCapacity[:B]?
	[:SOURCE]:RADio:DECT:RFPart:SLOT0 [1] 2 3 4 5 6 7 8 9 10 11:ZTRAffic [:B] P32 [:SOURCE]:RADio:DECT:RFPart:SLOT0 [1] 2 3 4 5 6 7 8 9 10 11:ZTRAffic[:B]?
	[:SOURCE]:RADio:EDGE:SLOT0 [1] 2 3 4 5 6 7:CUSTom P32 [:SOURCE]:RADio:EDGE:SLOT0 [1] 2 3 4 5 6 7:CUSTom? [:SOURCE]:RADio:EDGE:SLOT0 [1] 2 3 4 5 6 7:NORMAl:ENCRyption P32 [:SOURCE]:RADio:EDGE:SLOT0 [1] 2 3 4 5 6 7:NORMAl:ENCRyption?

Key	SCPI Command
32 1's & 32 0's continued	<pre>[:SOURce]:RADio:GSM:SLOT0 [1] 2 3 4 5 6 7:ACCEss:ENCRyption P32 [:SOURce]:RADio:GSM:SLOT0 [1] 2 3 4 5 6 7:ACCEss:ENCRyption? [:SOURce]:RADio:GSM:SLOT0 [1] 2 3 4 5 6 7:CUSTom P32 [:SOURce]:RADio:GSM:SLOT0 [1] 2 3 4 5 6 7:CUSTom? [:SOURce]:RADio:GSM:SLOT0 [1] 2 3 4 5 6 7:NORMal:ENCRyption P32 [:SOURce]:RADio:GSM:SLOT0 [1] 2 3 4 5 6 7:NORMal:ENCRyption? [:SOURce]:RADio:GSM:SLOT0 [1] 2 3 4 5 6 7:SYNC:ENCRyption P32 [:SOURce]:RADio:GSM:SLOT0 [1] 2 3 4 5 6 7:SYNC:ENCRyption?</pre>
	<pre>[:SOURce]:RADio[:NADC]:SLOT[1] 2 3 4 5 6:DCUStom P32 [:SOURce]:RADio[:NADC]:SLOT[1] 2 3 4 5 6:DCUStom? [:SOURce]:RADio[:NADC]:SLOT[1] 2 3 4 5 6:DTCHannel[:DATA] P32 [:SOURce]:RADio[:NADC]:SLOT[1] 2 3 4 5 6:DTCHannel[:DATA]? [:SOURce]:RADio[:NADC]:SLOT[1] 2 3 4 5 6:UCUStom P32 [:SOURce]:RADio[:NADC]:SLOT[1] 2 3 4 5 6:UCUStom? [:SOURce]:RADio[:NADC]:SLOT[1] 2 3 4 5 6:UTCHannel[:DATA] P32 [:SOURce]:RADio[:NADC]:SLOT[1] 2 3 4 5 6:UTCHannel[:DATA]?</pre>
	<pre>[:SOURce]:RADio:PDC:SLOT0 [1] 2 3 4 5:DCUStom P32 [:SOURce]:RADio:PDC:SLOT0 [1] 2 3 4 5:DCUStom? [:SOURce]:RADio:PDC:SLOT0 [1] 2 3 4 5:DTCHannel[:TCHannel] P32 [:SOURce]:RADio:PDC:SLOT0 [1] 2 3 4 5:DTCHannel[:TCHannel]? [:SOURce]:RADio:PDC:SLOT0 [1] 2 3 4 5:UCUStom P32 [:SOURce]:RADio:PDC:SLOT0 [1] 2 3 4 5:UCUStom? [:SOURce]:RADio:PDC:SLOT0 [1] 2 3 4 5:UTCHannel[:TCHannel] P32 [:SOURce]:RADio:PDC:SLOT0 [1] 2 3 4 5:UTCHannel[:TCHannel]?</pre>
	<pre>[:SOURce]:RADio:PHS:DLINK:SLOT[1] 2 3 4:CUSTom P32 [:SOURce]:RADio:PHS:DLINK:SLOT[1] 2 3 4:CUSTom? [:SOURce]:RADio:PHS:DLINK:SLOT[1] 2 3 4:TCHannel[:TCHannel] P32 [:SOURce]:RADio:PHS:DLINK:SLOT[1] 2 3 4:TCHannel[:TCHannel]? [:SOURce]:RADio:PHS:ULINK:SLOT[1] 2 3 4:CUSTom P32 [:SOURce]:RADio:PHS:ULINK:SLOT[1] 2 3 4:CUSTom? [:SOURce]:RADio:PHS:ULINK:SLOT[1] 2 3 4:TCHannel[:TCHannel] P32 [:SOURce]:RADio:PHS:ULINK:SLOT[1] 2 3 4:TCHannel[:TCHannel]?</pre>

Key	SCPI Command
32 1's & 32 0's continued	<pre>[:SOURce]:RADio:TETRa:SLOT[1] 2 3 4:DCCustom P32 [:SOURce]:RADio:TETRa:SLOT[1] 2 3 4:DCCustom? [:SOURce]:RADio:TETRa:SLOT[1] 2 3 4:DCNormal[:DATA] P32 [:SOURce]:RADio:TETRa:SLOT[1] 2 3 4:DCNormal[:DATA]? [:SOURce]:RADio:TETRa:SLOT[1] 2 3 4:DCSync[:DATA] P32 [:SOURce]:RADio:TETRa:SLOT[1] 2 3 4:DCSync[:DATA]? [:SOURce]:RADio:TETRa:SLOT[1] 2 3 4:DDCustom[:DATA] P32 [:SOURce]:RADio:TETRa:SLOT[1] 2 3 4:DDCustom[:DATA]? [:SOURce]:RADio:TETRa:SLOT[1] 2 3 4:DDNormal[:DATA] P32 [:SOURce]:RADio:TETRa:SLOT[1] 2 3 4:DDNormal[:DATA]? [:SOURce]:RADio:TETRa:SLOT[1] 2 3 4:DDSync[:DATA] P32 [:SOURce]:RADio:TETRa:SLOT[1] 2 3 4:DDSync[:DATA]? [:SOURce]:RADio:TETRa:SLOT[1] 2 3 4:UC1[:DATA] P32 [:SOURce]:RADio:TETRa:SLOT[1] 2 3 4:UC1[:DATA]? [:SOURce]:RADio:TETRa:SLOT[1] 2 3 4:UC2[:DATA] P32 [:SOURce]:RADio:TETRa:SLOT[1] 2 3 4:UC2[:DATA]? [:SOURce]:RADio:TETRa:SLOT[1] 2 3 4:UCUStom P32 [:SOURce]:RADio:TETRa:SLOT[1] 2 3 4:UCUStom? [:SOURce]:RADio:TETRa:SLOT[1] 2 3 4:UNORmal[:DATA] P32 [:SOURce]:RADio:TETRa:SLOT[1] 2 3 4:UNORmal[:DATA]?</pre>
32QAM	<pre>[:SOURce]:RADio:CUSTom:MODulation[:TYPE] QAM32 [:SOURce]:RADio:CUSTom:MODulation[:TYPE]? [:SOURce]:RADio:<desired format>:MODulation[:TYPE] QAM32 [:SOURce]:RADio:<desired format>:MODulation[:TYPE]?</pre>
64 1's & 64 0's	<pre>[:SOURce]:RADio:CUSTom:DATA P64 [:SOURce]:RADio:CUSTom:DATA? [:SOURce]:RADio:<desired format>:DATA P64 [:SOURce]:RADio:<desired format>:DATA?</pre>

Key	SCPI Command
<p>64 1's & 64 0's continued</p>	<pre>[:SOURce]:RADio:DECT:PPart:SLOT0 [1] 2 3 4 5 6 7 8 9 10 11:CUSTom P64 [:SOURce]:RADio:DECT:PPart:SLOT0 [1] 2 3 4 5 6 7 8 9 10 11:CUSTom? [:SOURce]:RADio:DECT:PPart:SLOT0 [1] 2 3 4 5 6 7 8 9 10 11:LCAPacity [:B] P64 [:SOURce]:RADio:DECT:PPart:SLOT0 [1] 2 3 4 5 6 7 8 9 10 11:LCAPacity[:B]? [:SOURce]:RADio:DECT:PPart:SLOT0 [1] 2 3 4 5 6 7 8 9 10 11:TRAFfic [:B] P64 [:SOURce]:RADio:DECT:PPart:SLOT0 [1] 2 3 4 5 6 7 8 9 10 11:TRAFfic[:B]? [:SOURce]:RADio:DECT:PPart:SLOT0 [1] 2 3 4 5 6 7 8 9 10 11:ZLCapacity [:B] P64 [:SOURce]:RADio:DECT:PPart:SLOT0 [1] 2 3 4 5 6 7 8 9 10 11:ZLCapacity[:B]? [:SOURce]:RADio:DECT:PPart:SLOT0 [1] 2 3 4 5 6 7 8 9 10 11:ZTRaffic [:B] P64 [:SOURce]:RADio:DECT:PPart:SLOT0 [1] 2 3 4 5 6 7 8 9 10 11:ZTRaffic[:B]? [:SOURce]:RADio:DECT:RFPart:SLOT0 [1] 2 3 4 5 6 7 8 9 10 11:CUSTom P64 [:SOURce]:RADio:DECT:RFPart:SLOT0 [1] 2 3 4 5 6 7 8 9 10 11:CUSTom? [:SOURce]:RADio:DECT:RFPart:SLOT0 [1] 2 3 4 5 6 7 8 9 10 11:LCAPacity [:B] P64 [:SOURce]:RADio:DECT:RFPart:SLOT0 [1] 2 3 4 5 6 7 8 9 10 11:LCAPacity[:B]? [:SOURce]:RADio:DECT:RFPart:SLOT0 [1] 2 3 4 5 6 7 8 9 10 11:TRAFfic [:B] P64 [:SOURce]:RADio:DECT:RFPart:SLOT0 [1] 2 3 4 5 6 7 8 9 10 11:TRAFfic[:B]? [:SOURce]:RADio:DECT:RFPart:SLOT0 [1] 2 3 4 5 6 7 8 9 10 11:ZLCapacity [:B] P64 [:SOURce]:RADio:DECT:RFPart:SLOT0 [1] 2 3 4 5 6 7 8 9 10 11:ZLCapacity[:B]? [:SOURce]:RADio:DECT:RFPart:SLOT0 [1] 2 3 4 5 6 7 8 9 10 11:ZTRaffic [:B] P64 [:SOURce]:RADio:DECT:RFPart:SLOT0 [1] 2 3 4 5 6 7 8 9 10 11:ZTRaffic[:B]?</pre>
	<pre>[:SOURce]:RADio:EDGE:SLOT0 [1] 2 3 4 5 6 7:CUSTom P64 [:SOURce]:RADio:EDGE:SLOT0 [1] 2 3 4 5 6 7:CUSTom? [:SOURce]:RADio:EDGE:SLOT0 [1] 2 3 4 5 6 7:NORMal:ENCRyption P64 [:SOURce]:RADio:EDGE:SLOT0 [1] 2 3 4 5 6 7:NORMal:ENCRyption?</pre>

Key	SCPI Command
64 1's & 64 0's continued	[:SOURce]:RADio:GSM:SLOT0 [1] 2 3 4 5 6 7:ACCEss:ENCRyption P64 [:SOURce]:RADio:GSM:SLOT0 [1] 2 3 4 5 6 7:ACCEss:ENCRyption?
	[:SOURce]:RADio:GSM:SLOT0 [1] 2 3 4 5 6 7:CUSTom P64 [:SOURce]:RADio:GSM:SLOT0 [1] 2 3 4 5 6 7:CUSTom?
	[:SOURce]:RADio:GSM:SLOT0 [1] 2 3 4 5 6 7:NORMal:ENCRyption P64 [:SOURce]:RADio:GSM:SLOT0 [1] 2 3 4 5 6 7:NORMal:ENCRyption?
	[:SOURce]:RADio:GSM:SLOT0 [1] 2 3 4 5 6 7:SYNC:ENCRyption P64 [:SOURce]:RADio:GSM:SLOT0 [1] 2 3 4 5 6 7:SYNC:ENCRyption?
	[:SOURce]:RADio[:NADC]:SLOT[1] 2 3 4 5 6:DCUStom P64 [:SOURce]:RADio[:NADC]:SLOT[1] 2 3 4 5 6:DCUStom?
	[:SOURce]:RADio[:NADC]:SLOT[1] 2 3 4 5 6:DTCHannel[:DATA] P64 [:SOURce]:RADio[:NADC]:SLOT[1] 2 3 4 5 6:DTCHannel[:DATA]?
	[:SOURce]:RADio[:NADC]:SLOT[1] 2 3 4 5 6:UCUStom P64 [:SOURce]:RADio[:NADC]:SLOT[1] 2 3 4 5 6:UCUStom?
	[:SOURce]:RADio[:NADC]:SLOT[1] 2 3 4 5 6:UTCHannel[:DATA] P64 [:SOURce]:RADio[:NADC]:SLOT[1] 2 3 4 5 6:UTCHannel[:DATA]?
	[:SOURce]:RADio:PDC:SLOT0 [1] 2 3 4 5:DCUStom P64 [:SOURce]:RADio:PDC:SLOT0 [1] 2 3 4 5:DCUStom?
	[:SOURce]:RADio:PDC:SLOT0 [1] 2 3 4 5:DTCHannel[:TCHannel] P64 [:SOURce]:RADio:PDC:SLOT0 [1] 2 3 4 5:DTCHannel[:TCHannel]?
	[:SOURce]:RADio:PDC:SLOT0 [1] 2 3 4 5:UCUStom P64 [:SOURce]:RADio:PDC:SLOT0 [1] 2 3 4 5:UCUStom?
	[:SOURce]:RADio:PDC:SLOT0 [1] 2 3 4 5:UTCHannel[:TCHannel] P64 [:SOURce]:RADio:PDC:SLOT0 [1] 2 3 4 5:UTCHannel[:TCHannel]?
	[:SOURce]:RADio:PHS:DLINK:SLOT[1] 2 3 4:CUSTom P64 [:SOURce]:RADio:PHS:DLINK:SLOT[1] 2 3 4:CUSTom?
	[:SOURce]:RADio:PHS:DLINK:SLOT[1] 2 3 4:TCHannel[:TCHannel] P64 [:SOURce]:RADio:PHS:DLINK:SLOT[1] 2 3 4:TCHannel[:TCHannel]?
	[:SOURce]:RADio:PHS:ULINK:SLOT[1] 2 3 4:CUSTom P64 [:SOURce]:RADio:PHS:ULINK:SLOT[1] 2 3 4:CUSTom?
	[:SOURce]:RADio:PHS:ULINK:SLOT[1] 2 3 4:TCHannel[:TCHannel] P64 [:SOURce]:RADio:PHS:ULINK:SLOT[1] 2 3 4:TCHannel[:TCHannel]?

Key	SCPI Command
64 1's & 64 0's continued	<pre>[:SOURCE]:RADio:TETRa:SLOT[1] 2 3 4:DCCustom P64 [:SOURCE]:RADio:TETRa:SLOT[1] 2 3 4:DCCustom? [:SOURCE]:RADio:TETRa:SLOT[1] 2 3 4:DCNormal[:DATA] P64 [:SOURCE]:RADio:TETRa:SLOT[1] 2 3 4:DCNormal[:DATA]? [:SOURCE]:RADio:TETRa:SLOT[1] 2 3 4:DCSync[:DATA] P64 [:SOURCE]:RADio:TETRa:SLOT[1] 2 3 4:DCSync[:DATA]? [:SOURCE]:RADio:TETRa:SLOT[1] 2 3 4:DDCustom[:DATA] P64 [:SOURCE]:RADio:TETRa:SLOT[1] 2 3 4:DDCustom[:DATA]? [:SOURCE]:RADio:TETRa:SLOT[1] 2 3 4:DDNormal[:DATA] P64 [:SOURCE]:RADio:TETRa:SLOT[1] 2 3 4:DDNormal[:DATA]? [:SOURCE]:RADio:TETRa:SLOT[1] 2 3 4:DDSync[:DATA] P64 [:SOURCE]:RADio:TETRa:SLOT[1] 2 3 4:DDSync[:DATA]? [:SOURCE]:RADio:TETRa:SLOT[1] 2 3 4:UC1[:DATA] P64 [:SOURCE]:RADio:TETRa:SLOT[1] 2 3 4:UC1[:DATA]? [:SOURCE]:RADio:TETRa:SLOT[1] 2 3 4:UC2[:DATA] P64 [:SOURCE]:RADio:TETRa:SLOT[1] 2 3 4:UC2[:DATA]? [:SOURCE]:RADio:TETRa:SLOT[1] 2 3 4:UCUStom P64 [:SOURCE]:RADio:TETRa:SLOT[1] 2 3 4:UCUStom? [:SOURCE]:RADio:TETRa:SLOT[1] 2 3 4:UNORmal[:DATA] P64 [:SOURCE]:RADio:TETRa:SLOT[1] 2 3 4:UNORmal[:DATA]?</pre>
64QAM	<pre>[:SOURCE]:RADio:CUSTom:MODulation[:TYPE] QAM64 [:SOURCE]:RADio:CUSTom:MODulation[:TYPE]? [:SOURCE]:RADio:<desired format>:MODulation[:TYPE] QAM64 [:SOURCE]:RADio:<desired format>:MODulation[:TYPE]?</pre>
256QAM	<pre>[:SOURCE]:RADio:CUSTom:MODulation[:TYPE] QAM256 [:SOURCE]:RADio:CUSTom:MODulation[:TYPE]? [:SOURCE]:RADio:<desired format>:MODulation[:TYPE] QAM256 [:SOURCE]:RADio:<desired format>:MODulation[:TYPE]?</pre>
800MHz Base	<pre>[:SOURCE]:RADio:PDC:FCHannel:BAND B8 [:SOURCE]:RADio:PDC:FCHannel:BAND?</pre>
800MHz Mobile	<pre>[:SOURCE]:RADio:PDC:FCHannel:BAND M8 [:SOURCE]:RADio:PDC:FCHannel:BAND?</pre>
1500MHz Base	<pre>[:SOURCE]:RADio:PDC:FCHannel:BAND B15 [:SOURCE]:RADio:PDC:FCHannel:BAND?</pre>
1500MHz Mobile	<pre>[:SOURCE]:RADio:PDC:FCHannel:BAND M15 [:SOURCE]:RADio:PDC:FCHannel:BAND?</pre>

Key	SCPI Command
A field	<pre>[:SOURCE]:RADio:DECT:PPart:SLOT0 [1] 2 3 4 5 6 7 8 9 10 11:LCAPacity: A <64-bit value> [:SOURCE]:RADio:DECT:PPart:SLOT0 [1] 2 3 4 5 6 7 8 9 10 11:LCAPacity:A? [:SOURCE]:RADio:DECT:RFPart:SLOT0 [1] 2 3 4 5 6 7 8 9 10 11:ZTRAffic: A <64-bit value> [:SOURCE]:RADio:DECT:RFPart:SLOT0 [1] 2 3 4 5 6 7 8 9 10 11:ZTRAffic:A? [:SOURCE]:RADio:DECT:PPart:SLOT0 [1] 2 3 4 5 6 7 8 9 10 11:TRAFfic: A <64-bit value> [:SOURCE]:RADio:DECT:PPart:SLOT0 [1] 2 3 4 5 6 7 8 9 10 11:TRAFfic:A? [:SOURCE]:RADio:DECT:PPart:SLOT0 [1] 2 3 4 5 6 7 8 9 10 11:ZLCapacity: A <64-bit value> [:SOURCE]:RADio:DECT:PPart:SLOT0 [1] 2 3 4 5 6 7 8 9 10 11:ZLCapacity:A? [:SOURCE]:RADio:DECT:RFPart:SLOT0 [1] 2 3 4 5 6 7 8 9 10 11:DUMM[1]: A <64-bit value> [:SOURCE]:RADio:DECT:RFPart:SLOT0 [1] 2 3 4 5 6 7 8 9 10 11:DUMM[1]:A? [:SOURCE]:RADio:DECT:RFPart:SLOT0 [1] 2 3 4 5 6 7 8 9 10 11:DUMM2: A <64-bit value> [:SOURCE]:RADio:DECT:RFPart:SLOT0 [1] 2 3 4 5 6 7 8 9 10 11:DUMM2:A? [:SOURCE]:RADio:DECT:RFPart:SLOT0 [1] 2 3 4 5 6 7 8 9 10 11:LCAPacity: A <64-bit value> [:SOURCE]:RADio:DECT:RFPart:SLOT0 [1] 2 3 4 5 6 7 8 9 10 11:LCAPacity:A? [:SOURCE]:RADio:DECT:RFPart:SLOT0 [1] 2 3 4 5 6 7 8 9 10 11:TRAFfic: A <64-bit value> [:SOURCE]:RADio:DECT:RFPart:SLOT0 [1] 2 3 4 5 6 7 8 9 10 11:TRAFfic:A? [:SOURCE]:RADio:DECT:RFPart:SLOT0 [1] 2 3 4 5 6 7 8 9 10 11:ZLCapacity: A <64-bit value> [:SOURCE]:RADio:DECT:RFPart:SLOT0 [1] 2 3 4 5 6 7 8 9 10 11:ZLCapacity:A?</pre>
Access	<pre>[:SOURCE]:RADio:GSM:SLOT0 [1] 2 3 4 5 6 7[:TYPE] ACCess [:SOURCE]:RADio:GSM:SLOT0 [1] 2 3 4 5 6 7[:TYPE]?</pre>
All Timeslots	<pre>[:SOURCE]:RADio:<desired format>:SOUT ALL [:SOURCE]:RADio:<desired format>:SOUT?</pre>
APCO 25 C4FM	<pre>[SOURCE]:RADio:CUSTom:FILTer AC4FM [SOURCE]:RADio:CUSTom:FILTer? [SOURCE]:RADio:<desired format>:FILTer AC4FM [SOURCE]:RADio:<desired format>:FILTer?</pre>
APCO 25 w/C4FM	<pre>[:SOURCE]:RADio:CUSTom:STANdard:SElect C4Fm [:SOURCE]:RADio:CUSTom:STANdard:SElect? [SOURCE]:RADio:<desired format>:STANdard:SElect C4Fm [SOURCE]:RADio:<desired format>:STANdard:SElect?</pre>
APCO 25 w/CQPSK	<pre>[:SOURCE]:RADio:CUSTom:STANdard:SElect ACQPsk [:SOURCE]:RADio:CUSTom:STANdard:SElect?</pre>
B	<pre>[:SOURCE]:RADio:TETRa:SLOT[1] 2 3 4:DCSync:B <30-bit value> [:SOURCE]:RADio:TETRa:SLOT[1] 2 3 4:DCSync:B? [:SOURCE]:RADio:TETRa:SLOT[1] 2 3 4:DDSync:B <30 bit value> [:SOURCE]:RADio:TETRa:SLOT[1] 2 3 4:DDSync:B-</pre>

Key	SCPI Command
B1	<pre>[:SOURce]:RADIo:TETRA:SLOT[1] 2 3 4:DCNormal:B1 <14-bit value> [:SOURce]:RADIo:TETRA:SLOT[1] 2 3 4:DCNormal:B1? [:SOURce]:RADIo:TETRA:SLOT[1] 2 3 4:DDNormal:B1 <14-bit value> [:SOURce]:RADIo:TETRA:SLOT[1] 2 3 4:DDNormal:B1?</pre>
B2	<pre>[:SOURce]:RADIo:TETRA:SLOT[1] 2 3 4:DCNormal:B2 <16-bit value> [:SOURce]:RADIo:TETRA:SLOT[1] 2 3 4:DCNormal:B2? [:SOURce]:RADIo:TETRA:SLOT[1] 2 3 4:DDNormal:B2 <16-bit value> [:SOURce]:RADIo:TETRA:SLOT[1] 2 3 4:DDNormal:B2?</pre>
Base	<pre>[:SOURce]:RADIo[:NADC]:FCHannel:BASE [:SOURce]:RADIo[:NADC]:FCHannel:BASE?</pre>
B field	<pre>[:SOURce]:RADIo:DECT:PPart:SLOT0 [1] 2 3 4 5 6 7 8 9 10 11:LCAPacity:B PN9 PN15 FIX4 "<file name>" EXT FDEV1_HS FDEV1_FS FDEV2_FS FACCuracy DM1 DM0 P4 P8 P16 P32 P64 [:SOURce]:RADIo:DECT:PPart:SLOT0 [1] 2 3 4 5 6 7 8 9 10 11:LCAPacity:B? [:SOURce]:RADIo:DECT:PPart:SLOT0 [1] 2 3 4 5 6 7 8 9 10 11:TRAFFic:B PN9 PN15 FIX4 "<file name>" EXT FDEV1_HS FDEV1_FS FDEV2_FS FACCuracy DM1 DM0 P4 P8 P16 P32 P64 [:SOURce]:RADIo:DECT:PPart:SLOT0 [1] 2 3 4 5 6 7 8 9 10 11:TRAFFic:B? [:SOURce]:RADIo:DECT:PPart:SLOT0 [1] 2 3 4 5 6 7 8 9 10 11:ZLCapacity: B PN9 PN15 FIX4 "<file name>" EXT FDEV1_HS FDEV1_FS FDEV2_FS FACCuracy DM1 DM0 P4 P8 P16 P32 P64 [:SOURce]:RADIo:DECT:PPart:SLOT0 [1] 2 3 4 5 6 7 8 9 10 11:ZLCapacity:B? [:SOURce]:RADIo:DECT:PPart:SLOT0 [1] 2 3 4 5 6 7 8 9 10 11:ZTRAFFic:B PN9 PN15 FIX4 "<file name>" EXT FDEV1_HS FDEV1_FS FDEV2_FS FACCuracy DM1 DM0 P4 P8 P16 P32 P64 [:SOURce]:RADIo:DECT:PPart:SLOT0 [1] 2 3 4 5 6 7 8 9 10 11:ZTRAFFic:B? [:SOURce]:RADIo:DECT:RFPart:SLOT0 [1] 2 3 4 5 6 7 8 9 10 11:LCAPacity:B PN9 PN15 FIX4 "<file name>" EXT FDEV1_HS FDEV1_FS FDEV2_FS FACCuracy DM1 DM0 P4 P8 P16 P32 P64 [:SOURce]:RADIo:DECT:RFPart:SLOT0 [1] 2 3 4 5 6 7 8 9 10 11:LCAPacity:B? [:SOURce]:RADIo:DECT:RFPart:SLOT0 [1] 2 3 4 5 6 7 8 9 10 11:TRAFFic:B PN9 PN15 FIX4 "<file name>" EXT FDEV1_HS FDEV1_FS FDEV2_FS FACCuracy DM1 DM0 P4 P8 P16 P32 P64 [:SOURce]:RADIo:DECT:RFPart:SLOT0 [1] 2 3 4 5 6 7 8 9 10 11:TRAFFic:B? [:SOURce]:RADIo:DECT:RFPart:SLOT0 [1] 2 3 4 5 6 7 8 9 10 11:ZLCapacity: B PN9 PN15 FIX4 "<file name>" EXT FDEV1_HS FDEV1_FS FDEV2_FS FACCuracy DM1 DM0 P4 P8 P16 P32 P64 [:SOURce]:RADIo:DECT:RFPart:SLOT0 [1] 2 3 4 5 6 7 8 9 10 11:ZLCapacity:B? [:SOURce]:RADIo:DECT:RFPart:SLOT0 [1] 2 3 4 5 6 7 8 9 10 11:ZTRAFFic:B PN9 PN15 FIX4 "<file name>" EXT FDEV1_HS FDEV1_FS FDEV2_FS FACCuracy DM1 DM0 P4 P8 P16 P32 P64 [:SOURce]:RADIo:DECT:RFPart:SLOT0 [1] 2 3 4 5 6 7 8 9 10 11:ZTRAFFic:B?</pre>
BBG Data Clock Ext Int	<pre>[:SOURce]:RADIo:CUSTom:BBCLock INT[1] EXT[1] [:SOURce]:RADIo:CUSTom:BBCLock? [:SOURce]:RADIo:<desired format>:BBCLock INT[1] EXT[1] [:SOURce]:RADIo:<desired format>:BBCLock?</pre>

Key	SCPI Command
Begin Frame	[:SOURce]:RADio:<desired format>:SOUT FRAME [:SOURce]:RADio:<desired format>:SOUT?
Begin Timeslot	[:SOURce]:RADio:CUSTom:SOUT SLOT <value> [:SOURce]:RADio:CUSTom:SOUT?
	[:SOURce]:RADio:<desired format>:SOUT SLOT [:SOURce]:RADio:<desired format>:SOUT:SLOT <value> [:SOURce]:RADio:<desired format>:SOUT:SLOT?
Bit Clock	[:SOURce]:RADio:EDGE:BNCMux:DCOut BCLock [:SOURce]:RADio:EDGE:BNCMux:DCOut?
Bluetooth	[:SOURce]:RADio:CUSTom:STANdard:SElect BLUEtooth [:SOURce]:RADio:CUSTom:STANdard:SElect?
BNC MUX Settings	[:SOURce]:RADio:EDGE:BNCMux:DOut BCLock GCLock [:SOURce]:RADio:EDGE:BNCMux:DOut? [:SOURce]:RADio:EDGE:BNCMux:DCOut MDATa EDATa [:SOURce]:RADio:EDGE:BNCMux:DCOut? [:SOURce]:RADio:EDGE:BNCMux:EVENT MTRigger FTRigger [:SOURce]:RADio:EDGE:BNCMux:EVENT? [:SOURce]:RADio:EDGE:BNCMux:SSOut IGAT TBSync [:SOURce]:RADio:EDGE:BNCMux:SSOut?
BPSK	[:SOURce]:RADio:CUSTom:MODulation[:TYPE] BPSK [:SOURce]:RADio:CUSTom:MODulation[:TYPE]?
	[:SOURce]:RADio:<desired format>:MODulation[:TYPE] BPSK [:SOURce]:RADio:<desired format>:MODulation[:TYPE]?
Burst Shape Type	[:SOURce]:RADio:CUSTom:BURSt:SHAPE[:TYPE] SINE "<file name>" [:SOURce]:RADio:CUSTom:BURSt:SHAPE[:TYPE]? [:SOURce]:RADio:<desired format>:BURSt:SHAPE[:TYPE] SINE "<file name>" [:SOURce]:RADio:<desired format>:BURSt:SHAPE[:TYPE]?
Bus	[:SOURce]:RADio:CUSTom:TRIGger[:SOURce] BUS [:SOURce]:RADio:CUSTom:TRIGger[:SOURce]?
	[:SOURce]:RADio:<desired format>:TRIGger[:SOURce] BUS [:SOURce]:RADio:<desired format>:TRIGger[:SOURce]?
	[:SOURce]:RADio:<desired format>:SECondary:TRIGger[:SOURce] BUS [:SOURce]:RADio:<desired format>:SECondary:TRIGger[:SOURce]?
C4FM	[:SOURce]:RADio:CUSTom:MODulation[:TYPE] C4FM [:SOURce]:RADio:CUSTom:MODulation[:TYPE]?
	[:SOURce]:RADio:<desired format>:MODulation[:TYPE] C4FM [:SOURce]:RADio:<desired format>:MODulation[:TYPE]?

Key	SCPI Command
CC	<pre>[:SOURce]:RADio:PDC:SLOT0 [1] 2 3 4 5:DTCHannel:CCODE <bit pattern> [:SOURce]:RADio:PDC:SLOT0 [1] 2 3 4 5:DTCHannel:CCODE? [:SOURce]:RADio:PDC:SLOT0 [1] 2 3 4 5:UTCHannel:CCODE <bit pattern> [:SOURce]:RADio:PDC:SLOT0 [1] 2 3 4 5:UTCHannel:CCODE? [:SOURce]:RADio:PDC:SLOT0 [1] 2 3 4 5:UVOX:CCODE <bit pattern> [:SOURce]:RADio:PDC:SLOT0 [1] 2 3 4 5:UVOX:CCODE?</pre>
CDPD	<pre>[:SOURce]:RADio:CUSTom:STANdard:SElect CDPD [:SOURce]:RADio:CUSTom:STANdard:SElect?</pre>
CDL	<pre>[:SOURce]:RADio[:NADC]:SLOT[1] 2 3 4 5 6:DTCHannel:CDLocator <bit pattern> [:SOURce]:RADio[:NADC]:SLOT[1] 2 3 4 5 6:DTCHannel:CDLocator?</pre>
CDVCC	<pre>[:SOURce]:RADio[:NADC]:SLOT[1] 2 3 4 5 6:DTCHannel:CDVCCode <bit pattern> [:SOURce]:RADio[:NADC]:SLOT[1] 2 3 4 5 6:DTCHannel:CDVCCode? [:SOURce]:RADio[:NADC]:SLOT[1] 2 3 4 5 6:UTCHannel:CDVCCode <bit pattern> [:SOURce]:RADio[:NADC]:SLOT[1] 2 3 4 5 6:UTCHannel:CDVCCode?</pre>
CS-1	<pre>[:SOURce]:RADio:GSM:SLOT0 [1] 2 3 4 5 6 7:NORMal:ENCRyption CS1 [:SOURce]:RADio:GSM:SLOT0 [1] 2 3 4 5 6 7:NORMal:ENCRyption?</pre>
Channel Band	<pre>[:SOURce]:RADio:DECT PHS TETra:FCHannel:BAND STANdard [:SOURce]:RADio:DECT PHS TETra:FCHannel:BAND?</pre>
	<pre>[:SOURce]:RADio:EDGE GSM:FCHannel:BAND BPGSm MPGSm BEGSm MEGSm BRGSm MRGSm BDCS MDCS BPCS MPCS [:SOURce]:RADio:EDGE GSM:FCHannel:BAND?</pre>
	<pre>[:SOURce]:RADio[:NADC]:FCHannel:BAND BASE MOBile [:SOURce]:RADio[:NADC]:FCHannel:BAND?</pre>
	<pre>[:SOURce]:RADio:PDC:FCHannel:BAND B8 M8 B15 M15 [:SOURce]:RADio:PDC:FCHannel:BAND?</pre>
	<pre>[:SOURce]:RADio:PHS TETra:FCHannel:BAND STANdard [:SOURce]:RADio:PHS TETra:FCHannel:BAND?</pre>
Channel Number	<pre>[:SOURce]:RADio:<desired format>:FCHannel:NUMBer <number> [:SOURce]:RADio:<desired format>:FCHannel:NUMBer?</pre>

Key	SCPI Command
Configure Custom	[:SOURce]:RADio:DECT:PPart:SLOT0 [1] 2 3 4 5 6 7 8 9 10 11:CUSTom PN9 PN15 FIX4 "<file name>" EXT FDEV1_HS FDEV1_FS FDEV2_FS FACCuracy DM1 DM0 P4 P8 P16 P32 P64 [:SOURce]:RADio:DECT:PPart:SLOT0 [1] 2 3 4 5 6 7 8 9 10 11:CUSTom?
	[:SOURce]:RADio:DECT:RFPart:SLOT0 [1] 2 3 4 5 6 7 8 9 10 11:CUSTom PN9 PN15 FIX4 "<file name>" EXT FDEV1_HS FDEV1_FS FDEV2_FS FACCuracy DM1 DM0 P4 P8 P16 P32 P64 [:SOURce]:RADio:DECT:RFPart:SLOT0 [1] 2 3 4 5 6 7 8 9 10 11:CUSTom?
	[:SOURce]:RADio:EDGE :GSM:SLOT0 [1] 2 3 4 5 6 7:CUSTom PN9 PN15 FIX4 "<file name>" EXT P4 P8 P16 P32 P64 [:SOURce]:RADio:EDGE :GSM:SLOT0 [1] 2 3 4 5 6 7:CUSTom?
	[:SOURce]:RADio:PHS:DLINK:SLOT[1] 2 3 4:CUSTom PN9 PN15 FIX4 "<file name>" EXT P4 P8 P16 P32 P64 [:SOURce]:RADio:PHS:DLINK:SLOT[1] 2 3 4:CUSTom?
	[:SOURce]:RADio:PHS:ULINK:SLOT[1] 2 3 4:CUSTom PN9 PN15 FIX4 "<file name>" EXT P4 P8 P16 P32 P64 [:SOURce]:RADio:PHS:ULINK:SLOT[1] 2 3 4:CUSTom?
Configure Differential Encoding	:MEMory:DATA:FSK "<file name>," num_states,f0,f0,... [,diff_state,num_diff_states,diff0,diff1,...] :MEMory:DATA:FSK? "<file name>" :MEMory:DATA:IQ "<file name>," offsetQ,num_states,i0,q0,i1,q1,... [,diff_state,num_diff_states,diff0,diff1,...] :MEMory:DATA:IQ? "<file name>"
Configure Dn Custom Cont	[:SOURce]:RADio:TETra:SLOT[1] 2 3 4:DCCustom PN9 PN15 FIX4 "<file name>" EXT P4 P8 P16 P32 P64 [:SOURce]:RADio:TETra:SLOT[1] 2 3 4:DCCustom?
Configure Dn Custom Disc	[:SOURce]:RADio:TETra:SLOT[1] 2 3 4:DDCustom PN9 PN15 FIX4 "<file name>" EXT P4 P8 P16 P32 P64 [:SOURce]:RADio:TETra:SLOT[1] 2 3 4:DDCustom?
Configure Down Custom	[:SOURce]:RADio[:NADC]:SLOT[1] 2 3 4 5 6:DCUStom PN9 PN15 FIX4 "<file name>" EXT P4 P8 P16 P32 P64 [:SOURce]:RADio[:NADC]:SLOT[1] 2 3 4 5 6:DCUStom?
	[:SOURce]:RADio:PDC:SLOT0 [1] 2 3 4 5:DCUStom PN9 PN15 FIX4 "<file name>" EXT P4 P8 P16 P32 P64 [:SOURce]:RADio:PDC:SLOT0 [1] 2 3 4 5:DCUStom?
Configure Up Control 1	[:SOURce]:RADio:PDC:SLOT0 [1] 2 3 4 5:UC1[:DATA] PN9 PN15 FIX4 "<file name>" EXT P4 P8 P16 P32 P64 [:SOURce]:RADio:PDC:SLOT0 [1] 2 3 4 5:UC1[:DATA]?
Configure Up Control 2	[:SOURce]:RADio:PDC:SLOT0 [1] 2 3 4 5:UC2[:DATA] PN9 PN15 FIX4 "<file name>" EXT P4 P8 P16 P32 P64 [:SOURce]:RADio:PDC:SLOT0 [1] 2 3 4 5:UC2[:DATA]?

Key	SCPI Command
Configure Up Custom	[:SOURCE]:RADio:NADC:SLOT[1] 2 3 4 5 6:UCUStom PN9 PN15 FIX4 "<file name>" EXT P4 P8 P16 P32 P64 [:SOURCE]:RADio:NADC:SLOT[1] 2 3 4 5 6:UCUStom?
	[:SOURCE]:RADio:PDC:SLOT0 [1] 2 3 4 5:UCUStom PN9 PN15 FIX4 "<file name>" EXT P4 P8 P16 P32 P64 [:SOURCE]:RADio:PDC:SLOT0 [1] 2 3 4 5:UCUStom?
	[:SOURCE]:RADio:TETRa:SLOT[1] 2 3 4:UCUStom PN9 PN15 FIX4 "<file name>" EXT P4 P8 P16 P32 P64 [:SOURCE]:RADio:TETRa:SLOT[1] 2 3 4:UCUStom?
Configure Up Normal	[:SOURCE]:RADio:TETRa:SLOT[1] 2 3 4:UNORmal[:DATA] PN9 PN15 FIX4 "<file name>" EXT P4 P8 P16 P32 P64 [:SOURCE]:RADio:TETRa:SLOT[1] 2 3 4:UNORmal[:DATA]?
Copy File	[:MEMory]:COPY[:NAME] "<file name>","<file name>" [:MMEMory]:COPY "<file name>","<file name>"
CSID	[:SOURCE]:RADio:PHS:DLINK:SLOT[1] 2 3 4:SCHannel:CSID <bit pattern> [:SOURCE]:RADio:PHS:DLINK:SLOT[1] 2 3 4:SCHannel:CSID? [:SOURCE]:RADio:PHS:ULINK:SLOT[1] 2 3 4:SCHannel:CSID <bit pattern> [:SOURCE]:RADio:PHS:ULINK:SLOT[1] 2 3 4:SCHannel:CSID?
Custom	[:SOURCE]:RADio:DECT:PPart:SLOT0 [1] 2 3 4 5 6 7 8 9 10 11 [:TYPE] CUSTom [:SOURCE]:RADio:DECT:PPart:SLOT0 [1] 2 3 4 5 6 7 8 9 10 11[:TYPE]?
	[:SOURCE]:RADio:DECT:RFPart:SLOT0 [1] 2 3 4 5 6 7 8 9 10 11 [:TYPE] CUSTom [:SOURCE]:RADio:DECT:RFPart:SLOT0 [1] 2 3 4 5 6 7 8 9 10 11[:TYPE]?
	[:SOURCE]:RADio:EDGE GSM:SLOT0 [1] 2 3 4 5 6 7[:TYPE] CUSTom [:SOURCE]:RADio:EDGE GSM:SLOT0 [1] 2 3 4 5 6 7[:TYPE]?
	[:SOURCE]:RADio:PHS:DLINK:SLOT[1] 2 3 4[:TYPE] CUSTom [:SOURCE]:RADio:PHS:DLINK:SLOT[1] 2 3 4[:TYPE]? [:SOURCE]:RADio:PHS:ULINK:SLOT[1] 2 3 4[:TYPE] CUSTom [:SOURCE]:RADio:PHS:ULINK:SLOT[1] 2 3 4[:TYPE]?
Custom Off On	[:SOURCE]:RADio:CUSTom[:STATe] ON OFF 1 0 [:SOURCE]:RADio:CUSTom[:STATe]?
Custom TS	[:SOURCE]:RADio:EDGE:SLOT0 [1] 2 3 4 5 6 7:NORMal:TSEquence TSCO TSC1 TSC2 TSC3 TSC4 TSC5 TSC6 TSC7 <78-bit pattern> [:SOURCE]:RADio:EDGE:SLOT0 [1] 2 3 4 5 6 7:NORMal:TSEquence?
D8PSK	[:SOURCE]:RADio:CUSTom:MODulation[:TYPE] D8PSK [:SOURCE]:RADio:CUSTom:MODulation[:TYPE]?
	[:SOURCE]:RADio:<desired format>:MODulation[:TYPE] D8PSK [:SOURCE]:RADio:<desired format>:MODulation[:TYPE]?

Key	SCPI Command
Data	[:SOURCE]:RADio:CUSTom DECT GSM [:NADC] PDC PHS TETRA:DATA PN9 PN11 PN15 PN20 PN23 FIX4 "<file name>" EXT P4 P8 P16 P32 P64 [:SOURCE]:RADio:CUSTom DECT GSM [:NADC] PDC PHS TETRA:DATA?
	[:SOURCE]:RADio:EDGE:DATA PN9 PN15 FIX4 "<file name>" EXT P4 P8 P16 P32 P64 [:SOURCE]:RADio:<EDGE>:DATA?
	[:SOURCE]:RADio:EDGE :GSM:SLOT0 [1] 2 3 4 5 6 7:CUSTom PN9 PN15 FIX4 "<file name>" EXT P4 P8 P16 P32 P64 [:SOURCE]:RADio:EDGE :GSM:SLOT0 [1] 2 3 4 5 6 7:CUSTom?
	[:SOURCE]:RADio[:NADC]:SLOT[1] 2 3 4 5 6:DCUStom PN9 PN15 FIX4 "<file name>" EXT P4 P8 P16 P32 P64 [:SOURCE]:RADio[:NADC]:SLOT[1] 2 3 4 5 6:DCUStom? [:SOURCE]:RADio[:NADC]:SLOT[1] 2 3 4 5 6:DTCHannel[:DATA] PN9 PN15 FIX4 "<file name>" EXT P4 P8 P16 P32 P64 [:SOURCE]:RADio[:NADC]:SLOT[1] 2 3 4 5 6:DTCHannel[:DATA]? [:SOURCE]:RADio[:NADC]:SLOT[1] 2 3 4 5 6:UCUStom PN9 PN15 FIX4 "<file name>" EXT P4 P8 P16 P32 P64 [:SOURCE]:RADio[:NADC]:SLOT[1] 2 3 4 5 6:UCUStom? [:SOURCE]:RADio[:NADC]:SLOT[1] 2 3 4 5 6:UTCHannel[:DATA] PN9 PN15 FIX4 "<file name>" EXT P4 P8 P16 P32 P64 [:SOURCE]:RADio[:NADC]:SLOT[1] 2 3 4 5 6:UTCHannel[:DATA]?

Key	SCPI Command
Data continued	<pre>[:SOURce]:RADio:PDC:SLOT0 [1] 2 3 4 5:DCUStom PN9 PN15 FIX4 "<file name>" EXT P4 P8 P16 P32 P64 [:SOURce]:RADio:PDC:SLOT0 [1] 2 3 4 5:DCUStom? [:SOURce]:RADio:PDC:SLOT0 [1] 2 3 4 5:UCUStom PN9 PN15 FIX4 "<file name>" EXT P4 P8 P16 P32 P64 [:SOURce]:RADio:PDC:SLOT0 [1] 2 3 4 5:UCUStom?</pre>
	<pre>[:SOURce]:RADio:PHS:DLINk:SLOT[1] 2 3 4:CUSTom PN9 PN15 FIX4 "<file name>" EXT P4 P8 P16 P32 P64 [:SOURce]:RADio:PHS:DLINk:SLOT[1] 2 3 4:CUSTom? [:SOURce]:RADio:PHS:ULINk:SLOT[1] 2 3 4:CUSTom PN9 PN15 FIX4 "<file name>" EXT P4 P8 P16 P32 P64 [:SOURce]:RADio:PHS:ULINk:SLOT[1] 2 3 4:CUSTom? [:SOURce]:RADio:PHS:DLINk:SLOT[1] 2 3 4:TCHannel[:TCHannel] PN9 PN15 FIX4 "<file name>" EXT P4 P8 P16 P32 P64 [:SOURce]:RADio:PHS:DLINk:SLOT[1] 2 3 4:TCHannel[:TCHannel]? [:SOURce]:RADio:PHS:ULINk:SLOT[1] 2 3 4:TCHannel[:TCHannel] PN9 PN15 FIX4 "<file name>" EXT P4 P8 P16 P32 P64 [:SOURce]:RADio:PHS:ULINk:SLOT[1] 2 3 4:TCHannel[:TCHannel]?</pre>
	<pre>[:SOURce]:RADio:TETRA:SLOT[1] 2 3 4:DCNormal[:DATA] PN9 PN15 FIX4 "<file name>" EXT P4 P8 P16 P32 P64 [:SOURce]:RADio:TETRA:SLOT[1] 2 3 4:DCNormal[:DATA]? [:SOURce]:RADio:TETRA:SLOT[1] 2 3 4:DCSync[:DATA] PN9 PN15 FIX4 "<file name>" EXT P4 P8 P16 P32 P64 [:SOURce]:RADio:TETRA:SLOT[1] 2 3 4:DCSync[:DATA]? [:SOURce]:RADio:TETRA:SLOT[1] 2 3 4:DDNormal[:DATA] PN9 PN15 FIX4 "<file name>" EXT P4 P8 P16 P32 P64 [:SOURce]:RADio:TETRA:SLOT[1] 2 3 4:DDNormal[:DATA]? [:SOURce]:RADio:TETRA:SLOT[1] 2 3 4:DDSync[:DATA] PN9 PN15 FIX4 "<file name>" EXT P4 P8 P16 P32 P64 [:SOURce]:RADio:TETRA:SLOT[1] 2 3 4:DDSync[:DATA]? [:SOURce]:RADio:TETRA:SLOT[1] 2 3 4:UC1[:DATA] PN9 PN15 FIX4 "<file name>" EXT P4 P8 P16 P32 P64 [:SOURce]:RADio:TETRA:SLOT[1] 2 3 4:UC1[:DATA]? [:SOURce]:RADio:TETRA:SLOT[1] 2 3 4:UC2[:DATA] PN9 PN15 FIX4 "<file name>" EXT P4 P8 P16 P32 P64 [:SOURce]:RADio:TETRA:SLOT[1] 2 3 4:UC2[:DATA]? [:SOURce]:RADio:TETRA:SLOT[1] 2 3 4:UNORmal[:DATA] PN9 PN15 FIX4 "<file name>" EXT P4 P8 P16 P32 P64 [:SOURce]:RADio:TETRA:SLOT[1] 2 3 4:UNORmal[:DATA]?</pre>
Data Format Pattern Framed	<pre>[:SOURce]:RADio:<desired format>:BURSt[:STATe] ON OFF 1 0 [:SOURce]:RADio:<desired format>:BURSt[:STATe]?</pre>
DCS Base	<pre>[:SOURce]:RADio:EDGE GSM:FCHannel:BAND BDCS [:SOURce]:RADio:EDGE GSM:FCHannel:BAND?</pre>
DCS Mobile	<pre>[:SOURce]:RADio:EDGE GSM:FCHannel:BAND MDCS [:SOURce]:RADio:EDGE GSM:FCHannel:BAND?</pre>

Key	SCPI Command
DECT Off On	[:SOURce]:RADio:DECT[:STATE] ON OFF 1 0 [:SOURce]:RADio:DECT[:STATE]?
Define User FIR	:MEMory:DATA:FIR "<file name>",<osr>,<coefficient>{,<coefficient>} :MEMory:DATA:FIR? "<file name>"
Define User FSK	:MEMory:DATA:FSK "<file name>",<num_states>,<f0>,<f0>,... [,<diff_state>,<num_diff_states>,<diff0>,<diff1>,...] :MEMory:DATA:FSK? "<file name>"
Define User I/Q	:MEMory:DATA:IQ "<file name>",<offsetQ>,<num_states>,<i0>,<q0>,<i1>,<q1>,... [,<diff_state>,<num_diff_states>,<diff0>,<diff1>,...] :MEMory:DATA:IQ? "<file name>"
Diff Data Encode Off On	[:SOURce]:RADio:CUSTom:DENCode ON OFF 1 0 [:SOURce]:RADio:CUSTom:DENCode? [:SOURce]:RADio:GSM:DENCode ON OFF 1 0 [:SOURce]:RADio:GSM:DENCode?
Differential Encoding Off On	:MEMory:DATA:FSK "<file name>",<num_states>,<f0>,<f1>,... [,<diff_state>,<num_diff_states>,<diff0>,<diff1>,...] :MEMory:DATA:IQ "<file name>",<offsetQ>,<num_states>,<i0>,<q0>,<i1>,<q1>,... [,<diff_state>,<num_diff_states>,<diff0>,<diff1>,...]
DMO	[:SOURce]:RADio:DECT:PPart:SLOT0 [1] 2 3 4 5 6 7 8 9 10 11:CUSTom DMO [:SOURce]:RADio:DECT:PPart:SLOT0 [1] 2 3 4 5 6 7 8 9 10 11:CUSTom? [:SOURce]:RADio:DECT:PPart:SLOT0 [1] 2 3 4 5 6 7 8 9 10 11:LCAPacity [:B] DMO [:SOURce]:RADio:DECT:PPart:SLOT0 [1] 2 3 4 5 6 7 8 9 10 11:LCAPacity[:B]? [:SOURce]:RADio:DECT:PPart:SLOT0 [1] 2 3 4 5 6 7 8 9 10 11:TRAFFic[:B] DMO [:SOURce]:RADio:DECT:PPart:SLOT0 [1] 2 3 4 5 6 7 8 9 10 11:TRAFFic[:B]? [:SOURce]:RADio:DECT:PPart:SLOT0 [1] 2 3 4 5 6 7 8 9 10 11:ZLCapacity [:B] DMO [:SOURce]:RADio:DECT:PPart:SLOT0 [1] 2 3 4 5 6 7 8 9 10 11:ZLCapacity[:B]? [:SOURce]:RADio:DECT:PPart:SLOT0 [1] 2 3 4 5 6 7 8 9 10 11:ZTRAFFic[:B] DMO [:SOURce]:RADio:DECT:PPart:SLOT0 [1] 2 3 4 5 6 7 8 9 10 11:ZTRAFFic[:B]? [:SOURce]:RADio:DECT:RFPart:SLOT0 [1] 2 3 4 5 6 7 8 9 10 11:CUSTom DMO [:SOURce]:RADio:DECT:RFPart:SLOT0 [1] 2 3 4 5 6 7 8 9 10 11:CUSTom? [:SOURce]:RADio:DECT:RFPart:SLOT0 [1] 2 3 4 5 6 7 8 9 10 11:LCAPacity [:B] DMO [:SOURce]:RADio:DECT:RFPart:SLOT0 [1] 2 3 4 5 6 7 8 9 10 11:LCAPacity[:B]? [:SOURce]:RADio:DECT:RFPart:SLOT0 [1] 2 3 4 5 6 7 8 9 10 11:TRAFFic[:B] DMO [:SOURce]:RADio:DECT:RFPart:SLOT0 [1] 2 3 4 5 6 7 8 9 10 11:TRAFFic[:B]? [:SOURce]:RADio:DECT:RFPart:SLOT0 [1] 2 3 4 5 6 7 8 9 10 11:ZLCapacity [:B] DMO [:SOURce]:RADio:DECT:RFPart:SLOT0 [1] 2 3 4 5 6 7 8 9 10 11:ZLCapacity[:B]? [:SOURce]:RADio:DECT:RFPart:SLOT0 [1] 2 3 4 5 6 7 8 9 10 11:ZTRAFFic[:B] DMO [:SOURce]:RADio:DECT:RFPart:SLOT0 [1] 2 3 4 5 6 7 8 9 10 11:ZTRAFFic[:B]?

Key	SCPI Command
DM1	<pre>[:SOURCE]:RADIO:DECT:PPart:SLOT0 [1] 2 3 4 5 6 7 8 9 10 11:CUSTOM DM1 [:SOURCE]:RADIO:DECT:PPart:SLOT0 [1] 2 3 4 5 6 7 8 9 10 11:CUSTOM? [:SOURCE]:RADIO:DECT:PPart:SLOT0 [1] 2 3 4 5 6 7 8 9 10 11:LCAPACITY[:B] DM1 [:SOURCE]:RADIO:DECT:PPart:SLOT0 [1] 2 3 4 5 6 7 8 9 10 11:LCAPACITY[:B]? [:SOURCE]:RADIO:DECT:PPart:SLOT0 [1] 2 3 4 5 6 7 8 9 10 11:TRAFFIC[:B] DM1 [:SOURCE]:RADIO:DECT:PPart:SLOT0 [1] 2 3 4 5 6 7 8 9 10 11:TRAFFIC[:B]? [:SOURCE]:RADIO:DECT:PPart:SLOT0 [1] 2 3 4 5 6 7 8 9 10 11:ZLCAPACITY [:B] DM1 [:SOURCE]:RADIO:DECT:PPart:SLOT0 [1] 2 3 4 5 6 7 8 9 10 11:ZLCAPACITY[:B]? [:SOURCE]:RADIO:DECT:PPart:SLOT0 [1] 2 3 4 5 6 7 8 9 10 11:ZTRAFFIC[:B] DM1 [:SOURCE]:RADIO:DECT:PPart:SLOT0 [1] 2 3 4 5 6 7 8 9 10 11:ZTRAFFIC[:B]? [:SOURCE]:RADIO:DECT:RFPART:SLOT0 [1] 2 3 4 5 6 7 8 9 10 11:CUSTOM DM1 [:SOURCE]:RADIO:DECT:RFPART:SLOT0 [1] 2 3 4 5 6 7 8 9 10 11:CUSTOM? [:SOURCE]:RADIO:DECT:RFPART:SLOT0 [1] 2 3 4 5 6 7 8 9 10 11:LCAPACITY [:B] DM1 [:SOURCE]:RADIO:DECT:RFPART:SLOT0 [1] 2 3 4 5 6 7 8 9 10 11:LCAPACITY[:B]? [:SOURCE]:RADIO:DECT:RFPART:SLOT0 [1] 2 3 4 5 6 7 8 9 10 11:TRAFFIC[:B] DM1 [:SOURCE]:RADIO:DECT:RFPART:SLOT0 [1] 2 3 4 5 6 7 8 9 10 11:TRAFFIC[:B]? [:SOURCE]:RADIO:DECT:RFPART:SLOT0 [1] 2 3 4 5 6 7 8 9 10 11:ZLCAPACITY [:B] DM1 [:SOURCE]:RADIO:DECT:RFPART:SLOT0 [1] 2 3 4 5 6 7 8 9 10 11:ZLCAPACITY[:B]? [:SOURCE]:RADIO:DECT:RFPART:SLOT0 [1] 2 3 4 5 6 7 8 9 10 11:ZTRAFFIC[:B] DM1 [:SOURCE]:RADIO:DECT:RFPART:SLOT0 [1] 2 3 4 5 6 7 8 9 10 11:ZTRAFFIC[:B]?</pre>
Dn Custom Cont	<pre>[:SOURCE]:RADIO:TETRA:SLOT[1] 2 3 4[:TYPE] DCCustom [:SOURCE]:RADIO:TETRA:SLOT[1] 2 3 4[:TYPE]?</pre>
Dn Custom Disc	<pre>[:SOURCE]:RADIO:TETRA:SLOT[1] 2 3 4[:TYPE] DDCustom [:SOURCE]:RADIO:TETRA:SLOT[1] 2 3 4[:TYPE]?</pre>
Dn Normal Cont	<pre>[:SOURCE]:RADIO:TETRA:SLOT[1] 2 3 4[:TYPE] DCNormal [:SOURCE]:RADIO:TETRA:SLOT[1] 2 3 4[:TYPE]?</pre>
Dn Normal Disc	<pre>[:SOURCE]:RADIO:TETRA:SLOT[1] 2 3 4[:TYPE] DDNormal [:SOURCE]:RADIO:TETRA:SLOT[1] 2 3 4[:TYPE]?</pre>
Dn Sync Cont	<pre>[:SOURCE]:RADIO:TETRA:SLOT[1] 2 3 4[:TYPE] DCSync [:SOURCE]:RADIO:TETRA:SLOT[1] 2 3 4[:TYPE]?</pre>
Dn Sync Disc	<pre>[:SOURCE]:RADIO:TETRA:SLOT[1] 2 3 4[:TYPE] DDSync [:SOURCE]:RADIO:TETRA:SLOT[1] 2 3 4[:TYPE]?</pre>
Down Custom	<pre>[:SOURCE]:RADIO:PDC:SLOT0 [1] 2 3 4 5[:TYPE] DCUStom [:SOURCE]:RADIO:PDC:SLOT0 [1] 2 3 4 5[:TYPE]?</pre>
	<pre>[:SOURCE]:RADIO[:NADC]:SLOT[1] 2 3 4 5 6[:TYPE] DCUStom [:SOURCE]:RADIO[:NADC]:SLOT[1] 2 3 4 5 6[:TYPE]?</pre>
Down TCH	<pre>[:SOURCE]:RADIO:PDC:SLOT0 [1] 2 3 4 5[:TYPE] DTCH [:SOURCE]:RADIO:PDC:SLOT0 [1] 2 3 4 5[:TYPE]?</pre>
	<pre>[:SOURCE]:RADIO[:NADC]:SLOT[1] 2 3 4 5 6[:TYPE] DTCH [:SOURCE]:RADIO[:NADC]:SLOT[1] 2 3 4 5 6[:TYPE]?</pre>

Key	SCPI Command
Down TCH All	[:SOURCE] :RADio:PDC:SLOT0 [1] 2 3 4 5 [:TYPE] DTCH_ALL [:SOURCE] :RADio:PDC:SLOT0 [1] 2 3 4 5 [:TYPE] ?
	[:SOURCE] :RADio[:NADC]:SLOT[1] 2 3 4 5 6 [:TYPE] DTCH_ALL [:SOURCE] :RADio[:NADC]:SLOT[1] 2 3 4 5 6 [:TYPE] ?
Downlink MCS-1	[:SOURCE] :RADio:GSM:SLOT0 [1] 2 3 4 5 6 7 :NORMAL : ENCryption DMCS1 [:SOURCE] :RADio:GSM:SLOT0 [1] 2 3 4 5 6 7 :NORMAL :ENCryption?
Downlink MCS-5	[:SOURCE] :RADio:EDGE:SLOT0 [1] 2 3 4 5 6 7 :NORMAL :ENCryption:DLINK:MCS9 :DATA PN9 PN15 [:SOURCE] :RADio:EDGE:SLOT0 [1] 2 3 4 5 6 7 :NORMAL :ENCryption:DLINK:MCS9 :DATA?
Downlink MCS-9	[:SOURCE] :RADio:EDGE:SLOT0 [1] 2 3 4 5 6 7 :NORMAL :ENCryption:DLINK:MCS9 :DATA PN9 PN15 [:SOURCE] :RADio:EDGE:SLOT0 [1] 2 3 4 5 6 7 :NORMAL :ENCryption:DLINK:MCS9 :DATA?
Dummy	[:SOURCE] :RADio:GSM:SLOT0 [1] 2 3 4 5 6 7 [:TYPE] DUMMy [:SOURCE] :RADio:GSM:SLOT0 [1] 2 3 4 5 6 7 [:TYPE] ?
Dummy Bearer 1	[:SOURCE] :RADio:DECT:RFPart:SLOT0 [1] 2 3 4 5 6 7 8 9 10 11 [:TYPE] DUMM[1] [:SOURCE] :RADio:DECT:RFPart:SLOT0 [1] 2 3 4 5 6 7 8 9 10 11 [:TYPE]
Dummy Bearer 2	[:SOURCE] :RADio:DECT:RFPart:SLOT0 [1] 2 3 4 5 6 7 8 9 10 11 [:TYPE] DUMM2 [:SOURCE] :RADio:DECT:RFPart:SLOT0 [1] 2 3 4 5 6 7 8 9 10 11 [:TYPE] ?
E	[:SOURCE] :RADio:EDGE:SLOT0 [1] 2 3 4 5 6 7 :NORMAL :ENCryption PN9 PN15 FIX4 "<file name>" EXT P4 P8 P16 P32 P64 [:SOURCE] :RADio:EDGE:SLOT0 [1] 2 3 4 5 6 7 :NORMAL :ENCryption?
	[:SOURCE] :RADio:GSM:SLOT0 [1] 2 3 4 5 6 7 :ACCEss:ENCryption PN9 PN15 FIX4 "<file name>" EXT P4 P8 P16 P32 P64 [:SOURCE] :RADio:GSM:SLOT0 [1] 2 3 4 5 6 7 :ACCEss:ENCryption?
	[:SOURCE] :RADio:GSM:SLOT0 [1] 2 3 4 5 6 7 :NORMAL :ENCryption PN9 PN15 FIX4 "<file name>" EXT P4 P8 P16 P32 P64 [:SOURCE] :RADio:GSM:SLOT0 [1] 2 3 4 5 6 7 :NORMAL :ENCryption?
	[:SOURCE] :RADio:GSM:SLOT0 [1] 2 3 4 5 6 7 :SYNC:ENCryption PN9 PN15 FIX4 "<file name>" EXT P4 P8 P16 P32 P64 [:SOURCE] :RADio:GSM:SLOT0 [1] 2 3 4 5 6 7 :SYNC:ENCryption?
E Field Data	[:SOURCE] :RADio:EDGE:BNCMux:DOut EDATa [:SOURCE] :RADio:EDGE:BNCMux:DOut?
E-GSM Base	[:SOURCE] :RADio:EDGE GSM:FCHannel:BAND BEGSm [:SOURCE] :RADio:EDGE GSM:FCHannel:BAND?
E-GSM Mobile	[:SOURCE] :RADio:EDGE GSM:FCHannel:BAND MEGSm [:SOURCE] :RADio:EDGE GSM:FCHannel:BAND?

Key	SCPI Command
E-TCH/F43.2	[:SOURCE]:RADIO:EDGE:SLOT0 [1] 2 3 4 5 6 7:NORMAL:ENCRYPTION:ETCH: F43:DATA PN9 PN15 [:SOURCE]:RADIO:EDGE:SLOT0 [1] 2 3 4 5 6 7:NORMAL:ENCRYPTION:ETCH: F43:DATA?
EDGE	[:SOURCE]:RADIO:EDGE:FILTER EDGE [:SOURCE]:RADIO:EDGE:FILTER EDGE? [:SOURCE]:RADIO:EDGE:MODULATION[:TYPE] EDGE [:SOURCE]:RADIO:EDGE:MODULATION[:TYPE]?
EDGE Off On	[:SOURCE]:RADIO:EDGE[:STATE] ON OFF 1 0 [:SOURCE]:RADIO:EDGE[:STATE]?
ET	[:SOURCE]:RADIO:GSM:SLOT0 [1] 2 3 4 5 6 7:ACCESS:ETAIL <bit pattern> [:SOURCE]:RADIO:GSM:SLOT0 [1] 2 3 4 5 6 7:ACCESS:ETAIL?
Event 1	[:SOURCE]:RADIO:EDGE:BNCMUX:EVENT MTRIGGER FTRIGGER [:SOURCE]:RADIO:EDGE:BNCMUX:EVENT?

Key	SCPI Command
EXT	<pre>[:SOURce]:RADio:CUSTom:DATA EXT [:SOURce]:RADio:CUSTom:DATA? [:SOURce]:RADio:CUSTom:TRIGger[:SOURce] EXT [:SOURce]:RADio:CUSTom:TRIGger[:SOURce]? [:SOURce]:RADio:<desired format>:DATA EXT [:SOURce]:RADio:<desired format>:DATA? [:SOURce]:RADio:<desired format>:TRIGger[:SOURce] EXT [:SOURce]:RADio:<desired format>:TRIGger[:SOURce]? [:SOURce]:RADio:<desired format>:TRIGger[:SOURce]:EXTernal[:TYPE] SINGLE GATE RESet MANual [:SOURce]:RADio:<desired format>:TRIGger[:SOURce]:EXTernal[:TYPE]? [:SOURce]:RADio:<desired format>:SECondary:TRIGger[:SOURce] EXT [:SOURce]:RADio:<desired format>:SECondary:TRIGger[:SOURce]?</pre>
	<pre>[:SOURce]:RADio:DECT:PPart:SLOT0 [1] 2 3 4 5 6 7 8 9 10 11:CUSTom EXT [:SOURce]:RADio:DECT:PPart:SLOT0 [1] 2 3 4 5 6 7 8 9 10 11:CUSTom? [:SOURce]:RADio:DECT:PPart:SLOT0 [1] 2 3 4 5 6 7 8 9 10 11:LCAPacity [:B] EXT [:SOURce]:RADio:DECT:PPart:SLOT0 [1] 2 3 4 5 6 7 8 9 10 11:LCAPacity[:B]? [:SOURce]:RADio:DECT:PPart:SLOT0 [1] 2 3 4 5 6 7 8 9 10 11:TRAFfic[:B] EXT [:SOURce]:RADio:DECT:PPart:SLOT0 [1] 2 3 4 5 6 7 8 9 10 11:TRAFfic[:B]? [:SOURce]:RADio:DECT:PPart:SLOT0 [1] 2 3 4 5 6 7 8 9 10 11:ZLCapacity [:B] EXT [:SOURce]:RADio:DECT:PPart:SLOT0 [1] 2 3 4 5 6 7 8 9 10 11:ZLCapacity[:B]? [:SOURce]:RADio:DECT:PPart:SLOT0 [1] 2 3 4 5 6 7 8 9 10 11:ZTRAffic[:B] EXT [:SOURce]:RADio:DECT:PPart:SLOT0 [1] 2 3 4 5 6 7 8 9 10 11:ZTTRAffic[:B]? [:SOURce]:RADio:DECT:RFPart:SLOT0 [1] 2 3 4 5 6 7 8 9 10 11:CUSTom EXT [:SOURce]:RADio:DECT:RFPart:SLOT0 [1] 2 3 4 5 6 7 8 9 10 11:CUSTom? [:SOURce]:RADio:DECT:RFPart:SLOT0 [1] 2 3 4 5 6 7 8 9 10 11:LCAPacity [:B] EXT [:SOURce]:RADio:DECT:RFPart:SLOT0 [1] 2 3 4 5 6 7 8 9 10 11:LCAPacity[:B]? [:SOURce]:RADio:DECT:RFPart:SLOT0 [1] 2 3 4 5 6 7 8 9 10 11:TRAFfic[:B] EXT [:SOURce]:RADio:DECT:RFPart:SLOT0 [1] 2 3 4 5 6 7 8 9 10 11:TRAFfic[:B]? [:SOURce]:RADio:DECT:RFPart:SLOT0 [1] 2 3 4 5 6 7 8 9 10 11:ZLCapacity [:B] EXT [:SOURce]:RADio:DECT:RFPart:SLOT0 [1] 2 3 4 5 6 7 8 9 10 11:ZLCapacity[:B]? [:SOURce]:RADio:DECT:RFPart:SLOT0 [1] 2 3 4 5 6 7 8 9 10 11:ZTRAffic[:B] EXT [:SOURce]:RADio:DECT:RFPart:SLOT0 [1] 2 3 4 5 6 7 8 9 10 11:ZTTRAffic[:B]?</pre>
	<pre>[:SOURce]:RADio:EDGE:SLOT0 [1] 2 3 4 5 6 7:CUSTom EXT [:SOURce]:RADio:EDGE:SLOT0 [1] 2 3 4 5 6 7:CUSTom? [:SOURce]:RADio:EDGE:SLOT0 [1] 2 3 4 5 6 7:NORMal:ENCRyption EXT [:SOURce]:RADio:EDGE:SLOT0 [1] 2 3 4 5 6 7:NORMal:ENCRyption?</pre>

Key	SCPI Command
EXT continued	<pre>[:SOURce]:RADio:GSM:SLOT0 [1] 2 3 4 5 6 7:ACCess:ENCRyption EXT [:SOURce]:RADio:GSM:SLOT0 [1] 2 3 4 5 6 7:ACCess:ENCRyption? [:SOURce]:RADio:GSM:SLOT0 [1] 2 3 4 5 6 7:CUSTom EXT [:SOURce]:RADio:GSM:SLOT0 [1] 2 3 4 5 6 7:CUSTom? [:SOURce]:RADio:GSM:SLOT0 [1] 2 3 4 5 6 7:NORMal:ENCRyption EXT [:SOURce]:RADio:GSM:SLOT0 [1] 2 3 4 5 6 7:NORMal:ENCRyption? [:SOURce]:RADio:GSM:SLOT0 [1] 2 3 4 5 6 7:SYNC:ENCRyption EXT [:SOURce]:RADio:GSM:SLOT0 [1] 2 3 4 5 6 7:SYNC:ENCRyption?</pre>
	<pre>[:SOURce]:RADio[:NADC]:SLOT[1] 2 3 4 5 6:DCUStom EXT [:SOURce]:RADio[:NADC]:SLOT[1] 2 3 4 5 6:DCUStom? [:SOURce]:RADio[:NADC]:SLOT[1] 2 3 4 5 6:DTCHannel[:DATA] EXT [:SOURce]:RADio[:NADC]:SLOT[1] 2 3 4 5 6:DTCHannel[:DATA]? [:SOURce]:RADio[:NADC]:SLOT[1] 2 3 4 5 6:UCUStom EXT [:SOURce]:RADio[:NADC]:SLOT[1] 2 3 4 5 6:UCUStom? [:SOURce]:RADio[:NADC]:SLOT[1] 2 3 4 5 6:UTCHannel[:DATA] EXT [:SOURce]:RADio[:NADC]:SLOT[1] 2 3 4 5 6:UTCHannel[:DATA]?</pre>
	<pre>[:SOURce]:RADio:PDC:SLOT0 [1] 2 3 4 5:DCUStom EXT [:SOURce]:RADio:PDC:SLOT0 [1] 2 3 4 5:DCUStom? [:SOURce]:RADio:PDC:SLOT0 [1] 2 3 4 5:DTCHannel[:TCHannel] EXT [:SOURce]:RADio:PDC:SLOT0 [1] 2 3 4 5:DTCHannel[:TCHannel]? [:SOURce]:RADio:PDC:SLOT0 [1] 2 3 4 5:UCUStom EXT [:SOURce]:RADio:PDC:SLOT0 [1] 2 3 4 5:UCUStom? [:SOURce]:RADio:PDC:SLOT0 [1] 2 3 4 5:UTCHannel[:TCHannel] EXT [:SOURce]:RADio:PDC:SLOT0 [1] 2 3 4 5:UTCHannel[:TCHannel]?</pre>
	<pre>[:SOURce]:RADio:PHS:DLINK:SLOT[1] 2 3 4:CUSTom EXT [:SOURce]:RADio:PHS:DLINK:SLOT[1] 2 3 4:CUSTom? [:SOURce]:RADio:PHS:DLINK:SLOT[1] 2 3 4:TCHannel[:TCHannel] EXT [:SOURce]:RADio:PHS:DLINK:SLOT[1] 2 3 4:TCHannel[:TCHannel]? [:SOURce]:RADio:PHS:ULINK:SLOT[1] 2 3 4:CUSTom EXT [:SOURce]:RADio:PHS:ULINK:SLOT[1] 2 3 4:CUSTom? [:SOURce]:RADio:PHS:ULINK:SLOT[1] 2 3 4:TCHannel[:TCHannel] EXT [:SOURce]:RADio:PHS:ULINK:SLOT[1] 2 3 4:TCHannel[:TCHannel]?</pre>

Key	SCPI Command
EXT continued	[:SOURce] : RADio : TETra : SLoT [1] 2 3 4 : DCcUstom EXT [:SOURce] : RADio : TETra : SLoT [1] 2 3 4 : DCcUstom ?
	[:SOURce] : RADio : TETra : SLoT [1] 2 3 4 : DCNormal [: DATA] EXT [:SOURce] : RADio : TETra : SLoT [1] 2 3 4 : DCNormal [: DATA] ?
	[:SOURce] : RADio : TETra : SLoT [1] 2 3 4 : DCsync [: DATA] EXT [:SOURce] : RADio : TETra : SLoT [1] 2 3 4 : DCsync [: DATA] ?
	[:SOURce] : RADio : TETra : SLoT [1] 2 3 4 : DDcUstom [: DATA] EXT [:SOURce] : RADio : TETra : SLoT [1] 2 3 4 : DDcUstom [: DATA] ?
	[:SOURce] : RADio : TETra : SLoT [1] 2 3 4 : DDNormal [: DATA] EXT [:SOURce] : RADio : TETra : SLoT [1] 2 3 4 : DDNormal [: DATA] ?
	[:SOURce] : RADio : TETra : SLoT [1] 2 3 4 : DDSync [: DATA] EXT [:SOURce] : RADio : TETra : SLoT [1] 2 3 4 : DDSync [: DATA] ?
	[:SOURce] : RADio : TETra : SLoT [1] 2 3 4 : UC1 [: DATA] EXT [:SOURce] : RADio : TETra : SLoT [1] 2 3 4 : UC1 [: DATA] ?
	[:SOURce] : RADio : TETra : SLoT [1] 2 3 4 : UC2 [: DATA] EXT [:SOURce] : RADio : TETra : SLoT [1] 2 3 4 : UC2 [: DATA] ?
	[:SOURce] : RADio : TETra : SLoT [1] 2 3 4 : UCcUstom EXT [:SOURce] : RADio : TETra : SLoT [1] 2 3 4 : UCcUstom ?
	[:SOURce] : RADio : TETra : SLoT [1] 2 3 4 : UNormal [: DATA] EXT [:SOURce] : RADio : TETra : SLoT [1] 2 3 4 : UNormal [: DATA] ?
Ext Data Clock Normal Symbol	[:SOURce] : RADio : CUSTom : EDCLock SYMBol NORMal [:SOURce] : RADio : CUSTom : EDCLock ?
	[:SOURce] : RADio : <desired format> : EDCLock SYMBol NORMal [:SOURce] : RADio : <desired format> : EDCLock ?
Ext Delay Bits	[:SOURce] : RADio : CUSTom : TRIGger [:SOURce] : EXTErnal : DELay <value> [:SOURce] : RADio : CUSTom : TRIGger [:SOURce] : EXTErnal : DELay ?
	[:SOURce] : RADio : <desired format> : TRIGger [:SOURce] : EXTErnal : DELay <value> [:SOURce] : RADio : <desired format> : TRIGger [:SOURce] : EXTErnal : DELay ?
Ext Delay Off On	[:SOURce] : RADio : CUSTom : TRIGger [:SOURce] : EXTErnal : DELay : STATE ON OFF 1 0 [:SOURce] : RADio : CUSTom : TRIGger [:SOURce] : EXTErnal : DELay : STATE ?
	[:SOURce] : RADio : <desired format> : TRIGger [:SOURce] : EXTErnal : DELay : STATE ON OFF 1 0 [:SOURce] : RADio : <desired format> : TRIGger [:SOURce] : EXTErnal : DELay : STATE ?
External 13 MHz Off On	[:SOURce] : RADio : EDGE GSM : EREFEreNce ON OFF 1 0 [:SOURce] : RADio : EDGE GSM : EREFEreNce ?

Key	SCPI Command
FACC	<pre>[:SOURCE]:RADIO:DECT:PPart:SLOT0 [1] 2 3 4 5 6 7 8 9 10 11:CUSTOM FACCuracy [:SOURCE]:RADIO:DECT:PPart:SLOT0 [1] 2 3 4 5 6 7 8 9 10 11:CUSTOM? [:SOURCE]:RADIO:DECT:PPart:SLOT0 [1] 2 3 4 5 6 7 8 9 10 11:LCAPacity [:B] FACCuracy [:SOURCE]:RADIO:DECT:PPart:SLOT0 [1] 2 3 4 5 6 7 8 9 10 11:LCAPacity[:B]? [:SOURCE]:RADIO:DECT:PPart:SLOT0 [1] 2 3 4 5 6 7 8 9 10 11:TRAFFic [:B] FACCuracy [:SOURCE]:RADIO:DECT:PPart:SLOT0 [1] 2 3 4 5 6 7 8 9 10 11:TRAFFic[:B]? [:SOURCE]:RADIO:DECT:PPart:SLOT0 [1] 2 3 4 5 6 7 8 9 10 11:ZLCapacity [:B] FACCuracy [:SOURCE]:RADIO:DECT:PPart:SLOT0 [1] 2 3 4 5 6 7 8 9 10 11:ZLCapacity[:B]? [:SOURCE]:RADIO:DECT:PPart:SLOT0 [1] 2 3 4 5 6 7 8 9 10 11:ZTRAFFic [:B] FACCuracy [:SOURCE]:RADIO:DECT:PPart:SLOT0 [1] 2 3 4 5 6 7 8 9 10 11:ZTRAFFic[:B]?</pre>
	<pre>[:SOURCE]:RADIO:DECT:RFPart:SLOT0 [1] 2 3 4 5 6 7 8 9 10 11:CUSTOM FACCuracy [:SOURCE]:RADIO:DECT:RFPart:SLOT0 [1] 2 3 4 5 6 7 8 9 10 11:CUSTOM? [:SOURCE]:RADIO:DECT:RFPart:SLOT0 [1] 2 3 4 5 6 7 8 9 10 11:LCAPacity [:B] FACCuracy [:SOURCE]:RADIO:DECT:RFPart:SLOT0 [1] 2 3 4 5 6 7 8 9 10 11:LCAPacity[:B]? [:SOURCE]:RADIO:DECT:RFPart:SLOT0 [1] 2 3 4 5 6 7 8 9 10 11:TRAFFic [:B] FACCuracy [:SOURCE]:RADIO:DECT:RFPart:SLOT0 [1] 2 3 4 5 6 7 8 9 10 11:TRAFFic[:B]? [:SOURCE]:RADIO:DECT:RFPart:SLOT0 [1] 2 3 4 5 6 7 8 9 10 11:ZLCapacity [:B] FACCuracy [:SOURCE]:RADIO:DECT:RFPart:SLOT0 [1] 2 3 4 5 6 7 8 9 10 11:ZLCapacity[:B]? [:SOURCE]:RADIO:DECT:RFPart:SLOT0 [1] 2 3 4 5 6 7 8 9 10 11:ZTRAFFic [:B] FACCuracy [:SOURCE]:RADIO:DECT:RFPart:SLOT0 [1] 2 3 4 5 6 7 8 9 10 11:ZTRAFFic[:B]?</pre>
Fall Delay	<pre>[:SOURCE]:RADIO:CUSTOM:BURSt:SHAPE:FALL:DELAy <value> [:SOURCE]:RADIO:CUSTOM:BURSt:SHAPE:FALL:DELAy? [:SOURCE]:RADIO:CUSTOM:BURSt:SHAPE:FDELAy <value> [:SOURCE]:RADIO:CUSTOM:BURSt:SHAPE:FDELAy?</pre>
	<pre>[:SOURCE]:RADIO:<desired format>:BURSt:SHAPE:FALL:DELAy <value> [:SOURCE]:RADIO:<desired format>:BURSt:SHAPE:FALL:DELAy? [:SOURCE]:RADIO:<desired format>:BURSt:SHAPE:FDELAy <value> [:SOURCE]:RADIO:<desired format>:BURSt:SHAPE:FDELAy?</pre>
Fall Time	<pre>[:SOURCE]:RADIO:CUSTOM:BURSt:SHAPE:FALL:TIME <value> [:SOURCE]:RADIO:CUSTOM:BURSt:SHAPE:FALL:TIME? [:SOURCE]:RADIO:CUSTOM:BURSt:SHAPE:FTIME <value> [:SOURCE]:RADIO:CUSTOM:BURSt:SHAPE:FTIME?</pre>
	<pre>[:SOURCE]:RADIO:<desired format>:BURSt:SHAPE:FALL:TIME <value> [:SOURCE]:RADIO:<desired format>:BURSt:SHAPE:FALL:TIME? [:SOURCE]:RADIO:<desired format>:BURSt:SHAPE:FTIME <value> [:SOURCE]:RADIO:<desired format>:BURSt:SHAPE:FTIME?</pre>

Key	SCPI Command
FCOR	<pre>[:SOURce]:RADio:TETra:SLOT[1] 2 3 4:DCSync:FCOR <80-bit value> [:SOURce]:RADio:TETra:SLOT[1] 2 3 4:DCSync:FCOR? [:SOURce]:RADio:TETra:SLOT[1] 2 3 4:DDSync:FCOR <80-bit value> [:SOURce]:RADio:TETra:SLOT[1] 2 3 4:DDSync:FCOR?</pre>
FCorr	<pre>[:SOURce]:RADio:GSM:SLOT0 [1] 2 3 4 5 6 7[:TYPE] FCORrection [:SOURce]:RADio:GSM:SLOT0 [1] 2 3 4 5 6 7[:TYPE]?</pre>
FDEV1_FS	<pre>[:SOURce]:RADio:DECT:PPart:SLOT0 [1] 2 3 4 5 6 7 8 9 10 11:CUSTom FDEV1_FS [:SOURce]:RADio:DECT:PPart:SLOT0 [1] 2 3 4 5 6 7 8 9 10 11:CUSTom? [:SOURce]:RADio:DECT:PPart:SLOT0 [1] 2 3 4 5 6 7 8 9 10 11:LCAPacity [:B] FDEV1_FS [:SOURce]:RADio:DECT:PPart:SLOT0 [1] 2 3 4 5 6 7 8 9 10 11:LCAPacity[:B]? [:SOURce]:RADio:DECT:PPart:SLOT0 [1] 2 3 4 5 6 7 8 9 10 11:TRAFfic [:B] FDEV1_FS [:SOURce]:RADio:DECT:PPart:SLOT0 [1] 2 3 4 5 6 7 8 9 10 11:TRAFfic[:B]? [:SOURce]:RADio:DECT:PPart:SLOT0 [1] 2 3 4 5 6 7 8 9 10 11:ZLCapacity [:B] FDEV1_FS [:SOURce]:RADio:DECT:PPart:SLOT0 [1] 2 3 4 5 6 7 8 9 10 11:ZLCapacity[:B]? [:SOURce]:RADio:DECT:PPart:SLOT0 [1] 2 3 4 5 6 7 8 9 10 11:ZTRAffic [:B] FDEV1_FS [:SOURce]:RADio:DECT:PPart:SLOT0 [1] 2 3 4 5 6 7 8 9 10 11:ZTRAffic[:B]? [:SOURce]:RADio:DECT:RFPart:SLOT0 [1] 2 3 4 5 6 7 8 9 10 11:CUSTom FDEV1_FS [:SOURce]:RADio:DECT:RFPart:SLOT0 [1] 2 3 4 5 6 7 8 9 10 11:CUSTom? [:SOURce]:RADio:DECT:RFPart:SLOT0 [1] 2 3 4 5 6 7 8 9 10 11:LCAPacity [:B] FDEV1_FS [:SOURce]:RADio:DECT:RFPart:SLOT0 [1] 2 3 4 5 6 7 8 9 10 11:LCAPacity[:B]? [:SOURce]:RADio:DECT:RFPart:SLOT0 [1] 2 3 4 5 6 7 8 9 10 11:TRAFfic [:B] FDEV1_FS [:SOURce]:RADio:DECT:RFPart:SLOT0 [1] 2 3 4 5 6 7 8 9 10 11:TRAFfic[:B]? [:SOURce]:RADio:DECT:RFPart:SLOT0 [1] 2 3 4 5 6 7 8 9 10 11:ZLCapacity [:B] FDEV1_FS [:SOURce]:RADio:DECT:RFPart:SLOT0 [1] 2 3 4 5 6 7 8 9 10 11:ZLCapacity[:B]? [:SOURce]:RADio:DECT:RFPart:SLOT0 [1] 2 3 4 5 6 7 8 9 10 11:ZTRAffic[:B] FDEV1_FS [:SOURce]:RADio:DECT:RFPart:SLOT0 [1] 2 3 4 5 6 7 8 9 10 11:ZTRAffic[:B]?</pre>

Key	SCPI Command
FDEV1_HS	[:SOURCE]:RADIO:DECT:PPart:SLOT0 [1] 2 3 4 5 6 7 8 9 10 11:CUSTOM FDEV1_HS [:SOURCE]:RADIO:DECT:PPart:SLOT0 [1] 2 3 4 5 6 7 8 9 10 11:CUSTOM?
	[:SOURCE]:RADIO:DECT:PPart:SLOT0 [1] 2 3 4 5 6 7 8 9 10 11:LCAPacity [:B] FDEV1_HS [:SOURCE]:RADIO:DECT:PPart:SLOT0 [1] 2 3 4 5 6 7 8 9 10 11:LCAPacity[:B]?
	[:SOURCE]:RADIO:DECT:PPart:SLOT0 [1] 2 3 4 5 6 7 8 9 10 11:TRAFFic [:B] FDEV1_HS [:SOURCE]:RADIO:DECT:PPart:SLOT0 [1] 2 3 4 5 6 7 8 9 10 11:TRAFFic[:B]?
	[:SOURCE]:RADIO:DECT:PPart:SLOT0 [1] 2 3 4 5 6 7 8 9 10 11:ZLCapacity [:B] FDEV1_HS [:SOURCE]:RADIO:DECT:PPart:SLOT0 [1] 2 3 4 5 6 7 8 9 10 11:ZLCapacity[:B]?
	[:SOURCE]:RADIO:DECT:PPart:SLOT0 [1] 2 3 4 5 6 7 8 9 10 11:ZTRAFFic [:B] FDEV1_HS [:SOURCE]:RADIO:DECT:PPart:SLOT0 [1] 2 3 4 5 6 7 8 9 10 11:ZTRAFFic[:B]?
	[:SOURCE]:RADIO:DECT:RFPart:SLOT0 [1] 2 3 4 5 6 7 8 9 10 11:CUSTOM FDEV1_HS [:SOURCE]:RADIO:DECT:RFPart:SLOT0 [1] 2 3 4 5 6 7 8 9 10 11:CUSTOM?
	[:SOURCE]:RADIO:DECT:RFPart:SLOT0 [1] 2 3 4 5 6 7 8 9 10 11:LCAPacity [:B] FDEV1_HS [:SOURCE]:RADIO:DECT:RFPart:SLOT0 [1] 2 3 4 5 6 7 8 9 10 11:LCAPacity[:B]?
	[:SOURCE]:RADIO:DECT:RFPart:SLOT0 [1] 2 3 4 5 6 7 8 9 10 11:TRAFFic [:B] FDEV1_HS [:SOURCE]:RADIO:DECT:RFPart:SLOT0 [1] 2 3 4 5 6 7 8 9 10 11:TRAFFic[:B]?
	[:SOURCE]:RADIO:DECT:RFPart:SLOT0 [1] 2 3 4 5 6 7 8 9 10 11:ZLCapacity [:B] FDEV1_HS [:SOURCE]:RADIO:DECT:RFPart:SLOT0 [1] 2 3 4 5 6 7 8 9 10 11:ZLCapacity[:B]?
	[:SOURCE]:RADIO:DECT:RFPart:SLOT0 [1] 2 3 4 5 6 7 8 9 10 11:ZTRAFFic[:B] FDEV1_HS [:SOURCE]:RADIO:DECT:RFPart:SLOT0 [1] 2 3 4 5 6 7 8 9 10 11:ZTRAFFic[:B]?

Key	SCPI Command
FDEV2_FS	<pre>[:SOURce]:RADio:DECT:PPart:SLOT0 [1] 2 3 4 5 6 7 8 9 10 11:CUSTom FDEV2_FS [:SOURce]:RADio:DECT:PPart:SLOT0 [1] 2 3 4 5 6 7 8 9 10 11:CUSTom? [:SOURce]:RADio:DECT:PPart:SLOT0 [1] 2 3 4 5 6 7 8 9 10 11:LCAPacity[:B] FDEV2_FS [:SOURce]:RADio:DECT:PPart:SLOT0 [1] 2 3 4 5 6 7 8 9 10 11:LCAPacity [:B]? [:SOURce]:RADio:DECT:PPart:SLOT0 [1] 2 3 4 5 6 7 8 9 10 11:TRAFfic[:B] FDEV2_FS [:SOURce]:RADio:DECT:PPart:SLOT0 [1] 2 3 4 5 6 7 8 9 10 11:TRAFfic [:B]? [:SOURce]:RADio:DECT:PPart:SLOT0 [1] 2 3 4 5 6 7 8 9 10 11:ZLCAPacity[:B] FDEV2_FS [:SOURce]:RADio:DECT:PPart:SLOT0 [1] 2 3 4 5 6 7 8 9 10 11:ZLCAPacity [:B]? [:SOURce]:RADio:DECT:PPart:SLOT0 [1] 2 3 4 5 6 7 8 9 10 11:ZTRAFfic[:B] FDEV2_FS [:SOURce]:RADio:DECT:PPart:SLOT0 [1] 2 3 4 5 6 7 8 9 10 11:ZTRAFfic [:B]? [:SOURce]:RADio:DECT:RFPart:SLOT0 [1] 2 3 4 5 6 7 8 9 10 11:CUSTom FDEV2_FS [:SOURce]:RADio:DECT:RFPart:SLOT0 [1] 2 3 4 5 6 7 8 9 10 11:CUSTom? [:SOURce]:RADio:DECT:RFPart:SLOT0 [1] 2 3 4 5 6 7 8 9 10 11:LCAPacity[:B] FDEV2_FS [:SOURce]:RADio:DECT:RFPart:SLOT0 [1] 2 3 4 5 6 7 8 9 10 11:LCAPacity [:B]? [:SOURce]:RADio:DECT:RFPart:SLOT0 [1] 2 3 4 5 6 7 8 9 10 11:TRAFfic[:B] FDEV2_FS [:SOURce]:RADio:DECT:RFPart:SLOT0 [1] 2 3 4 5 6 7 8 9 10 11:TRAFfic[:B]? [:SOURce]:RADio:DECT:RFPart:SLOT0 [1] 2 3 4 5 6 7 8 9 10 11:ZLCAPacity[:B] FDEV2_FS [:SOURce]:RADio:DECT:RFPart:SLOT0 [1] 2 3 4 5 6 7 8 9 10 11:ZLCAPacity [:B]? [:SOURce]:RADio:DECT:RFPart:SLOT0 [1] 2 3 4 5 6 7 8 9 10 11:ZTRAFfic[:B] FDEV2_FS [:SOURce]:RADio:DECT:RFPart:SLOT0 [1] 2 3 4 5 6 7 8 9 10 11:ZTRAFfic [:B]?</pre>
Filter	<pre>[:SOURce]:RADio:EDGE:FILTer RNYQuist NYQuist GAUSSian RECTangle IS95 IS95_EQ IS95_MOD IS95_MOD_EQ EDGE AC4Fm IS2000SR3DS UGGaussian "user FIR" [:SOURce]:RADio:EDGE:FILTer? [:SOURce]:RADio:GSM:FILTer RNYQuist NYQuist GAUSSian RECTangle IS95 IS95_EQ IS95_MOD IS95_MOD_EQ AC4Fm IS2000SR3DS UGGaussian "user FIR" [:SOURce]:RADio:GSM:FILTer? [:SOURce]:RADio:DECT CUSTOM NADC PDC PHS TETRA:FILTer RNYQuist NYQuist GAUSSian RECTangle "<file name>" [:SOURce]:RADio:DECT:FILTer?</pre>
Filter Alpha	<pre>[:SOURce]:RADio:CUSTom:ALPHA <value> [:SOURce]:RADio:CUSTom:ALPHA? [:SOURce]:RADio:<desired format>:ALPHA <value> [:SOURce]:RADio:<desired format>:ALPHA?</pre>

Key	SCPI Command
Filter BbT	<pre>[:SOURce]:RADio:CUSTom:BBT <value> [:SOURce]:RADio:CUSTom:BBT? [:SOURce]:RADio:<desired format>:BBT <value> [:SOURce]:RADio:<desired format>:BBT?</pre>
	<pre>[:SOURce]:RADio:<desired format>:BBT <value> [:SOURce]:RADio:<desired format>:BBT?</pre>

Key	SCPI Command
FIX4	[:SOURce]:RADio:CUSTom:DATA:FIX4 <0-15> [:SOURce]:RADio:CUSTom:DATA:FIX4?
	[:SOURce]:RADio:DECT:DATA FIX4 [:SOURce]:RADio:DECT:DATA:FIX4 <0-15> [:SOURce]:RADio:DECT:DATA:FIX4?
	[:SOURce]:RADio:DECT:PPart:SLOT0 [1] 2 3 4 5 6 7 8 9 10 11:CUSTom FIX4 [:SOURce]:RADio:DECT:PPart:SLOT0 [1] 2 3 4 5 6 7 8 9 10 11:CUSTom: FIX4 <0-15> [:SOURce]:RADio:DECT:PPart:SLOT0 [1] 2 3 4 5 6 7 8 9 10 11:CUSTom:FIX4?
	[:SOURce]:RADio:DECT:PPart:SLOT0 [1] 2 3 4 5 6 7 8 9 10 11:LCAPacity [:B] FIX4 [:SOURce]:RADio:DECT:PPart:SLOT0 [1] 2 3 4 5 6 7 8 9 10 11:LCAPacity[:B]: FIX4 <0-15> [:SOURce]:RADio:DECT:PPart:SLOT0 [1] 2 3 4 5 6 7 8 9 10 11:LCAPacity[:B]: FIX4?
	[:SOURce]:RADio:DECT:PPart:SLOT0 [1] 2 3 4 5 6 7 8 9 10 11:TRAFfic[:B] FIX4 [:SOURce]:RADio:DECT:PPart:SLOT0 [1] 2 3 4 5 6 7 8 9 10 11:TRAFfic[:B]: FIX4 <0-15> [:SOURce]:RADio:DECT:PPart:SLOT0 [1] 2 3 4 5 6 7 8 9 10 11:TRAFfic[:B]:FIX4?
	[:SOURce]:RADio:DECT:PPart:SLOT0 [1] 2 3 4 5 6 7 8 9 10 11:ZLCapacity [:B] FIX4 [:SOURce]:RADio:DECT:PPart:SLOT0 [1] 2 3 4 5 6 7 8 9 10 11:ZLCapacity[:B]: FIX4 <0-15> [:SOURce]:RADio:DECT:PPart:SLOT0 [1] 2 3 4 5 6 7 8 9 10 11:ZLCapacity[:B]: FIX4?
	[:SOURce]:RADio:DECT:PPart:SLOT0 [1] 2 3 4 5 6 7 8 9 10 11:ZTRAffic[:B] FIX4 [:SOURce]:RADio:DECT:PPart:SLOT0 [1] 2 3 4 5 6 7 8 9 10 11:ZTRAffic[:B]: FIX4 <0-15> [:SOURce]:RADio:DECT:PPart:SLOT0 [1] 2 3 4 5 6 7 8 9 10 11:ZTRAffic[:B]: FIX4?
	[:SOURce]:RADio:DECT:RFPart:SLOT0 [1] 2 3 4 5 6 7 8 9 10 11:CUSTom FIX4 [:SOURce]:RADio:DECT:RFPart:SLOT0 [1] 2 3 4 5 6 7 8 9 10 11:CUSTom: FIX4 <0-15> [:SOURce]:RADio:DECT:RFPart:SLOT0 [1] 2 3 4 5 6 7 8 9 10 11:CUSTom:FIX4?
	[:SOURce]:RADio:DECT:RFPart:SLOT0 [1] 2 3 4 5 6 7 8 9 10 11:LCAPacity[:B] FIX4 [:SOURce]:RADio:DECT:RFPart:SLOT0 [1] 2 3 4 5 6 7 8 9 10 11:LCAPacity[:B]: FIX4 <0-15> [:SOURce]:RADio:DECT:RFPart:SLOT0 [1] 2 3 4 5 6 7 8 9 10 11:LCAPacity[:B]: FIX4?
	[:SOURce]:RADio:DECT:RFPart:SLOT0 [1] 2 3 4 5 6 7 8 9 10 11:TRAFfic[:B] FIX4 [:SOURce]:RADio:DECT:RFPart:SLOT0 [1] 2 3 4 5 6 7 8 9 10 11:TRAFfic[:B]: FIX4 <0-15> [:SOURce]:RADio:DECT:RFPart:SLOT0 [1] 2 3 4 5 6 7 8 9 10 11:TRAFfic[:B]: FIX4?

Key	SCPI Command
FIX4 continued	<pre>[:SOURCE]:RADIO:DECT:RFPart:SLOT0 [1] 2 3 4 5 6 7 8 9 10 11:ZLCapacity [:B] FIX4 [:SOURCE]:RADIO:DECT:RFPart:SLOT0 [1] 2 3 4 5 6 7 8 9 10 11:ZLCapacity[:B]: FIX4 <0-15> [:SOURCE]:RADIO:DECT:RFPart:SLOT0 [1] 2 3 4 5 6 7 8 9 10 11:ZLCapacity[:B]: FIX4?</pre> <pre>[:SOURCE]:RADIO:DECT:RFPart:SLOT0 [1] 2 3 4 5 6 7 8 9 10 11:ZTRaffic [:B] FIX4 [:SOURCE]:RADIO:DECT:RFPart:SLOT0 [1] 2 3 4 5 6 7 8 9 10 11:ZTRaffic[:B]: FIX4 <0-15> [:SOURCE]:RADIO:DECT:RFPart:SLOT0 [1] 2 3 4 5 6 7 8 9 10 11:ZTRaffic[:B]: FIX4?</pre>
	<pre>[:SOURCE]:RADIO:<desired format>:DATA FIX4 [:SOURCE]:RADIO:<desired format>:DATA:FIX4 <0-15> [:SOURCE]:RADIO:<desired format>:DATA:FIX4?</pre> <pre>[:SOURCE]:RADIO:EDGE GSM:SLOT0 [1] 2 3 4 5 6 7:CUSTOM FIX4 [:SOURCE]:RADIO:EDGE GSM:SLOT0 [1] 2 3 4 5 6 7:CUSTOM:FIX4 <0-15> [:SOURCE]:RADIO:EDGE GSM:SLOT0 [1] 2 3 4 5 6 7:CUSTOM:FIX4?</pre> <pre>[:SOURCE]:RADIO:EDGE GSM:SLOT0 [1] 2 3 4 5 6 7:NORMAL:ENCRyption FIX4 [:SOURCE]:RADIO:EDGE GSM:SLOT0 [1] 2 3 4 5 6 7:NORMAL:ENCRyption:FIX4 <0-15> [:SOURCE]:RADIO:EDGE GSM:SLOT0 [1] 2 3 4 5 6 7:NORMAL:ENCRyption:FIX4?</pre>
	<pre>[:SOURCE]:RADIO:GSM:SLOT0 [1] 2 3 4 5 6 7:SYNC:ENCRyption FIX4 [:SOURCE]:RADIO:GSM:SLOT0 [1] 2 3 4 5 6 7:SYNC:ENCRyption:FIX4 <0-15> [:SOURCE]:RADIO:GSM:SLOT0 [1] 2 3 4 5 6 7:SYNC:ENCRyption:FIX4?</pre> <pre>[:SOURCE]:RADIO:GSM:DATA FIX4 [:SOURCE]:RADIO:GSM:DATA:FIX4 <0-15> [:SOURCE]:RADIO:GSM:DATA:FIX4?</pre> <pre>[:SOURCE]:RADIO:GSM:SLOT0 [1] 2 3 4 5 6 7:ACCESS:ENCRyption FIX4 [:SOURCE]:RADIO:GSM:SLOT0 [1] 2 3 4 5 6 7:ACCESS:ENCRyption:FIX4 <0-15> [:SOURCE]:RADIO:GSM:SLOT0 [1] 2 3 4 5 6 7:ACCESS:ENCRyption:FIX4?</pre>
	<pre>[:SOURCE]:RADIO:GSM EDGE:SLOT0 [1] 2 3 4 5 6 7:CUSTOM FIX4 [:SOURCE]:RADIO:GSM EDGE:SLOT0 [1] 2 3 4 5 6 7:CUSTOM:FIX4 <0-15> [:SOURCE]:RADIO:GSM EDGE:SLOT0 [1] 2 3 4 5 6 7:CUSTOM:FIX4?</pre> <pre>[:SOURCE]:RADIO:GSM EDGE:SLOT0 [1] 2 3 4 5 6 7:NORMAL:ENCRyption FIX4 [:SOURCE]:RADIO:GSM EDGE:SLOT0 [1] 2 3 4 5 6 7:NORMAL:ENCRyption:FIX4 <0-15> [:SOURCE]:RADIO:GSM EDGE:SLOT0 [1] 2 3 4 5 6 7:NORMAL:ENCRyption:FIX4?</pre>

Key	SCPI Command
FIX 4 continued	<pre>[:SOURce]:RADio[:NADC]:DATA FIX4 [:SOURce]:RADio[:NADC]:DATA:FIX4 <0-15> [:SOURce]:RADio[:NADC]:DATA:FIX4? [:SOURce]:RADio[:NADC]:SLOT[1] 2 3 4 5 6:DCUStom FIX4 [:SOURce]:RADio[:NADC]:SLOT[1] 2 3 4 5 6:DCUStom:FIX4 <0-15> [:SOURce]:RADio[:NADC]:SLOT[1] 2 3 4 5 6:DCUStom:FIX4? [:SOURce]:RADio[:NADC]:SLOT[1] 2 3 4 5 6:DTCHannel[:DATA] FIX4 [:SOURce]:RADio[:NADC]:SLOT[1] 2 3 4 5 6:DTCHannel[:DATA]:FIX4 <0-15> [:SOURce]:RADio[:NADC]:SLOT[1] 2 3 4 5 6:DTCHannel[:DATA]:FIX4? [:SOURce]:RADio[:NADC]:SLOT[1] 2 3 4 5 6:UCUStom FIX4 [:SOURce]:RADio[:NADC]:SLOT[1] 2 3 4 5 6:UCUStom:FIX4 <0-15> [:SOURce]:RADio[:NADC]:SLOT[1] 2 3 4 5 6:UCUStom:FIX4? [:SOURce]:RADio[:NADC]:SLOT[1] 2 3 4 5 6:UTCHannel[:DATA] FIX4 [:SOURce]:RADio[:NADC]:SLOT[1] 2 3 4 5 6:UTCHannel[:DATA]:FIX4 <0-15> [:SOURce]:RADio[:NADC]:SLOT[1] 2 3 4 5 6:UTCHannel[:DATA]:FIX4?</pre>
	<pre>[:SOURce]:RADio:PDC:DATA FIX4 [:SOURce]:RADio:PDC:DATA:FIX4 <0-15> [:SOURce]:RADio:PDC:DATA:FIX4? [:SOURce]:RADio:PDC:SLOT0 [1] 2 3 4 5:DCUStom FIX4 [:SOURce]:RADio:PDC:SLOT0 [1] 2 3 4 5:DCUStom:FIX4 <0-15> [:SOURce]:RADio:PDC:SLOT0 [1] 2 3 4 5:DCUStom:FIX4? [:SOURce]:RADio:PDC:SLOT0 [1] 2 3 4 5:DTCHannel[:TCHannel] FIX4 [:SOURce]:RADio:PDC:SLOT0 [1] 2 3 4 5:DTCHannel[:TCHannel]:FIX4 <0-15> [:SOURce]:RADio:PDC:SLOT0 [1] 2 3 4 5:DTCHannel[:TCHannel]:FIX4? [:SOURce]:RADio:PDC:SLOT0 [1] 2 3 4 5:UCUStom FIX4 [:SOURce]:RADio:PDC:SLOT0 [1] 2 3 4 5:UCUStom:FIX4 <0-15> [:SOURce]:RADio:PDC:SLOT0 [1] 2 3 4 5:UCUStom:FIX4? [:SOURce]:RADio:PDC:SLOT0 [1] 2 3 4 5:UTCHannel[:TCHannel] FIX [:SOURce]:RADio:PDC:SLOT0 [1] 2 3 4 5:UTCHannel[:TCHannel]:FIX4 <0-15> [:SOURce]:RADio:PDC:SLOT0 [1] 2 3 4 5:UTCHannel[:TCHannel]:FIX4?</pre>
	<pre>[:SOURce]:RADio:PHS:DATA FIX4 [:SOURce]:RADio:PHS:DATA:FIX4 <0-15> [:SOURce]:RADio:PHS:DATA:FIX4? [:SOURce]:RADio:PHS:DLINK:SLOT[1] 2 3 4:CUSTom:FIX4 [:SOURce]:RADio:PHS:DLINK:SLOT[1] 2 3 4:CUSTom:FIX4 <0-15> [:SOURce]:RADio:PHS:DLINK:SLOT[1] 2 3 4:CUSTom:FIX4? [:SOURce]:RADio:PHS:DLINK:SLOT[1] 2 3 4:TCHannel[:TCHannel] FIX4 [:SOURce]:RADio:PHS:DLINK:SLOT[1] 2 3 4:TCHannel[:TCHannel]:FIX4 <0-15> [:SOURce]:RADio:PHS:DLINK:SLOT[1] 2 3 4:TCHannel[:TCHannel]:FIX4? [:SOURce]:RADio:PHS:ULINK:SLOT[1] 2 3 4:CUSTom:FIX4 [:SOURce]:RADio:PHS:ULINK:SLOT[1] 2 3 4:CUSTom:FIX4 <0-15> [:SOURce]:RADio:PHS:ULINK:SLOT[1] 2 3 4:CUSTom:FIX4? [:SOURce]:RADio:PHS:ULINK:SLOT[1] 2 3 4:TCHannel[:TCHannel] FIX4 [:SOURce]:RADio:PHS:ULINK:SLOT[1] 2 3 4:TCHannel[:TCHannel]:FIX4 <0-15> [:SOURce]:RADio:PHS:ULINK:SLOT[1] 2 3 4:TCHannel[:TCHannel]:FIX4?</pre>

Key	SCPI Command
FIX4 continued	<pre>[:SOURCE]:RADio:TETRa:DATA FIX4 [:SOURCE]:RADio:TETRa:DATA:FIX4 <0-15> [:SOURCE]:RADio:TETRa:DATA:FIX4? [:SOURCE]:RADio:TETRa:SLOT[1] 2 3 4:DCNormal[:DATA] FIX4 [:SOURCE]:RADio:TETRa:SLOT[1] 2 3 4:DCNormal[:DATA]:FIX4 <0-15> [:SOURCE]:RADio:TETRa:SLOT[1] 2 3 4:DCNormal[:DATA]:FIX4? [:SOURCE]:RADio:TETRa:SLOT[1] 2 3 4:DCSync[:DATA] FIX4 [:SOURCE]:RADio:TETRa:SLOT[1] 2 3 4:DCSync[:DATA]:FIX4 <0-15> [:SOURCE]:RADio:TETRa:SLOT[1] 2 3 4:DCSync[:DATA]:FIX4? [:SOURCE]:RADio:TETRa:SLOT[1] 2 3 4:DDCustom[:DATA] FIX4 [:SOURCE]:RADio:TETRa:SLOT[1] 2 3 4:DDCustom[:DATA]:FIX4 <0-15> [:SOURCE]:RADio:TETRa:SLOT[1] 2 3 4:DDCustom[:DATA]:FIX4? [:SOURCE]:RADio:TETRa:SLOT[1] 2 3 4:DDNormal[:DATA] FIX4 [:SOURCE]:RADio:TETRa:SLOT[1] 2 3 4:DDNormal[:DATA]:FIX4 <0-15> [:SOURCE]:RADio:TETRa:SLOT[1] 2 3 4:DDNormal[:DATA]:FIX4? [:SOURCE]:RADio:TETRa:SLOT[1] 2 3 4:DDSync[:DATA] FIX4 [:SOURCE]:RADio:TETRa:SLOT[1] 2 3 4:DDSync[:DATA]:FIX4 <0-15> [:SOURCE]:RADio:TETRa:SLOT[1] 2 3 4:DDSync[:DATA]:FIX4? [:SOURCE]:RADio:TETRa:SLOT[1] 2 3 4:UC1[:DATA] FIX4 [:SOURCE]:RADio:TETRa:SLOT[1] 2 3 4:UC1[:DATA]:FIX4 <0-15> [:SOURCE]:RADio:TETRa:SLOT[1] 2 3 4:UC1[:DATA]:FIX4? [:SOURCE]:RADio:TETRa:SLOT[1] 2 3 4:UC2[:DATA] FIX4 [:SOURCE]:RADio:TETRa:SLOT[1] 2 3 4:UC2[:DATA]:FIX4 <0-15> [:SOURCE]:RADio:TETRa:SLOT[1] 2 3 4:UC2[:DATA]:FIX4? [:SOURCE]:RADio:TETRa:SLOT[1] 2 3 4:UNORmal[:DATA] FIX4 [:SOURCE]:RADio:TETRa:SLOT[1] 2 3 4:UNORmal[:DATA]:FIX4 <0-15> [:SOURCE]:RADio:TETRa:SLOT[1] 2 3 4:UNORmal[:DATA]:FIX4? [:SOURCE]:RADio:TETRa:SLOT[1] 2 3 4:UCUSTom FIX4 [:SOURCE]:RADio:TETRa:SLOT[1] 2 3 4:UCUSTom:FIX4 <0-15> [:SOURCE]:RADio:TETRa:SLOT[1] 2 3 4:UCUSTom:FIX4? [:SOURCE]:RADio:TETRa:SLOT[1] 2 3 4:DCCustom FIX4 [:SOURCE]:RADio:TETRa:SLOT[1] 2 3 4:DCCustom:FIX4 <0-15> [:SOURCE]:RADio:TETRa:SLOT[1] 2 3 4:DCCustom:FIX4?</pre>
Frame Repeat Single Cont	<pre>[:SOURCE]:RADio:<desired format>:REPeat SINGLE CONTinuous [:SOURCE]:RADio:<desired format>:REPeat?</pre>
Frame Trigger	<pre>[:SOURCE]:RADio:<desired format>:TRIGger[:SOURCE] KEY EXT BUS [:SOURCE]:RADio:<desired format>:TRIGger[:SOURCE]? [:SOURCE]:RADio:EDGE:BNCMux:EVENT FTRigger [:SOURCE]:RADio:EDGE:BNCMux:EVENT?</pre>
Freq Channels Off On	<pre>[:SOURCE]:RADio:<desired format>:FCHannel[:STATE] ON OFF 1 0 [:SOURCE]:RADio:<desired format>:FCHannel[:STATE]?</pre>

Key	SCPI Command
Freq Dev	[:SOURce]:RADio:CUSTom:MODulation:FSK[:DEVIation] <val><unit> [:SOURce]:RADio:CUSTom:MODulation:FSK[:DEVIation]?
	[:SOURce]:RADio:<desired format>:MODulation:FSK[:DEVIation] <val><unit> [:SOURce]:RADio:<desired format>:MODulation:FSK[:DEVIation]?
G	[:SOURce]:RADio:EDGE:SLOT0 [1] 2 3 4 5 6 7:CUSTom:GUARD <24 or 27-bit pattern> [:SOURce]:RADio:EDGE:SLOT0 [1] 2 3 4 5 6 7:CUSTom:GUARD?
	[:SOURce]:RADio:EDGE:SLOT0 [1] 2 3 4 5 6 7:NORMal:GUARD <24 or 27-bit pattern> [:SOURce]:RADio:EDGE:SLOT0 [1] 2 3 4 5 6 7:NORMal:GUARD?
Gated	[:SOURce]:RADio:<desired format>:TRIGger[:SOURce]:EXTernal[:TYPE] GATE [:SOURce]:RADio:<desired format>:TRIGger[:SOURce]:EXTernal[:TYPE]?
Gated Clock	[:SOURce]:RADio:EDGE:BNCMux:DCOut GCLock [:SOURce]:RADio:EDGE:BNCMux:DCOut?
Gaussian	[:SOURce]:RADio:CUSTom:FILTer GAUSSian [:SOURce]:RADio:CUSTom:FILTer?
	[:SOURce]:RADio:<desired format>:FILTer GAUSSian [:SOURce]:RADio:<desired format>:FILTer?
Gray Coded QPSK	[:SOURce]:RADio:CUSTom:MODulation[:TYPE] GRAYQPSK [:SOURce]:RADio:CUSTom:MODulation[:TYPE]?
	[:SOURce]:RADio:<desired format>:MODulation[:TYPE] GRAYQPSK [:SOURce]:RADio:<desired format>:MODulation[:TYPE]?
GSM Off On	[:SOURce]:RADio:GSM[:STATE] ON OFF 1 0 [:SOURce]:RADio:GSM[:STATE]?
IDLE	[:SOURce]:RADio:PHS:DLINK:SLOT[1] 2 3 4:SCHannel:IDLE <bit pattern> [:SOURce]:RADio:PHS:DLINK:SLOT[1] 2 3 4:SCHannel:IDLE?
	[:SOURce]:RADio:PHS:ULINK:SLOT[1] 2 3 4:SCHannel:IDLE <bit pattern> [:SOURce]:RADio:PHS:ULINK:SLOT[1] 2 3 4:SCHannel:IDLE?
Interleave Gating	[:SOURce]:RADio:EDGE:BNCMux:SSOut IGAT [:SOURce]:RADio:EDGE:BNCMux:SSOut?
I/Q Scaling	[:SOURce]:RADio:<desired value>:IQ:SCALE <value> [:SOURce]:RADio:<desired value>:IQ:SCALE?
IS-95	[:SOURce]:RADio:CUSTom:FILTer IS95 [:SOURce]:RADio:CUSTom:FILTer?
	[:SOURce]:RADio:<desired format>:FILTer IS95 [:SOURce]:RADio:<desired format>:FILTer?
IS-95 Mod	[:SOURce]:RADio:CUSTom:FILTer IS95_MOD [:SOURce]:RADio:CUSTom:FILTer?
	[:SOURce]:RADio:<desired format>:FILTer IS95_MOD [:SOURce]:RADio:<desired format>:FILTer?

Key	SCPI Command
IS-95 Mod w/EQ	[:SOURCE]:RADIO:CUSTOM:FILTER IS95_MOD_EQ [:SOURCE]:RADIO:CUSTOM:FILTER?
	[:SOURCE]:RADIO:<desired format>:FILTER IS95_MOD_EQ [:SOURCE]:RADIO:<desired format>:FILTER?
IS-95 w/EQ	[:SOURCE]:RADIO:CUSTOM:FILTER IS95_EQ [:SOURCE]:RADIO:CUSTOM:FILTER?
	[:SOURCE]:RADIO:<desired format>:FILTER IS95_EQ [:SOURCE]:RADIO:<desired format>:FILTER?
IS95 OQPSK	[:SOURCE]:RADIO:CUSTOM:MODULATION[:TYPE] IS95OQPSK [:SOURCE]:RADIO:CUSTOM:MODULATION[:TYPE]?
	[:SOURCE]:RADIO:<desired format>:MODULATION[:TYPE] IS95OQPSK [:SOURCE]:RADIO:<desired format>:MODULATION[:TYPE]?
IS95 QPSK	[:SOURCE]:RADIO:CUSTOM:MODULATION[:TYPE] IS95QPSK [:SOURCE]:RADIO:CUSTOM:MODULATION[:TYPE]?
	[:SOURCE]:RADIO:<desired format>:MODULATION[:TYPE] IS95QPSK [:SOURCE]:RADIO:<desired format>:MODULATION[:TYPE]?
Key	[:SOURCE]:RADIO:CUSTOM:TRIGGER[:SOURCE] KEY [:SOURCE]:RADIO:CUSTOM:TRIGGER[:SOURCE]?
	[:SOURCE]:RADIO:<desired fomrat>:TRIGGER[:SOURCE] KEY [:SOURCE]:RADIO:<desired fomrat>:TRIGGER[:SOURCE]?
Low Capacity	[:SOURCE]:RADIO:DECT:PPART:SLOT0 [1] 2 3 4 5 6 7 8 9 10 11 [:TYPE] LCapacity [:SOURCE]:RADIO:DECT:PPART:SLOT0 [1] 2 3 4 5 6 7 8 9 10 11[:TYPE]?
	[:SOURCE]:RADIO:DECT:RFPART:SLOT0 [1] 2 3 4 5 6 7 8 9 10 11 [:TYPE] LCapacity [:SOURCE]:RADIO:DECT:RFPART:SLOT0 [1] 2 3 4 5 6 7 8 9 10 11[:TYPE]?
Low Capacity with Z field	[:SOURCE]:RADIO:DECT:PPART:SLOT0 [1] 2 3 4 5 6 7 8 9 10 11 [:TYPE] ZLCapacity [:SOURCE]:RADIO:DECT:PPART:SLOT0 [1] 2 3 4 5 6 7 8 9 10 11[:TYPE]?
	[:SOURCE]:RADIO:DECT:RFPART:SLOT0 [1] 2 3 4 5 6 7 8 9 10 11 [:TYPE] ZLCapacity [:SOURCE]:RADIO:DECT:RFPART:SLOT0 [1] 2 3 4 5 6 7 8 9 10 11[:TYPE]?
Manual Reset & Run	[:SOURCE]:RADIO:<desired format>:TRIGGER[:SOURCE]:EXTERNAL[:TYPE] MANUAL [:SOURCE]:RADIO:<desired format>:TRIGGER[:SOURCE]:EXTERNAL[:TYPE]?
Mobile	[:SOURCE]:RADIO[:NADC]:FCHANNEL:BAND MOBILE [:SOURCE]:RADIO[:NADC]:FCHANNEL:BAND?

Key	SCPI Command
Modulation Type	[:SOURce]:RADio:CUSTom:MODulation[:TYPE] BPSK QPSK IS95QPSK GRAYQPSK OQPSK IS95OQPSK P4DQPSK PSK8 PSK16 D8PSK MSK FSK2 FSK4 FSK8 FSK16 C4FM QAM4 QAM16 QAM32 QAM64 QAM256 UIQ UFSK [:SOURce]:RADio:CUSTom:MODulation[:TYPE]?
	[:SOURce]:RADio:<desired format>:MODulation[:TYPE] BPSK QPSK IS95QPSK GRAYQPSK OQPSK IS95OQPSK P4DQPSK PSK8 PSK16 D8PSK MSK FSK2 FSK4 FSK8 FSK16 C4FM QAM4 QAM16 QAM32 QAM64 QAM256 UIQ UFSK [:SOURce]:RADio:<desired format>:MODulation[:TYPE]?
MSK	[:SOURce]:RADio:CUSTom:MODulation[:TYPE] MSK [:SOURce]:RADio:CUSTom:MODulation[:TYPE]?
	[:SOURce]:RADio:<desired format>:MODulation[:TYPE] MSK [:SOURce]:RADio:<desired format>:MODulation[:TYPE]?
Multiframe Channel	[:SOURce]:RADio:EDGE:SLOT0 [1] 2 3 4 5 6 7:NORMal:ENCRyption PN9 PN15 FIX4 "<filename>" EXT P4 P8 P16 P32 P64 DMCS9 UMCS9 DMCS5 UMCS5 ETCH:F43 UNCodeD [:SOURce]:RADio:EDGE:SLOT0 [1] 2 3 4 5 6 7:NORMal:ENCRyption?
Multiframe Data	[:SOURce]:RADio:EDGE:BNCMux:DOut MDATA [:SOURce]:RADio:EDGE:BNCMux:DOut?
Multiframe Trigger	[:SOURce]:RADio:EDGE:BNCMux:EVENT MTRigger [:SOURce]:RADio:EDGE:BNCMux:EVENT?
NADC Off On	[:SOURce]:RADio[:NADC][:STATe] ON OFF 1 0 [:SOURce]:RADio[:NADC][:STATe]?
None	[:SOURce]:RADio:CUSTom:STANdard:SElect NONE [:SOURce]:RADio:CUSTom:STANdard:SElect?
Normal	[:SOURce]:RADio:EDGE GSM:SLOT0 [1] 2 3 4 5 6 7[:TYPE] NORMAl [:SOURce]:RADio:EDGE GSM:SLOT0 [1] 2 3 4 5 6 7[:TYPE]?
Normal All	[:SOURce]:RADio:EDGE GSM:SLOT0 [1] 2 3 4 5 6 7[:TYPE] NORMAl_ALL [:SOURce]:RADio:EDGE GSM:SLOT0 [1] 2 3 4 5 6 7[:TYPE]?
Nyquist	[:SOURce]:RADio:CUSTom:FILTer NYQuist [:SOURce]:RADio:CUSTom:FILTer?
	[:SOURce]:RADio:<desired format>:FILTer NYQuist [:SOURce]:RADio:<desired format>:FILTer?
Offset Q Off On	:MEMory:DATA:IQ "<file name>",<offsetQ,num_states,i0,q0,i1,q1,... [,diff_state,num_diff_states,diff0,diff1,...] :MEMory:DATA:IQ? "<file name>"
Optimize FIR For EVM ACP	[:SOURce]:RADio:CUSTom:CHANnel EVM ACP [:SOURce]:RADio:CUSTom:CHANnel?
	[:SOURce]:RADio:<desired format>:CHANnel EVM ACP [:SOURce]:RADio:<desired format>:CHANnel?

Key	SCPI Command
OQPSK	[:SOURCE]:RADio:CUSTom:MODulation[:TYPE] OQPSK [:SOURCE]:RADio:CUSTom:MODulation[:TYPE]?
	[:SOURCE]:RADio:<desired format>:MODulation[:TYPE] OQPSK [:SOURCE]:RADio:<desired format>:MODulation[:TYPE]?
P	[:SOURCE]:RADio:DECT:PPart:SLOT0 [1] 2 3 4 5 6 7 8 9 10 11:LCAPacity: P <16-bit value> [:SOURCE]:RADio:DECT:PPart:SLOT0 [1] 2 3 4 5 6 7 8 9 10 11:LCAPacity:P? [:SOURCE]:RADio:DECT:PPart:SLOT0 [1] 2 3 4 5 6 7 8 9 10 11:TRAFfic: P <16-bit value> [:SOURCE]:RADio:DECT:PPart:SLOT0 [1] 2 3 4 5 6 7 8 9 10 11:TRAFfic:P? [:SOURCE]:RADio:DECT:PPart:SLOT0 [1] 2 3 4 5 6 7 8 9 10 11:ZLCapacity: P <16-bit value> [:SOURCE]:RADio:DECT:PPart:SLOT0 [1] 2 3 4 5 6 7 8 9 10 11:ZLCapacity:P? [:SOURCE]:RADio:DECT:PPart:SLOT0 [1] 2 3 4 5 6 7 8 9 10 11:ZTRAffic: P <16-bit value> [:SOURCE]:RADio:DECT:PPart:SLOT0 [1] 2 3 4 5 6 7 8 9 10 11:ZTRAffic:P? [:SOURCE]:RADio:DECT:RFPart:SLOT0 [1] 2 3 4 5 6 7 8 9 10 11:DUMM[1]: P <16-bit value> [:SOURCE]:RADio:DECT:RFPart:SLOT0 [1] 2 3 4 5 6 7 8 9 10 11:DUMM[1]:P? [:SOURCE]:RADio:DECT:RFPart:SLOT0 [1] 2 3 4 5 6 7 8 9 10 11:DUMM2: P <16-bit value> [:SOURCE]:RADio:DECT:RFPart:SLOT0 [1] 2 3 4 5 6 7 8 9 10 11:DUMM2:P? [:SOURCE]:RADio:DECT:RFPart:SLOT0 [1] 2 3 4 5 6 7 8 9 10 11:LCAPacity: P <16-bit value> [:SOURCE]:RADio:DECT:RFPart:SLOT0 [1] 2 3 4 5 6 7 8 9 10 11:LCAPacity:P? [:SOURCE]:RADio:DECT:RFPart:SLOT0 [1] 2 3 4 5 6 7 8 9 10 11:TRAFfic: P <16-bit value> [:SOURCE]:RADio:DECT:RFPart:SLOT0 [1] 2 3 4 5 6 7 8 9 10 11:TRAFfic:P? [:SOURCE]:RADio:DECT:RFart:SLOT0 [1] 2 3 4 5 6 7 8 9 10 11:ZLCapacity: P <16-bit value> [:SOURCE]:RADio:DECT:RFart:SLOT0 [1] 2 3 4 5 6 7 8 9 10 11:ZLCapacity:P? [:SOURCE]:RADio:DECT:RFart:SLOT0 [1] 2 3 4 5 6 7 8 9 10 11:ZTRAffic: P <16-bit value> [:SOURCE]:RADio:DECT:RFart:SLOT0 [1] 2 3 4 5 6 7 8 9 10 11:ZTRAffic:P?
P-GSM Base	[:SOURCE]:RADio:EDGE GSM:FCHannel:BAND BPGSm [:SOURCE]:RADio:EDGE GSM:FCHannel:BAND?
P-GSM Mobile	[:SOURCE]:RADio:EDGE GSM:FCHannel:BAND MPGSm [:SOURCE]:RADio:EDGE GSM:FCHannel:BAND?
Pattern Repeat Single Cont	[:SOURCE]:RADio:CUSTom:REPeat SINGLE CONTInuous [:SOURCE]:RADio:CUSTom:REPeat?
	[:SOURCE]:RADio:<desired format>:REPeat SINGLE CONTInuous [:SOURCE]:RADio:<desired format>:REPeat?

Key	SCPI Command
Pattern Trigger	[:SOURCE] :RADio:CUSTom:TRIGger[:SOURCE] KEY EXT BUS [:SOURCE] :RADio:CUSTom:TRIGger[:SOURCE]?
	[:SOURCE] :RADio:<desired format>:TRIGger[:SOURCE] KEY EXT BUS [:SOURCE] :RADio:<desired format>:TRIGger[:SOURCE]?
PCS Base	[:SOURCE] :RADio:EDGE GSM:FCHannel:BAND BPCS [:SOURCE] :RADio:EDGE GSM:FCHannel:BAND?
PCS Mobile	[:SOURCE] :RADio:EDGE GSM:FCHannel:BAND MPCS [:SOURCE] :RADio:EDGE GSM:FCHannel:BAND?
PDC Off On	[:SOURCE] :RADio:PDC[:STATE] ON OFF 1 0 [:SOURCE] :RADio:PDC[:STATE]?
Phase Dev	[:SOURCE] :RADio:CUSTom:MODulation:MSK[:PHASe] <val><unit> [:SOURCE] :RADio:CUSTom:MODulation:MSK[:PHASe]?
	[:SOURCE] :RADio:<desired format>:MODulation:MSK[:PHASe] <val><unit> [:SOURCE] :RADio:<desired format>:MODulation:MSK[:PHASe]?
Phase Polarity Normal Invert	[:SOURCE] :RADio:CUSTom:POLarity[:ALL] NORMal INVerted [:SOURCE] :RADio:CUSTom:POLarity[:ALL]?
	[:SOURCE] :RADio:<desired format>:POLarity[:ALL] NORMal INVerted [:SOURCE] :RADio:<desired format>:POLarity[:ALL]?
PHS Off On	[:SOURCE] :RADio:PHS[:STATE] ON OFF 1 0 [:SOURCE] :RADio:PHS[:STATE]?
PN Sequence	[:SOURCE] :RADio:DECT:DATA PN9 PN11 PN15 PN23 FIX4 "<file name>" EXT P4 P8 P16 P32 P64 [:SOURCE] :RADio:DECT:DATA?
PN9	[:SOURCE] :RADio:CUSTom:DATA PN9 [:SOURCE] :RADio:CUSTom:DATA?

Key	SCPI Command
PN9	[:SOURCE]:RADIO:DECT:DATA PN9 [:SOURCE]:RADIO:DECT:DATA?
	[:SOURCE]:RADIO:DECT:PPart:SLOT0 [1] 2 3 4 5 6 7 8 9 10 11:CUSTOM PN9 [:SOURCE]:RADIO:DECT:PPart:SLOT0 [1] 2 3 4 5 6 7 8 9 10 11:CUSTOM?
	[:SOURCE]:RADIO:DECT:PPart:SLOT0 [1] 2 3 4 5 6 7 8 9 10 11:LCAPACITY[:B] PN9 [:SOURCE]:RADIO:DECT:PPart:SLOT0 [1] 2 3 4 5 6 7 8 9 10 11:LCAPACITY[:B]?
	[:SOURCE]:RADIO:DECT:PPart:SLOT0 [1] 2 3 4 5 6 7 8 9 10 11:TRAFFIC[:B] PN9 [:SOURCE]:RADIO:DECT:PPart:SLOT0 [1] 2 3 4 5 6 7 8 9 10 11:TRAFFIC[:B]
	[:SOURCE]:RADIO:DECT:PPart:SLOT0 [1] 2 3 4 5 6 7 8 9 10 11:ZLCAPACITY[:B] PN9 [:SOURCE]:RADIO:DECT:PPart:SLOT0 [1] 2 3 4 5 6 7 8 9 10 11:ZLCAPACITY[:B]?
	[:SOURCE]:RADIO:DECT:PPart:SLOT0 [1] 2 3 4 5 6 7 8 9 10 11:ZTRAFFIC[:B] PN9 [:SOURCE]:RADIO:DECT:PPart:SLOT0 [1] 2 3 4 5 6 7 8 9 10 11:ZTRAFFIC[:B]
	[:SOURCE]:RADIO:DECT:RFPart:SLOT0 [1] 2 3 4 5 6 7 8 9 10 11:CUSTOM PN9 [:SOURCE]:RADIO:DECT:RFPart:SLOT0 [1] 2 3 4 5 6 7 8 9 10 11:CUSTOM?
	[:SOURCE]:RADIO:DECT:RFPart:SLOT0 [1] 2 3 4 5 6 7 8 9 10 11:LCAPACITY[:B] PN9 [:SOURCE]:RADIO:DECT:RFPart:SLOT0 [1] 2 3 4 5 6 7 8 9 10 11:LCAPACITY[:B]?
	[:SOURCE]:RADIO:DECT:RFPart:SLOT0 [1] 2 3 4 5 6 7 8 9 10 11:TRAFFIC[:B] PN9 [:SOURCE]:RADIO:DECT:RFPart:SLOT0 [1] 2 3 4 5 6 7 8 9 10 11:TRAFFIC[:B]?
	[:SOURCE]:RADIO:DECT:RFPart:SLOT0 [1] 2 3 4 5 6 7 8 9 10 11:ZLCAPACITY[:B] PN9 [:SOURCE]:RADIO:DECT:RFPart:SLOT0 [1] 2 3 4 5 6 7 8 9 10 11:ZLCAPACITY[:B]?
	[:SOURCE]:RADIO:DECT:RFPart:SLOT0 [1] 2 3 4 5 6 7 8 9 10 11:ZTRAFFIC[:B] PN9 [:SOURCE]:RADIO:DECT:RFPart:SLOT0 [1] 2 3 4 5 6 7 8 9 10 11:ZTRAFFIC[:B]

Key	SCPI Command
	<pre>[:SOURCE]:RADIO:EDGE:DATA PN9 [:SOURCE]:RADIO:EDGE:DATA? [:SOURCE]:RADIO:EDGE:SLOT0 [1] 2 3 4 5 6 7:CUSTOM PN9 [:SOURCE]:RADIO:EDGE:SLOT0 [1] 2 3 4 5 6 7:CUSTOM? [:SOURCE]:RADIO:EDGE:SLOT0 [1] 2 3 4 5 6 7:NORMAL:ENCRYPTION PN9 [:SOURCE]:RADIO:EDGE:SLOT0 [1] 2 3 4 5 6 7:NORMAL:ENCRYPTION? [:SOURCE]:RADIO:EDGE:SLOT0 [1] 2 3 4 5 6 7:NORMAL:ENCRYPTION: UNCODED PN9 [:SOURCE]:RADIO:EDGE:SLOT0 [1] 2 3 4 5 6 7:NORMAL:ENCRYPTION:UNCODED? [:SOURCE]:RADIO:EDGE:SLOT0 [1] 2 3 4 5 6 7:NORMAL:ENCRYPTION:DLINK:MCS9: DATA PN9 [:SOURCE]:RADIO:EDGE:SLOT0 [1] 2 3 4 5 6 7:NORMAL:ENCRYPTION:DLINK:MCS9: DATA? [:SOURCE]:RADIO:EDGE:SLOT0 [1] 2 3 4 5 6 7:NORMAL:ENCRYPTION:ULINK:MCS9: DATA PN9 [:SOURCE]:RADIO:EDGE:SLOT0 [1] 2 3 4 5 6 7:NORMAL:ENCRYPTION:ULINK:MCS9: DATA? [:SOURCE]:RADIO:EDGE:SLOT0 [1] 2 3 4 5 6 7:NORMAL:ENCRYPTION:DLINK:MCS5: DATA PN9 [:SOURCE]:RADIO:EDGE:SLOT0 [1] 2 3 4 5 6 7:NORMAL:ENCRYPTION:DLINK:MCS5: DATA? [:SOURCE]:RADIO:EDGE:SLOT0 [1] 2 3 4 5 6 7:NORMAL:ENCRYPTION:ULINK:MCS5: DATA PN9[:SOURCE]:RADIO:EDGE:SLOT0 [1] 2 3 4 5 6 7:NORMAL:ENCRYPTION:ULINK:MCS5: DATA?</pre>
PN9 continued	<pre>[:SOURCE]:RADIO:GSM:DATA PN9 [:SOURCE]:RADIO:GSM:DATA? [:SOURCE]:RADIO:GSM:SLOT0 [1] 2 3 4 5 6 7:ACCESS:ENCRYPTION PN9 [:SOURCE]:RADIO:GSM:SLOT0 [1] 2 3 4 5 6 7:ACCESS:ENCRYPTION? [:SOURCE]:RADIO:GSM:SLOT0 [1] 2 3 4 5 6 7:CUSTOM PN9 [:SOURCE]:RADIO:GSM:SLOT0 [1] 2 3 4 5 6 7:CUSTOM? [:SOURCE]:RADIO:GSM:SLOT0 [1] 2 3 4 5 6 7:NORMAL:ENCRYPTION PN9 [:SOURCE]:RADIO:GSM:SLOT0 [1] 2 3 4 5 6 7:NORMAL:ENCRYPTION? [:SOURCE]:RADIO:GSM:SLOT0 [1] 2 3 4 5 6 7:SYNC:ENCRYPTION PN9 [:SOURCE]:RADIO:GSM:SLOT0 [1] 2 3 4 5 6 7:SYNC:ENCRYPTION?</pre>
	<pre>[:SOURCE]:RADIO[:NADC]]:DATA PN9 [:SOURCE]:RADIO[:NADC]? [:SOURCE]:RADIO[:NADC]:SLOT[1] 2 3 4 5 6:DCUSTOM PN9 [:SOURCE]:RADIO[:NADC]:SLOT[1] 2 3 4 5 6:DCUSTOM? [:SOURCE]:RADIO[:NADC]:SLOT[1] 2 3 4 5 6:DTCHANNEL[:DATA] PN9 [:SOURCE]:RADIO[:NADC]:SLOT[1] 2 3 4 5 6:DTCHANNEL[:DATA]? [:SOURCE]:RADIO[:NADC]:SLOT[1] 2 3 4 5 6:UCUSTOM PN9 [:SOURCE]:RADIO[:NADC]:SLOT[1] 2 3 4 5 6:UCUSTOM? [:SOURCE]:RADIO[:NADC]:SLOT[1] 2 3 4 5 6:UTCHANNEL[:DATA] PN9 [:SOURCE]:RADIO[:NADC]:SLOT[1] 2 3 4 5 6:UTCHANNEL[:DATA]?</pre>

Key	SCPI Command
<p>PN9 continued</p>	<pre>[:SOURce]:RADio:PDC:DATA PN9 [:SOURce]:RADio:PDC:DATA? [:SOURce]:RADio:PDC:SLOT0 [1] 2 3 4 5:DCUStom PN9 [:SOURce]:RADio:PDC:SLOT0 [1] 2 3 4 5:DCUStom? [:SOURce]:RADio:PDC:SLOT0 [1] 2 3 4 5:DTCHannel[:TCHannel] PN9 [:SOURce]:RADio:PDC:SLOT0 [1] 2 3 4 5:DTCHannel[:TCHannel]? [:SOURce]:RADio:PDC:SLOT0 [1] 2 3 4 5:DTCHannel[:TCHannel] PN9 [:SOURce]:RADio:PDC:SLOT0 [1] 2 3 4 5:DTCHannel[:TCHannel]? [:SOURce]:RADio:PDC:SLOT0 [1] 2 3 4 5:UCUStom PN9 [:SOURce]:RADio:PDC:SLOT0 [1] 2 3 4 5:UCUStom? [:SOURce]:RADio:PDC:SLOT0 [1] 2 3 4 5:UTCHannel[:TCHannel] PN9 [:SOURce]:RADio:PDC:SLOT0 [1] 2 3 4 5:UTCHannel[:TCHannel]?</pre>
	<pre>[:SOURce]:RADio:PHS:DATA PN9 [:SOURce]:RADio:PHS:DATA? [:SOURce]:RADio:PHS:DLINK:SLOT[1] 2 3 4:CUSTom PN9 [:SOURce]:RADio:PHS:DLINK:SLOT[1] 2 3 4:CUSTom? [:SOURce]:RADio:PHS:DLINK:SLOT[1] 2 3 4:TCHannel[:TCHannel] PN9 [:SOURce]:RADio:PHS:DLINK:SLOT[1] 2 3 4:TCHannel[:TCHannel]? [:SOURce]:RADio:PHS:ULINK:SLOT[1] 2 3 4:CUSTom PN9 [:SOURce]:RADio:PHS:ULINK:SLOT[1] 2 3 4:CUSTom? [:SOURce]:RADio:PHS:ULINK:SLOT[1] 2 3 4:TCHannel[:TCHannel] PN9 [:SOURce]:RADio:PHS:ULINK:SLOT[1] 2 3 4:TCHannel[:TCHannel]?</pre>

Key	SCPI Command
PN9 continued	<pre>[:SOURce]:RADio:TETra:DATA PN9 [:SOURce]:RADio:TETra:DATA? [:SOURce]:RADio:TETra:SLOT[1] 2 3 4:UCUStom PN9 [:SOURce]:RADio:TETra:SLOT[1] 2 3 4:UCUStom? [:SOURce]:RADio:TETra:SLOT[1] 2 3 4:DCUStom PN9 [:SOURce]:RADio:TETra:SLOT[1] 2 3 4:DCUStom? [:SOURce]:RADio:TETra:SLOT[1] 2 3 4:DCNormal[:DATA] PN9 [:SOURce]:RADio:TETra:SLOT[1] 2 3 4:DCNormal[:DATA]? [:SOURce]:RADio:TETra:SLOT[1] 2 3 4:DCSync[:DATA] PN9 [:SOURce]:RADio:TETra:SLOT[1] 2 3 4:DCSync[:DATA]? [:SOURce]:RADio:TETra:SLOT[1] 2 3 4:DDUStom[:DATA] PN9 [:SOURce]:RADio:TETra:SLOT[1] 2 3 4:DDUStom[:DATA]? [:SOURce]:RADio:TETra:SLOT[1] 2 3 4:DDNormal[:DATA] PN9 [:SOURce]:RADio:TETra:SLOT[1] 2 3 4:DDNormal[:DATA]? [:SOURce]:RADio:TETra:SLOT[1] 2 3 4:DDSync[:DATA] PN9 [:SOURce]:RADio:TETra:SLOT[1] 2 3 4:DDSync[:DATA]? [:SOURce]:RADio:TETra:SLOT[1] 2 3 4:UC1[:DATA] PN9 [:SOURce]:RADio:TETra:SLOT[1] 2 3 4:UC1[:DATA]? [:SOURce]:RADio:TETra:SLOT[1] 2 3 4:UC2[:DATA] PN9 [:SOURce]:RADio:TETra:SLOT[1] 2 3 4:UC2[:DATA]? [:SOURce]:RADio:TETra:SLOT[1] 2 3 4:UNormal[:DATA] PN9 [:SOURce]:RADio:TETra:SLOT[1] 2 3 4:UNormal[:DATA]?</pre>
PN9 Mode	<pre>[:SOURce]:RADio:DECT GSM [:NADC] PDC PHS TETra:BUSt:PN9 NORMal QUICK [:SOURce]:RADio:DECT GSM [:NADC] PDC PHS TETra:BUSt:PN9?</pre>
PN11	<pre>[:SOURce]:RADio:CUSTom:DATA PN11 [:SOURce]:RADio:CUSTom:DATA? [:SOURce]:RADio:CUSTom DECT GSM NADC PDC PHS TETra:DATA PN11 [:SOURce]:RADio:CUSTom DECT GSM NADC PDC PHS TETra:DATA?</pre>
PN15	<pre>[:SOURce]:RADio:CUSTom:DATA PN15 [:SOURce]:RADio:CUSTom:DATA?</pre>

Key	SCPI Command
PN15 continued	[:SOURCE]:RADio:DECT:DATA PN15 [:SOURCE]:RADio:DECT:DATA?
	[:SOURCE]:RADio:DECT:PPart:SLOT0 [1] 2 3 4 5 6 7 8 9 10 11:CUSTom PN15 [:SOURCE]:RADio:DECT:PPart:SLOT0 [1] 2 3 4 5 6 7 8 9 10 11:CUSTom?
	[:SOURCE]:RADio:DECT:PPart:SLOT0 [1] 2 3 4 5 6 7 8 9 10 11:LCAPacity [:B] PN15 [:SOURCE]:RADio:DECT:PPart:SLOT0 [1] 2 3 4 5 6 7 8 9 10 11:LCAPacity[:B]?
	[:SOURCE]:RADio:DECT:PPart:SLOT0 [1] 2 3 4 5 6 7 8 9 10 11:TRAFfic[:B] PN15 [:SOURCE]:RADio:DECT:PPart:SLOT0 [1] 2 3 4 5 6 7 8 9 10 11:TRAFfic[:B]?
	[:SOURCE]:RADio:DECT:PPart:SLOT0 [1] 2 3 4 5 6 7 8 9 10 11:ZLCapacity [:B] PN15 [:SOURCE]:RADio:DECT:PPart:SLOT0 [1] 2 3 4 5 6 7 8 9 10 11:ZLCapacity[:B]?
	[:SOURCE]:RADio:DECT:PPart:SLOT0 [1] 2 3 4 5 6 7 8 9 10 11:ZTRAffic[:B] PN15 [:SOURCE]:RADio:DECT:PPart:SLOT0 [1] 2 3 4 5 6 7 8 9 10 11:ZTRAffic[:B]?
	[:SOURCE]:RADio:DECT:RFPart:SLOT0 [1] 2 3 4 5 6 7 8 9 10 11:CUSTom PN15 [:SOURCE]:RADio:DECT:RFPart:SLOT0 [1] 2 3 4 5 6 7 8 9 10 11:CUSTom?
	[:SOURCE]:RADio:DECT:RFPart:SLOT0 [1] 2 3 4 5 6 7 8 9 10 11:LCAPacity [:B] PN15 [:SOURCE]:RADio:DECT:RFPart:SLOT0 [1] 2 3 4 5 6 7 8 9 10 11:LCAPacity[:B]?
	[:SOURCE]:RADio:DECT:RFPart:SLOT0 [1] 2 3 4 5 6 7 8 9 10 11:TRAFfic[:B] PN15 [:SOURCE]:RADio:DECT:RFPart:SLOT0 [1] 2 3 4 5 6 7 8 9 10 11:TRAFfic[:B]?
	[:SOURCE]:RADio:DECT:RFPart:SLOT0 [1] 2 3 4 5 6 7 8 9 10 11:ZLCapacity [:B] PN15 [:SOURCE]:RADio:DECT:RFPart:SLOT0 [1] 2 3 4 5 6 7 8 9 10 11:ZLCapacity[:B]?
	[:SOURCE]:RADio:DECT:RFPart:SLOT0 [1] 2 3 4 5 6 7 8 9 10 11:ZTRAffic [:B] PN15 [:SOURCE]:RADio:DECT:RFPart:SLOT0 [1] 2 3 4 5 6 7 8 9 10 11:ZTRAffic[:B]?

Key	SCPI Command
PN15 continued	<pre>[:SOURCE]:RADIO:EDGE:DATA PN15 [:SOURCE]:RADIO:EDGE:DATA? [:SOURCE]:RADIO:EDGE:SLOT0 [1] 2 3 4 5 6 7:CUSTOM PN15 [:SOURCE]:RADIO:EDGE:SLOT0 [1] 2 3 4 5 6 7:CUSTOM? [:SOURCE]:RADIO:EDGE:SLOT0 [1] 2 3 4 5 6 7:NORMAL:ENCRYPTION PN15 [:SOURCE]:RADIO:EDGE:SLOT0 [1] 2 3 4 5 6 7:NORMAL:ENCRYPTION? [:SOURCE]:RADIO:EDGE:SLOT0 [1] 2 3 4 5 6 7:NORMAL:ENCRYPTION: UNCoded PN15 [:SOURCE]:RADIO:EDGE:SLOT0 [1] 2 3 4 5 6 7:NORMAL:ENCRYPTION:UNCoded? [:SOURCE]:RADIO:EDGE:SLOT0 [1] 2 3 4 5 6 7:NORMAL:ENCRYPTION:DLINK:MCS9 :DATA PN15 [:SOURCE]:RADIO:EDGE:SLOT0 [1] 2 3 4 5 6 7:NORMAL:ENCRYPTION:DLINK:MCS9 :DATA? [:SOURCE]:RADIO:EDGE:SLOT0 [1] 2 3 4 5 6 7:NORMAL:ENCRYPTION:ULINK:MCS9 :DATA PN15 [:SOURCE]:RADIO:EDGE:SLOT0 [1] 2 3 4 5 6 7:NORMAL:ENCRYPTION:ULINK:MCS9 :DATA? [:SOURCE]:RADIO:EDGE:SLOT0 [1] 2 3 4 5 6 7:NORMAL:ENCRYPTION:DLINK:MCS5 :DATA PN15 PN15[:SOURCE]:RADIO:EDGE:SLOT0 [1] 2 3 4 5 6 7:NORMAL:ENCRYPTION:DLINK: MCS5:DATA? [:SOURCE]:RADIO:EDGE:SLOT0 [1] 2 3 4 5 6 7:NORMAL:ENCRYPTION:ULINK:MCS5 :DATA PN15 [:SOURCE]:RADIO:EDGE:SLOT0 [1] 2 3 4 5 6 7:NORMAL:ENCRYPTION:ULINK:MCS5 :DATA?</pre>
	<pre>[:SOURCE]:RADIO:GSM:DATA PN15 [:SOURCE]:RADIO:GSM:DATA? [:SOURCE]:RADIO:GSM:SLOT0 [1] 2 3 4 5 6 7:ACCESS:ENCRYPTION PN15 [:SOURCE]:RADIO:GSM:SLOT0 [1] 2 3 4 5 6 7:ACCESS:ENCRYPTION? [:SOURCE]:RADIO:GSM:SLOT0 [1] 2 3 4 5 6 7:CUSTOM PN15 [:SOURCE]:RADIO:GSM:SLOT0 [1] 2 3 4 5 6 7:CUSTOM? [:SOURCE]:RADIO:GSM:SLOT0 [1] 2 3 4 5 6 7:NORMAL:ENCRYPTION PN15 [:SOURCE]:RADIO:GSM:SLOT0 [1] 2 3 4 5 6 7:NORMAL:ENCRYPTION? [:SOURCE]:RADIO:GSM:SLOT0 [1] 2 3 4 5 6 7:SYNC:ENCRYPTION PN15 [:SOURCE]:RADIO:GSM:SLOT0 [1] 2 3 4 5 6 7:SYNC:ENCRYPTION?</pre>
	<pre>[:SOURCE]:RADIO[:NADC]:DATA PN15 [:SOURCE]:RADIO[:NADC]:DATA? [:SOURCE]:RADIO[:NADC]:SLOT[1] 2 3 4 5 6:DCUSTOM PN15 [:SOURCE]:RADIO[:NADC]:SLOT[1] 2 3 4 5 6:DCUSTOM? [:SOURCE]:RADIO[:NADC]:SLOT[1] 2 3 4 5 6:DTCHANNEL PN15 [:SOURCE]:RADIO[:NADC]:SLOT[1] 2 3 4 5 6:DTCHANNEL? [:SOURCE]:RADIO[:NADC]:SLOT[1] 2 3 4 5 6:UCUSTOM PN15 [:SOURCE]:RADIO[:NADC]:SLOT[1] 2 3 4 5 6:UCUSTOM? [:SOURCE]:RADIO[:NADC]:SLOT[1] 2 3 4 5 6:UTCHANNEL[:DATA] PN15 [:SOURCE]:RADIO[:NADC]:SLOT[1] 2 3 4 5 6:UTCHANNEL[:DATA]?</pre>

Key	SCPI Command
	<pre>[:SOURce]:RADio:PDC:DATA PN15 [:SOURce]:RADio:PDC:DATA? [:SOURce]:RADio:PDC:SLOT0 [1] 2 3 4 5:DCUStom PN15 [:SOURce]:RADio:PDC:SLOT0 [1] 2 3 4 5:DCUStom? [:SOURce]:RADio:PDC:SLOT0 [1] 2 3 4 5:DTCHannel[:TCHannel] PN15 [:SOURce]:RADio:PDC:SLOT0 [1] 2 3 4 5:DTCHannel[:TCHannel]? [:SOURce]:RADio:PDC:SLOT0 [1] 2 3 4 5:UCUStom PN15 [:SOURce]:RADio:PDC:SLOT0 [1] 2 3 4 5:UCUStom? [:SOURce]:RADio:PDC:SLOT0 [1] 2 3 4 5:UTCHannel[:TCHannel] PN15 [:SOURce]:RADio:PDC:SLOT0 [1] 2 3 4 5:UTCHannel[:TCHannel]?</pre>
	<pre>[:SOURce]:RADio:PHS:DATA PN15 [:SOURce]:RADio:PHS:DATA? [:SOURce]:RADio:PHS:DLINK:SLOT[1] 2 3 4:CUSTom PN15 [:SOURce]:RADio:PHS:DLINK:SLOT[1] 2 3 4:CUSTom? [:SOURce]:RADio:PHS:DLINK:SLOT[1] 2 3 4:TCHannel[:TCHannel] PN15 [:SOURce]:RADio:PHS:DLINK:SLOT[1] 2 3 4:TCHannel[:TCHannel]? [:SOURce]:RADio:PHS:ULINK:SLOT[1] 2 3 4:CUSTom PN15 [:SOURce]:RADio:PHS:ULINK:SLOT[1] 2 3 4:CUSTom? [:SOURce]:RADio:PHS:ULINK:SLOT[1] 2 3 4:TCHannel[:TCHannel] PN15 [:SOURce]:RADio:PHS:ULINK:SLOT[1] 2 3 4:TCHannel[:TCHannel]?</pre>
<p>PN15 continued</p>	<pre>[:SOURce]:RADio:TETRa:DATA PN15 [:SOURce]:RADio:TETRa:DATA? [:SOURce]:RADio:TETRa:SLOT[1] 2 3 4:UCUStom PN15 [:SOURce]:RADio:TETRa:SLOT[1] 2 3 4:UCUStom? [:SOURce]:RADio:TETRa:SLOT[1] 2 3 4:DCCustom PN15 [:SOURce]:RADio:TETRa:SLOT[1] 2 3 4:DCCustom? [:SOURce]:RADio:TETRa:SLOT[1] 2 3 4:DCNormal[:DATA] PN15 [:SOURce]:RADio:TETRa:SLOT[1] 2 3 4:DCNormal[:DATA]? [:SOURce]:RADio:TETRa:SLOT[1] 2 3 4:DCSync[:DATA] PN15 [:SOURce]:RADio:TETRa:SLOT[1] 2 3 4:DCSync[:DATA]? [:SOURce]:RADio:TETRa:SLOT[1] 2 3 4:DDCustom[:DATA] PN15 [:SOURce]:RADio:TETRa:SLOT[1] 2 3 4:DDCustom[:DATA]? [:SOURce]:RADio:TETRa:SLOT[1] 2 3 4:DDNormal[:DATA] PN15 [:SOURce]:RADio:TETRa:SLOT[1] 2 3 4:DDNormal[:DATA]? [:SOURce]:RADio:TETRa:SLOT[1] 2 3 4:DDSync[:DATA] PN15 [:SOURce]:RADio:TETRa:SLOT[1] 2 3 4:DDSync[:DATA]? [:SOURce]:RADio:TETRa:SLOT[1] 2 3 4:UC1[:DATA] PN15 [:SOURce]:RADio:TETRa:SLOT[1] 2 3 4:UC1[:DATA]? [:SOURce]:RADio:TETRa:SLOT[1] 2 3 4:UC2[:DATA] PN15 [:SOURce]:RADio:TETRa:SLOT[1] 2 3 4:UC2[:DATA]? [:SOURce]:RADio:TETRa:SLOT[1] 2 3 4:UNORmal[:DATA] PN15 [:SOURce]:RADio:TETRa:SLOT[1] 2 3 4:UNORmal[:DATA]?</pre>

Key	SCPI Command
PN20	[:SOURce]:RADio:CUSTom:DATA PN20 [:SOURce]:RADio:CUSTom:DATA?
	[:SOURce]:RADio:DECT GSM [:NADC] TETra PDC PHS:DATA PN20 [:SOURce]:RADio:DECT GSM [:NADC] TETra PDC PHS:DATA?
PN23	[:SOURce]:RADio:CUSTom:DATA PN23 [:SOURce]:RADio:CUSTom:DATA?
	[:SOURce]:RADio:DECT GSM [NADC] TETra PDC PHS:DATA PN23 [:SOURce]:RADio:DECT GSM [NADC] TETra PDC PHS:DATA?
PN Sequence	[:SOURce]:RADio:DECT:DATA PN9 PN11 PN15 PN23 FIX4 "<file name>" EXT P4 P8 P16 P32 P64 [:SOURce]:RADio:DECT:DATA?
Predefined Mode	[:SOURce]:RADio:CUSTom:STANdard:SElect NONE AC4Fm ACQpsk BLUetooth CDPD [:SOURce]:RADio:CUSTom:STANdard:SElect?
PSID	[:SOURce]:RADio:PHS:DLINK:SLOT[1] 2 3 4:SCHannel:PSID <bit pattern> [:SOURce]:RADio:PHS:DLINK:SLOT[1] 2 3 4:SCHannel:PSID?
	[:SOURce]:RADio:PHS:ULINK:SLOT[1] 2 3 4:SCHannel:PSID <bit pattern> [:SOURce]:RADio:PHS:ULINK:SLOT[1] 2 3 4:SCHannel:PSID?
QPSK	[:SOURce]:RADio:CUSTom:MODulation[:TYPE] QPSK [:SOURce]:RADio:CUSTom:MODulation[:TYPE]?
	[:SOURce]:RADio:<desired format>:MODulation[:TYPE] QPSK [:SOURce]:RADio:<desired format>:MODulation[:TYPE]?
R-GSM Base	[:SOURce]:RADio:EDGE GSM:FCHannel:BAND BRGSm [:SOURce]:RADio:EDGE GSM:FCHannel:BAND?
R-GSM Mobile	[:SOURce]:RADio:EDGE GSM:FCHannel:BAND MRGSm [:SOURce]:RADio:EDGE GSM:FCHannel:BAND?
Rate Full Half	[:SOURce]:RADio[:NADC] PDC:FRATe FULL HALF [:SOURce]:RADio[:NADC] PDC:FRATe?
Recall Secondary Frame State	[:SOURce]:RADio:<desired format>:SECondary:RECall
Rectangle	[:SOURce]:RADio:CUSTom:FILTer RECTangle [:SOURce]:RADio:CUSTom:FILTer?
	[:SOURce]:RADio:<desired format>:FILTer RECTangle [:SOURce]:RADio:<desired format>:FILTer?
Rename	[:MEMory]:MOVE <src_file>,<dest_file> [:MMEORY]:MOVE <src_file>,<dest_file>
Reset & Run	[:SOURce]:RADio:<desired format>:TRIGger[:SOURce]:EXTErnal[:TYPE] RESet [:SOURce]:RADio:<desired format>:TRIGger[:SOURce]:EXTErnal[:TYPE]?
Restore Custom Factory Default	[:SOURce]:RADio:Custom:Default

Key	SCPI Command
Restore DECT Factory Default	[:SOURCE]:RADio:DECT:Default
Restore EDGE Factory Default	[:SOURCE]:RADio:EDGE:Default
Restore GSM Factory Default	[:SOURCE]:RADio:GSM:Default
Restore NADC Factory Default	[:SOURCE]:RADio[:NADC]:Default
Restore PDC Factory Default	[:SOURCE]:RADio:PDC:Default
Restore PHS Factory Default	[:SOURCE]:RADio:PHS:Default
Restore TETRA Factory Default	[:SOURCE]:RADio:TETRA:Default
Rise Delay	[:SOURCE]:RADio:CUSTom:BURSt:SHAPE:RDElay <value> [:SOURCE]:RADio:CUSTom:BURSt:SHAPE:RDElay? [:SOURCE]:RADio:CUSTom:BURSt:SHAPE:RISE:DElay <value> [:SOURCE]:RADio:CUSTom:BURSt:SHAPE:RISE:DElay?
	[:SOURCE]:RADio:<desired format>:BURSt:SHAPE:RISE:DElay <value> [:SOURCE]:RADio:<desired format>:BURSt:SHAPE:RISE:DElay? [:SOURCE]:RADio:<desired format>:BURSt:SHAPE:RDElay <value> [:SOURCE]:RADio:<desired format>:BURSt:SHAPE:RDElay?
Rise Time	[:SOURCE]:RADio:CUSTom:BURSt:SHAPE:RISE:TIME <value> [:SOURCE]:RADio:CUSTom:BURSt:SHAPE:RISE:TIME? [:SOURCE]:RADio:CUSTom:BURSt:SHAPE:RTIME <value> [:SOURCE]:RADio:CUSTom:BURSt:SHAPE:RTIME?
	[:SOURCE]:RADio:<desired format>:BURSt:SHAPE:RISE:TIME <value> [:SOURCE]:RADio:<desired format>:BURSt:SHAPE:RISE:TIME? [:SOURCE]:RADio:<desired format>:BURSt:SHAPE:RTIME <value> [:SOURCE]:RADio:<desired format>:BURSt:SHAPE:RTIME?
Root Nyquist	[:SOURCE]:RADio:CUSTom:FILTer RNYquist [:SOURCE]:RADio:CUSTom:FILTer?
	[:SOURCE]:RADio:<desired format>:FILTer RNYquist [:SOURCE]:RADio:<desired format>:FILTer?

Key	SCPI Command
S	<pre>[:SOURce]:RADio:DECT:PPart:SLOT0 [1] 2 3 4 5 6 7 8 9 10 11:LCAPacity: S <16-bit value> [:SOURce]:RADio:DECT:PPart:SLOT0 [1] 2 3 4 5 6 7 8 9 10 11:LCAPacity:S? [:SOURce]:RADio:DECT:PPart:SLOT0 [1] 2 3 4 5 6 7 8 9 10 11:TRAFficL: S <16-bit value> [:SOURce]:RADio:DECT:PPart:SLOT0 [1] 2 3 4 5 6 7 8 9 10 11:TRAFfic:S? [:SOURce]:RADio:DECT:PPart:SLOT0 [1] 2 3 4 5 6 7 8 9 10 11:ZLCapacity: S <16-bit value> [:SOURce]:RADio:DECT:PPart:SLOT0 [1] 2 3 4 5 6 7 8 9 10 11:ZLCapacity:S? [:SOURce]:RADio:DECT:PPart:SLOT0 [1] 2 3 4 5 6 7 8 9 10 11:ZTRaffic: S <16-bit value> [:SOURce]:RADio:DECT:PPart:SLOT0 [1] 2 3 4 5 6 7 8 9 10 11:ZTRaffic:S? [:SOURce]:RADio:DECT:RFPart:SLOT0 [1] 2 3 4 5 6 7 8 9 10 11:DUMM[1]: S <16-bit value> [:SOURce]:RADio:DECT:RFPart:SLOT0 [1] 2 3 4 5 6 7 8 9 10 11:DUMM[1]:S? [:SOURce]:RADio:DECT:RFPart:SLOT0 [1] 2 3 4 5 6 7 8 9 10 11:DUMM2: S <16-bit value> [:SOURce]:RADio:DECT:RFPart:SLOT0 [1] 2 3 4 5 6 7 8 9 10 11:DUMM2:S? [:SOURce]:RADio:DECT:RFPart:SLOT0 [1] 2 3 4 5 6 7 8 9 10 11:LCAPacity: S <16-bit value> [:SOURce]:RADio:DECT:RFPart:SLOT0 [1] 2 3 4 5 6 7 8 9 10 11:LCAPacity:S? [:SOURce]:RADio:DECT:RFPart:SLOT0 [1] 2 3 4 5 6 7 8 9 10 11:TRAFfic: S <16-bit value> [:SOURce]:RADio:DECT:RFPart:SLOT0 [1] 2 3 4 5 6 7 8 9 10 11:TRAFfic:S? [:SOURce]:RADio:DECT:RFPart:SLOT0 [1] 2 3 4 5 6 7 8 9 10 11:ZLCapacity: S <16-bit value> [:SOURce]:RADio:DECT:RFPart:SLOT0 [1] 2 3 4 5 6 7 8 9 10 11:ZLCapacity:S? [:SOURce]:RADio:DECT:RFPart:SLOT0 [1] 2 3 4 5 6 7 8 9 10 11:ZTRaffic: S <16-bit value> [:SOURce]:RADio:DECT:RFPart:SLOT0 [1] 2 3 4 5 6 7 8 9 10 11:ZTRaffic:S?</pre>
	<pre>[:SOURce]:RADio:GSM:SLOT0 [1] 2 3 4 5 6 7:NORMAl:STeAl <1 bit pattern> [:SOURce]:RADio:GSM:SLOT0 [1] 2 3 4 5 6 7:NORMAl:STeAl?</pre>
SA	<pre>[:SOURce]:RADio:PHS:DLINK:SLOT[1] 2 3 4:TCHannel:SACChannel <bit pattern> [:SOURce]:RADio:PHS:DLINK:SLOT[1] 2 3 4:TCHannel:SACChannel? [:SOURce]:RADio:PHS:ULINK:SLOT[1] 2 3 4:TCHannel:SACChannel <bit pattern> [:SOURce]:RADio:PHS:ULINK:SLOT[1] 2 3 4:TCHannel:SACChannel?</pre>

Key	SCPI Command
SACCH	<pre>[:SOURce]:RADio:PDC:SLOT0 [1] 2 3 4 5:DTCHannel:SACChannel <bit-pattern> [:SOURce]:RADio:PDC:SLOT0 [1] 2 3 4 5:DTCHannel:SACChannel? [:SOURce]:RADio:PDC:SLOT0 [1] 2 3 4 5:UTCHannel:SACChannel <bit-pattern> [:SOURce]:RADio:PDC:SLOT0 [1] 2 3 4 5:UTCHannel:SACChannel? [:SOURce]:RADio:PDC:SLOT0 [1] 2 3 4 5:UVOX:SACChannel <bit-pattern> [:SOURce]:RADio:PDC:SLOT0 [1] 2 3 4 5:UVOX:SACChannel? [:SOURce]:RADio[:NADC]:SLOT[1] 2 3 4 5 6:DTCHannel:SACChanel <bit-pattern> [:SOURce]:RADio[:NADC]:SLOT[1] 2 3 4 5 6:DTCHannel:SACChanel? [:SOURce]:RADio[:NADC]:SLOT[1] 2 3 4 5 6:UTCHannel:SACChanel <bit-pattern> [:SOURce]:RADio[:NADC]:SLOT[1] 2 3 4 5 6:UTCHannel:SACChanel?</pre>
Save Secondary Frame State	<pre>[:SOURce]:RADio:<desired format>:SECOndary:SAVE</pre>
Scramble Off On	<pre>[:SOURce]:RADio:PHS TETra:BURSt:SCRamble[:STATE] ON OFF 1 0 [:SOURce]:RADio:PHS TETra:BURSt:SCRamble[:STATE]?</pre>
Scramble Seed	<pre>[:SOURce]:RADio:PHS:BURSt:SCRamble:SEED <16-bit val> [:SOURce]:RADio:PHS TETra:BURSt:SCRamble:SEED? [:SOURce]:RADio:TETra:BURSt:SCRamble:SEED <32-bit val> [:SOURce]:RADio:TETra:BURSt:SCRamble:SEED?</pre>
Secondary Frame Off On	<pre>[:SOURce]:RADio:<desired format>:SECOndary[:STATE] ON OFF 1 0 [:SOURce]:RADio:<desired format>:SECOndary[:STATE]?</pre>
Secondary Frame Trigger	<pre>[:SOURce]:RADio:<desired format>:SECOndary:TRIGger[:SOURce] KEY EXT BUS [:SOURce]:RADio:<desired format>:SECOndary:TRIGger[:SOURce]?</pre>
Select	<pre>[:SOURce]:RADio:CUSTom:FILTer RNYQuist NYQuist GAUSSian RECTangle "<file name>" [:SOURce]:RADio:CUSTom:FILTer? [:SOURce]:RADio:<desired format>:FILTer RNYQuist NYQuist GAUSSian RECTangle "<file name>" [:SOURce]:RADio:<desired format>:FILTer?</pre>

Key	SCPI Command
Select File	<pre>[:SOURce]:RADio:Custom:DATA "<file name>" [:SOURce]:RADio:Custom:DATA?</pre>
	<pre>[:SOURce]:RADio:DECT:DATA "<file name>" [:SOURce]:RADio:DECT:DATA? [:SOURce]:RADio:DECT:PPart:SLOT0 [1] 2 3 4 5 6 7 8 9 10 11: CUSTom "<file name>" [:SOURce]:RADio:DECT:PPart:SLOT0 [1] 2 3 4 5 6 7 8 9 10 11:CUSTom? [:SOURce]:RADio:DECT:PPart:SLOT0 [1] 2 3 4 5 6 7 8 9 10 11:LCAPacity[:B] "<file name>" [:SOURce]:RADio:DECT:PPart:SLOT0 [1] 2 3 4 5 6 7 8 9 10 11:LCAPacity[:B]? [:SOURce]:RADio:DECT:PPart:SLOT0 [1] 2 3 4 5 6 7 8 9 10 11:TRAFFic[:B] "<file name>" [:SOURce]:RADio:DECT:PPart:SLOT0 [1] 2 3 4 5 6 7 8 9 10 11:TRAFFic[:B]? [:SOURce]:RADio:DECT:PPart:SLOT0 [1] 2 3 4 5 6 7 8 9 10 11:ZLCAPacity[:B] "<file name>" [:SOURce]:RADio:DECT:PPart:SLOT0 [1] 2 3 4 5 6 7 8 9 10 11:ZLCAPacity[:B]? [:SOURce]:RADio:DECT:PPart:SLOT0 [1] 2 3 4 5 6 7 8 9 10 11:ZTRAFFic[:B] "<file name>" [:SOURce]:RADio:DECT:PPart:SLOT0 [1] 2 3 4 5 6 7 8 9 10 11:ZTRAFFic[:B]? [:SOURce]:RADio:DECT:RFPart:SLOT0 [1] 2 3 4 5 6 7 8 9 10 11: CUSTom "<file name>" [:SOURce]:RADio:DECT:RFPart:SLOT0 [1] 2 3 4 5 6 7 8 9 10 11:CUSTom? [:SOURce]:RADio:DECT:RFPart:SLOT0 [1] 2 3 4 5 6 7 8 9 10 11:LCAPacity[:B] "<file name>" [:SOURce]:RADio:DECT:RFPart:SLOT0 [1] 2 3 4 5 6 7 8 9 10 11:LCAPacity[:B]? [:SOURce]:RADio:DECT:RFPart:SLOT0 [1] 2 3 4 5 6 7 8 9 10 11:TRAFFic[:B] "<file name>" [:SOURce]:RADio:DECT:RFPart:SLOT0 [1] 2 3 4 5 6 7 8 9 10 11:TRAFFic[:B]? [:SOURce]:RADio:DECT:RFPart:SLOT0 [1] 2 3 4 5 6 7 8 9 10 11:ZLCAPacity[:B] "<file name>" [:SOURce]:RADio:DECT:RFPart:SLOT0 [1] 2 3 4 5 6 7 8 9 10 11:ZLCAPacity[:B]? [:SOURce]:RADio:DECT:RFPart:SLOT0 [1] 2 3 4 5 6 7 8 9 10 11:ZTRAFFic[:B] "<file name>" [:SOURce]:RADio:DECT:RFPart:SLOT0 [1] 2 3 4 5 6 7 8 9 10 11:ZTRAFFic[:B]?</pre>
	<pre>[:SOURce]:RADio:EDGE:DATA "<file name>" [:SOURce]:RADio:EDGE:DATA? [:SOURce]:RADio:EDGE:SLOT0 [1] 2 3 4 5 6 7:CUSTom "<file name>" [:SOURce]:RADio:EDGE:SLOT0 [1] 2 3 4 5 6 7:CUSTom? [:SOURce]:RADio:EDGE:SLOT0 [1] 2 3 4 5 6 7:NORMal:ENCRyption "<file name>" [:SOURce]:RADio:EDGE:SLOT0 [1] 2 3 4 5 6 7:NORMal:ENCRyption? [:SOURce]:RADio:EDGE:BURSt:SHAPE[:TYPE] "<file name>" [:SOURce]:RADio:EDGE:BURSt:SHAPE[:TYPE]?</pre>

Key	SCPI Command
	<pre>[:SOURce]:RADio:GSM:DATA "<file name>" [:SOURce]:RADio:GSM:DATA? [:SOURce]:RADio:GSM:SLOT0 [1] 2 3 4 5 6 7:ACCEss:ENCRyption "<file name>" [:SOURce]:RADio:GSM:SLOT0 [1] 2 3 4 5 6 7:ACCEss:ENCRyption? [:SOURce]:RADio:GSM:SLOT0 [1] 2 3 4 5 6 7:CUSTom "<file name>" [:SOURce]:RADio:GSM:SLOT0 [1] 2 3 4 5 6 7:CUSTom? [:SOURce]:RADio:GSM:SLOT0 [1] 2 3 4 5 6 7:NORMAl:ENCRyption "<file name>" [:SOURce]:RADio:GSM:SLOT0 [1] 2 3 4 5 6 7:NORMAl:ENCRyption? [:SOURce]:RADio:GSM:SLOT0 [1] 2 3 4 5 6 7:SYNC:ENCRyption "<file name>" [:SOURce]:RADio:GSM:SLOT0 [1] 2 3 4 5 6 7:SYNC:ENCRyption?</pre>
	<pre>[:SOURce]:RADio[:NADC]:DATA "<file name>" [:SOURce]:RADio[:NADC]:DATA? [:SOURce]:RADio[:NADC]:SLOT[1] 2 3 4 5 6:DCUStom "<file name>" [:SOURce]:RADio[:NADC]:SLOT[1] 2 3 4 5 6:DCUStom? [:SOURce]:RADio[:NADC]:SLOT[1] 2 3 4 5 6:DTCHannel "<file name>" [:SOURce]:RADio[:NADC]:SLOT[1] 2 3 4 5 6:DTCHannel? [:SOURce]:RADio[:NADC]:SLOT[1] 2 3 4 5 6:UCUStom "<file name>" [:SOURce]:RADio[:NADC]:SLOT[1] 2 3 4 5 6:UCUStom? [:SOURce]:RADio[:NADC]:SLOT[1] 2 3 4 5 6:UTCHannel[:DATA] "<file name>" [:SOURce]:RADio[:NADC]:SLOT[1] 2 3 4 5 6:UTCHannel[:DATA]?</pre>
<p>Select File continued</p>	<pre>[:SOURce]:RADio:PDC:DATA "<file name>" [:SOURce]:RADio:PDC:DATA? [:SOURce]:RADio:PDC:SLOT0 [1] 2 3 4 5:DCUStom "<file name>" [:SOURce]:RADio:PDC:SLOT0 [1] 2 3 4 5:DCUStom? [:SOURce]:RADio:PDC:SLOT0 [1] 2 3 4 5:DTCHannel[:TCHannel] "<file name>" [:SOURce]:RADio:PDC:SLOT0 [1] 2 3 4 5:DTCHannel[:TCHannel]? [:SOURce]:RADio:PDC:SLOT0 [1] 2 3 4 5:DTCHannel[:TCHannel] "<file name>" [:SOURce]:RADio:PDC:SLOT0 [1] 2 3 4 5:DTCHannel[:TCHannel]? [:SOURce]:RADio:PDC:SLOT0 [1] 2 3 4 5:UCUStom "<file name>" [:SOURce]:RADio:PDC:SLOT0 [1] 2 3 4 5:UCUStom? [:SOURce]:RADio:PDC:SLOT0 [1] 2 3 4 5:UTCHannel[:TCHannel] "<file name>" [:SOURce]:RADio:PDC:SLOT0 [1] 2 3 4 5:UTCHannel[:TCHannel]?</pre>
	<pre>[:SOURce]:RADio:PHS:DATA "<file name>" [:SOURce]:RADio:PHS:DATA? [:SOURce]:RADio:PHS:DLINK:SLOT[1] 2 3 4:CUSTom "<file name>" [:SOURce]:RADio:PHS:DLINK:SLOT[1] 2 3 4:CUSTom? [:SOURce]:RADio:PHS:DLINK:SLOT[1] 2 3 4:CUSTom "<file name>" [:SOURce]:RADio:PHS:DLINK:SLOT[1] 2 3 4:CUSTom? [:SOURce]:RADio:PHS:ULINK:SLOT[1] 2 3 4:CUSTom "<file name>" [:SOURce]:RADio:PHS:ULINK:SLOT[1] 2 3 4:CUSTom? [:SOURce]:RADio:PHS:ULINK:SLOT[1] 2 3 4:TCHannel[:TCHannel] "<file name>" [:SOURce]:RADio:PHS:ULINK:SLOT[1] 2 3 4:TCHannel[:TCHannel]?</pre>

Key	SCPI Command
Select File continued	<pre>[:SOURce]:RADio:TETRa:DATA "<file name>" [:SOURce]:RADio:TETRa:DATA? [:SOURce]:RADio:TETRa:SLOT[1] 2 3 4:UCUStom "<file name>" [:SOURce]:RADio:TETRa:SLOT[1] 2 3 4:UCUStom? [:SOURce]:RADio:TETRa:SLOT[1] 2 3 4:DCCustom "<file name>" [:SOURce]:RADio:TETRa:SLOT[1] 2 3 4:DCCustom? [:SOURce]:RADio:TETRa:SLOT[1] 2 3 4:DCNormal[:DATA] "<file name>" [:SOURce]:RADio:TETRa:SLOT[1] 2 3 4:DCNormal[:DATA]? [:SOURce]:RADio:TETRa:SLOT[1] 2 3 4:DCSync[:DATA] "<file name>" [:SOURce]:RADio:TETRa:SLOT[1] 2 3 4:DCSync[:DATA]? [:SOURce]:RADio:TETRa:SLOT[1] 2 3 4:DDCustom[:DATA] "<file name>" [:SOURce]:RADio:TETRa:SLOT[1] 2 3 4:DDCustom[:DATA]? [:SOURce]:RADio:TETRa:SLOT[1] 2 3 4:DDNormal[:DATA] "<file name>" [:SOURce]:RADio:TETRa:SLOT[1] 2 3 4:DDNormal[:DATA]? [:SOURce]:RADio:TETRa:SLOT[1] 2 3 4:DDSync[:DATA] "<file name>" [:SOURce]:RADio:TETRa:SLOT[1] 2 3 4:DDSync[:DATA]? [:SOURce]:RADio:TETRa:SLOT[1] 2 3 4:UC1[:DATA] "<file name>" [:SOURce]:RADio:TETRa:SLOT[1] 2 3 4:UC1[:DATA]? [:SOURce]:RADio:TETRa:SLOT[1] 2 3 4:UC2[:DATA] "<file name>" [:SOURce]:RADio:TETRa:SLOT[1] 2 3 4:UC2[:DATA]? [:SOURce]:RADio:TETRa:SLOT[1] 2 3 4:UNORmal[:DATA] "<file name>" [:SOURce]:RADio:TETRa:SLOT[1] 2 3 4:UNORmal[:DATA]?</pre>
Sine	<pre>[:SOURce]:RADio:<desired format>:BURSt:SHAPE[:TYPE] SINE [:SOURce]:RADio:<desired format>:BURSt:SHAPE[:TYPE]?</pre>
Single Shot	<pre>[:SOURce]:RADio:<desired format>:TRIGger[:SOURce]:EXTErnal[:TYPE] SINGLE [:SOURce]:RADio:<desired format>:TRIGger[:SOURce]:EXTErnal[:TYPE]?</pre>
SS	<pre>[:SOURce]:RADio:GSM:SLOT0 [1] 2 3 4 5 6 7:ACCess:SSEquence <bit_pattern> [:SOURce]:RADio:GSM:SLOT0 [1] 2 3 4 5 6 7:ACCess:SSEquence?</pre>
SSB	<pre>[:SOURce]:RADio:TETRa:SLOT[1] 2 3 4:DCSync:SSB <120-bit value> [:SOURce]:RADio:TETRa:SLOT[1] 2 3 4:DCSync:SSB? [:SOURce]:RADio:TETRa:SLOT[1] 2 3 4:DDSync:SSB <120-bit value> [:SOURce]:RADio:TETRa:SLOT[1] 2 3 4:DDSync:SSB?</pre>
Standard	<pre>[:SOURce]:RADio:DECT:FCHannel:BAND STANdard [:SOURce]:RADio:DECT:FCHannel:BAND?</pre>
STS	<pre>[:SOURce]:RADio:TETRa:SLOT[1] 2 3 4:DCSync:STS <38-bit value> [:SOURce]:RADio:TETRa:SLOT[1] 2 3 4:DCSync:STS? [:SOURce]:RADio:TETRa:SLOT[1] 2 3 4:DDSync:STS <38-bit value> [:SOURce]:RADio:TETRa:SLOT[1] 2 3 4:DDSync:STS?</pre>

Key	SCPI Command
SW	[:SOURCE]:RADIO:PDC:SLOT0 [1] 2 3 4 5:DTCHannel:SWORd <bit pattern> [:SOURCE]:RADIO:PDC:SLOT0 [1] 2 3 4 5:DTCHannel:SWORd?
	[:SOURCE]:RADIO:PDC:SLOT0 [1] 2 3 4 5:UTCHannel:SWORd <bit pattern> [:SOURCE]:RADIO:PDC:SLOT0 [1] 2 3 4 5:UTCHannel:SWORd?
	[:SOURCE]:RADIO:PDC:SLOT0 [1] 2 3 4 5:UVOX:SWORd <bit pattern> [:SOURCE]:RADIO:PDC:SLOT0 [1] 2 3 4 5:UVOX:SWORd?
Symbol Rate	[:SOURCE]:RADIO:CUSTom:BRATe <value> [:SOURCE]:RADIO:CUSTom:BRATe?
	[:SOURCE]:RADIO:CUSTom:SRATe <value> [:SOURCE]:RADIO:CUSTom:SRATe?
	[:SOURCE]:RADIO:DECT GSM [:NADC] PDC PHS TETRA:BRATe <value> [:SOURCE]:RADIO:DECT GSM [:NADC] PDC PHS TETRA:BRATe? [:SOURCE]:RADIO:<desired format>:SRATe <value> [:SOURCE]:RADIO:<desired format>:SRATe?
Symbol Sync Out	[:SOURCE]:RADIO:EDGE:BNCMux:SSOut [:SOURCE]:RADIO:EDGE:BNCMux:SSOut?
SYNC	[:SOURCE]:RADIO[:NADC]:SLOT[1] 2 3 4 5 6:DTCHannel:SWORd <bit pattern> [:SOURCE]:RADIO[:NADC]:SLOT[1] 2 3 4 5 6:DTCHannel:SWORd?
	[:SOURCE]:RADIO[:NADC]:SLOT[1] 2 3 4 5 6:UTCHannel:SWORd <bit pattern> [:SOURCE]:RADIO[:NADC]:SLOT[1] 2 3 4 5 6:UTCHannel:SWORd?
	[:SOURCE]:RADIO:PHS:DLINK:SLOT[1] 2 3 4[:TYPE] SYNC [:SOURCE]:RADIO:PHS:DLINK:SLOT[1] 2 3 4[:TYPE]? [:SOURCE]:RADIO:PHS:ULINK:SLOT[1] 2 3 4[:TYPE] SYNC [:SOURCE]:RADIO:PHS:ULINK:SLOT[1] 2 3 4[:TYPE]?
Sync	[:SOURCE]:RADIO:GSM:SLOT0 [1] 2 3 4 5 6 7[:TYPE] SYNC [:SOURCE]:RADIO:GSM:SLOT0 [1] 2 3 4 5 6 7[:TYPE]?
Sync Out	[:SOURCE]:RADIO:CUSTom:SOUT FRAME SLOT ALL [:SOURCE]:RADIO:CUSTom:SOUT?
	[:SOURCE]:RADIO:DECT NADC:SOUT FRAME SLOT ALL [:SOURCE]:RADIO:DECT NADC:SOUT?
Sync Out Offset	[:SOURCE]:RADIO:CUSTom:SOUT OFFSet <value> [:SOURCE]:RADIO:CUSTom:SOUT:OFFSet?
	[:SOURCE]:RADIO:<desired format>:SOUT:OFFSet <value> [:SOURCE]:RADIO:<desired format>:SOUT:OFFSet?
T1, T2	[:SOURCE]:RADIO:EDGE:SLOT0 [1] 2 3 4 5 6 7:NORMAl:T1 <9 bit pattern> [:SOURCE]:RADIO:EDGE:SLOT0 [1] 2 3 4 5 6 7:NORMAl:T1? [:SOURCE]:RADIO:EDGE:SLOT0 [1] 2 3 4 5 6 7:NORMAl:T2 <9 bit pattern> [:SOURCE]:RADIO:EDGE:SLOT0 [1] 2 3 4 5 6 7:NORMAl:T2?

Key	SCPI Command
TCH	<pre>[:SOURce]:RADio:PDC:SLOT0 [1] 2 3 4 5:DTCHannel[:TCHannel] PN9 PN15 FIX4 "<file name>" EXT P4 P8 P16 P32 P64 [:SOURce]:RADio:PDC:SLOT0 [1] 2 3 4 5:DTCHannel[:TCHannel]?</pre>
	<pre>[:SOURce]:RADio:PDC:SLOT0 [1] 2 3 4 5:UTCHannel[:TCHannel] PN9 PN15 FIX4 "<file name>" EXT P4 P8 P16 P32 P64? [:SOURce]:RADio:PDC:SLOT0 [1] 2 3 4 5:UTCHannel[:TCHannel]?</pre>
	<pre>[:SOURce]:RADio:PHS:DLINK:SLOT[1] 2 3 4:TCHannel[:TCHannel] PN9 PN15 FIX4 "<file name>" EXT P4 P8 P16 P32 P64 [:SOURce]:RADio:PHS:DLINK:SLOT[1] 2 3 4:TCHannel[:TCHannel]?</pre> <pre>[:SOURce]:RADio:PHS:DLINK:SLOT[1] 2 3 4[:TYPE] TCH [:SOURce]:RADio:PHS:DLINK:SLOT[1] 2 3 4[:TYPE]?</pre> <pre>[:SOURce]:RADio:PHS:ULINK:SLOT[1] 2 3 4[:TYPE] TCH [:SOURce]:RADio:PHS:ULINK:SLOT[1] 2 3 4[:TYPE]?</pre>
TCH All	<pre>[:SOURce]:RADio:PHS:DLINK:SLOT[1] 2 3 4[:TYPE] TCH_ALL [:SOURce]:RADio:PHS:DLINK:SLOT[1] 2 3 4[:TYPE]?</pre> <pre>[:SOURce]:RADio:PHS:ULINK:SLOT[1] 2 3 4[:TYPE] TCH_ALL [:SOURce]:RADio:PHS:ULINK:SLOT[1] 2 3 4[:TYPE]?</pre>
TCH/FS	<pre>[:SOURce]:RADio:GSM:SLOT0 [1] 2 3 4 5 6 7:NORMal:ENCRyption:TCH:FS:DATA :SOURce]:RADio:GSM:SLOT0 [1] 2 3 4 5 6 7:NORMal:ENCRyption:TCH:FS:DATA?</pre>
TETRA Off On	<pre>[:SOURce]:RADio:TETra[:STaTe] ON OFF 1 0 [:SOURce]:RADio:TETra[:STaTe]?</pre>
Timeslot Ampl Main Delta	<pre>[:SOURce]:RADio:DECT:PPart:SLOT0 [1] 2 3 4 5 6 7 8 9 10 11:POWer MAIN DELTA [:SOURce]:RADio:DECT:PPart:SLOT0 [1] 2 3 4 5 6 7 8 9 10 11:POWer?</pre> <pre>[:SOURce]:RADio:DECT:RFPart:SLOT0 [1] 2 3 4 5 6 7 8 9 10 11:POWer MAIN DELTA [:SOURce]:RADio:DECT:RFPart:SLOT0 [1] 2 3 4 5 6 7 8 9 10 11:POWer?</pre>
	<pre>[:SOURce]:RADio:EDGE:SLOT0 [1] 2 3 4 5 6 7:POWer MAIN DELTA [:SOURce]:RADio:EDGE:SLOT0 [1] 2 3 4 5 6 7:POWer?</pre>
	<pre>[:SOURce]:RADio[:NADC]:SLOT[1] 2 3 4 5 6:POWer MAIN DELTA [:SOURce]:RADio[:NADC]:SLOT[1] 2 3 4 5 6:POWer?</pre>
	<pre>[:SOURce]:RADio:PHS:DLINK:SLOT[1] 2 3 4:POWer MAIN DELTA [:SOURce]:RADio:PHS:DLINK:SLOT[1] 2 3 4:POWer?</pre>
	<pre>[:SOURce]:RADio:PHS:ULINK:SLOT[1] 2 3 4:POWer MAIN DELTA [:SOURce]:RADio:PHS:ULINK:SLOT[1] 2 3 4:POWer?</pre>
	<pre>[:SOURce]:RADio:TETra:SLOT[1] 2 3 4:POWer MAIN DELTA [:SOURce]:RADio:TETra:SLOT[1] 2 3 4:POWer?</pre>

Key	SCPI Command
Timeslot Off On	[:SOURCE]:RADIO:DECT:PPart:SLOT0 [1] 2 3 4 5 6 7 8 9 10 11:STATE ON OFF 1 0 [:SOURCE]:RADIO:DECT:PPart:SLOT0 [1] 2 3 4 5 6 7 8 9 10 11:STATE?
	[:SOURCE]:RADIO:DECT:RFPart:SLOT0 [1] 2 3 4 5 6 7 8 9 10 11:STATE ON OFF 1 0 [:SOURCE]:RADIO:DECT:RFPart:SLOT0 [1] 2 3 4 5 6 7 8 9 10 11:STATE?
	[:SOURCE]:RADIO:EDGE GSM:SLOT0 [1] 2 3 4 5 6 7:STATE ON OFF 1 0 [:SOURCE]:RADIO:EDGE GSM:SLOT0 [1] 2 3 4 5 6 7:STATE?
	[:SOURCE]:RADIO:NADC:SLOT[1] 2 3 4 5 6:STATE ON OFF 1 0 [:SOURCE]:RADIO:NADC:SLOT[1] 2 3 4 5 6:STATE?
	[:SOURCE]:RADIO:PDC:SLOT0 [1] 2 3 4 5:STATE ON OFF 1 0 [:SOURCE]:RADIO:PDC:SLOT0 [1] 2 3 4 5:STATE?
	[:SOURCE]:RADIO:PHS:DLINK:SLOT[1] 2 3 4:STATE ON OFF 1 0 [:SOURCE]:RADIO:PHS:DLINK:SLOT[1] 2 3 4:STATE?
	[:SOURCE]:RADIO:PHS:ULINK:SLOT[1] 2 3 4:STATE ON OFF 1 0 [:SOURCE]:RADIO:PHS:ULINK:SLOT[1] 2 3 4:STATE?
Timeslot Power Main Delta	[:SOURCE]:RADIO:GSM:SLOT0 [1] 2 3 4 5 6 7:POWER MAIN DELTA [:SOURCE]:RADIO:GSM:SLOT0 [1] 2 3 4 5 6 7:POWER?
	[:SOURCE]:RADIO:PDC:SLOT0 [1] 2 3 4 5:POWER MAIN DELTA [:SOURCE]:RADIO:PDC:SLOT0 [1] 2 3 4 5:POWER?

Key	SCPI Command
Timeslot Type	[:SOURCE]:RADio:DECT:PPart:SLOT0 [1] 2 3 4 5 6 7 8 9 10 11[:TYPE] CUSTom TRAFFic LCAPacity ZTRAFFic ZLCapacity [:SOURCE]:RADio:DECT:PPart:SLOT0 [1] 2 3 4 5 6 7 8 9 10 11[:TYPE]?
	[:SOURCE]:RADio:DECT:RFPart:SLOT0 [1] 2 3 4 5 6 7 8 9 10 11[:TYPE] CUSTom DUMM[1] DUMM2 TRAFFic LCAPacity ZTRAFFic ZLCapacity [:SOURCE]:RADio:DECT:RFPart:SLOT0 [1] 2 3 4 5 6 7 8 9 10 11[:TYPE]?
	[:SOURCE]:RADio:EDGE:SLOT0 [1] 2 3 4 5 6 7[:TYPE] CUSTom NORMAl NORMAl_ALL [:SOURCE]:RADio:EDGE:SLOT0 [1] 2 3 4 5 6 7[:TYPE]?
	[:SOURCE]:RADio:GSM:SLOT0 [1] 2 3 4 5 6 7[:TYPE] CUSTom NORMAl FCORrection SYNC DUMMy ACCEss NORMAl_ALL [:SOURCE]:RADio:GSM:SLOT0 [1] 2 3 4 5 6 7[:TYPE]?
	[:SOURCE]:RADio[:NADC]:SLOT[1] 2 3 4 5 6[:TYPE] UCUSTom DCUSTom UTCH UTCH_ALL DTCH DTCH_ALL [:SOURCE]:RADio[:NADC]:SLOT[1] 2 3 4 5 6[:TYPE]?
	[:SOURCE]:RADio:PDC:SLOT0 [1] 2 3 4 5[:TYPE] UCUSTom DCUSTom UTCH UTCH_ALL UVOX DTCH DTCH_ALL [:SOURCE]:RADio:PDC:SLOT0 [1] 2 3 4 5[:TYPE]?
	[:SOURCE]:RADio:PHS:DLINK:SLOT[1] 2 3 4[:TYPE] CUSTom TCH TCH_ALL SYNC [:SOURCE]:RADio:PHS:DLINK:SLOT[1] 2 3 4[:TYPE]?
	[:SOURCE]:RADio:PHS:ULINK:SLOT[1] 2 3 4[:TYPE] CUSTom TCH TCH_ALL SYNC [:SOURCE]:RADio:PHS:ULINK:SLOT[1] 2 3 4[:TYPE]?
Traffic Bearer	[:SOURCE]:RADio:DECT:PPart:SLOT0 [1] 2 3 4 5 6 7 8 9 10 11 [:TYPE] TRAFFic [:SOURCE]:RADio:DECT:PPart:SLOT0 [1] 2 3 4 5 6 7 8 9 10 11[:TYPE]?
	[:SOURCE]:RADio:DECT:RFPart:SLOT0 [1] 2 3 4 5 6 7 8 9 10 11 [:TYPE] TRAFFic [:SOURCE]:RADio:DECT:RFPart:SLOT0 [1] 2 3 4 5 6 7 8 9 10 11[:TYPE]?
Traffic Bearer with Z field	[:SOURCE]:RADio:DECT:PPart:SLOT0 [1] 2 3 4 5 6 7 8 9 10 11 [:TYPE] ZTRAFFic [:SOURCE]:RADio:DECT:PPart:SLOT0 [1] 2 3 4 5 6 7 8 9 10 11[:TYPE]?
Trigger In Polarity Neg Pos	:TRIGger[:SEQuence]:SLOPe POSitive NEGative
	:TRIGger[:SEQuence]:SLOPe?

Key	SCPI Command
Trigger Key	[:SOURCE]:RADio:CUSTom:TRIGger[:SOURCE] KEY [:SOURCE]:RADio:CUSTom:TRIGger[:SOURCE]?
	[:SOURCE]:RADio:<desired format>:TRIGger[:SOURCE] KEY [:SOURCE]:RADio:<desired format>:TRIGger[:SOURCE]?
TS	[:SOURCE]:RADio:EDGE:SLOT0 1 2 3 4 5 6 7:NORMal:TSEquence TSC0 TSC1 TSC2 TSC3 TSC4 TSC5 TSC6 TSC7 <78bit_pattern> [:SOURCE]:RADio:EDGE:SLOT0 1 2 3 4 5 6 7:NORMal:TSEquence?
	[:SOURCE]:RADio:GSM:SLOT0 1 2 3 4 5 6 7:DUMMy:TSEquence <bit-pattern> [:SOURCE]:RADio:GSM:SLOT0 1 2 3 4 5 6 7:DUMMy:TSEquence?
TSC0 - TSC7	[:SOURCE]:RADio:GSM:SLOT0 1 2 3 4 5 6 7:NORMal:TSEquence <bit-pattern> [:SOURCE]:RADio:GSM:SLOT0 1 2 3 4 5 6 7:NORMal:TSEquence?
	[:SOURCE]:RADio:GSM:SLOT0 1 2 3 4 5 6 7:SYNc:TSEquence <bit-pattern> [:SOURCE]:RADio:GSM:SLOT0 1 2 3 4 5 6 7:SYNc:TSEquence?
	[:SOURCE]:RADio:TETRA:SLOT[1] 2 3 4:DCNormal:TSEquence <30-bit value> [:SOURCE]:RADio:TETRA:SLOT[1] 2 3 4:DCNormal:TSEquence?
	[:SOURCE]:RADio:TETRA:SLOT[1] 2 3 4:DDNormal:TSEquence <30-bit value> [:SOURCE]:RADio:TETRA:SLOT[1] 2 3 4:DDNormal:TSEquence?
	[:SOURCE]:RADio:TETRA:SLOT[1] 2 3 4:UC1:TSEquence <30-bit value> [:SOURCE]:RADio:TETRA:SLOT[1] 2 3 4:UC1:TSEquence?
	[:SOURCE]:RADio:TETRA:SLOT[1] 2 3 4:UC2:TSEquence <30-bit value> [:SOURCE]:RADio:TETRA:SLOT[1] 2 3 4:UC2:TSEquence?
UN3/4 GSM Gaussian	[:SOURCE]:RADio:TETRA:SLOT[1] 2 3 4:UNORMal:TSEquence <22-bit value> [:SOURCE]:RADio:TETRA:SLOT[1] 2 3 4:UNORMal:TSEquence?
	[:SOURCE]:RADio:EDGE GSM:SLOT0 [1] 2 3 4 5 6 7:NORMal:TSEquence TSC0 TSC1 TSC2 TSC3 TSC4 TSC5 TSC6 TSC7 [:SOURCE]:RADio:EDGE GSM:SLOT0 [1] 2 3 4 5 6 7:NORMal:TSEquence?
Uncoded	[:SOURCE]:RADio:CUSTom:FILTer UGGaussian [:SOURCE]:RADio:CUSTom:FILTer?
	[:SOURCE]:RADio:<desired format>:FILTer UGGaussian [:SOURCE]:RADio:<desired format>:FILTer?
Up Control 1	[:SOURCE]:RADio:EDGE:SLOT0 [1] 2 3 4 5 6 7:NORMal:ENCRyption:UNCoded PN9 PN15 [:SOURCE]:RADio:EDGE:SLOT0 [1] 2 3 4 5 6 7:NORMal:ENCRyption:UNCoded?
Up Control 2	[:SOURCE]:RADio:TETRA:SLOT[1] 2 3 4[:TYPE] UC1 [:SOURCE]:RADio:TETRA:SLOT[1] 2 3 4[:TYPE]?
Up Control 2	[:SOURCE]:RADio:TETRA:SLOT[1] 2 3 4[:TYPE] UC2 [:SOURCE]:RADio:TETRA:SLOT[1] 2 3 4[:TYPE]?

Key	SCPI Command
Up Custom	[:SOURce]:RADio[:NADC]:SLOT[1] 2 3 4 5 6[:TYPE] UCUSom [:SOURce]:RADio[:NADC]:SLOT[1] 2 3 4 5 6[:TYPE]?
	[:SOURce]:RADio:PDC:SLOT0 [1] 2 3 4 5[:TYPE] UCUSom [:SOURce]:RADio:PDC:SLOT0 [1] 2 3 4 5[:TYPE]?
	[:SOURce]:RADio:TETRa:SLOT[1] 2 3 4[:TYPE] UCUSom [:SOURce]:RADio:TETRa:SLOT[1] 2 3 4[:TYPE]?
Uplink MCS-1	[:SOURce]:RADio:GSM:SLOT0 [1] 2 3 4 5 6 7:NORMal:ENCRyption:ULINk:MCS1:DATA {PN9} PN15 [:SOURce]:RADio:GSM:SLOT0 [1] 2 3 4 5 6 7:NORMal:ENCRyption:ULINk:MCS1:DATA?
Uplink MCS-5	[:SOURce]:RADio:EDGE:SLOT0 [1] 2 3 4 5 6 7:NORMal:ENCRyption:ULINk:MCS5:DATA {PN9} PN15 [:SOURce]:RADio:EDGE:SLOT0 [1] 2 3 4 5 6 7:NORMal:ENCRyption:ULINk:MCS5:DATA?
Uplink MCS-9	[:SOURce]:RADio:EDGE:SLOT0 [1] 2 3 4 5 6 7:NORMal:ENCRyption:ULINk:MCS9:DATA {PN9} PN15 [:SOURce]:RADio:EDGE:SLOT0 [1] 2 3 4 5 6 7:NORMal:ENCRyption:ULINk:MCS9:DATA?
Up Normal	[:SOURce]:RADio:TETRa:SLOT[1] 2 3 4[:TYPE] UNORMal [:SOURce]:RADio:TETRa:SLOT[1] 2 3 4[:TYPE]?
Up TCH	[:SOURce]:RADio[:NADC]:SLOT[1] 2 3 4 5 6[:TYPE] UTCH [:SOURce]:RADio[:NADC]:SLOT[1] 2 3 4 5 6[:TYPE]?
	[:SOURce]:RADio:PDC:SLOT0 [1] 2 3 4 5[:TYPE] UTCH [:SOURce]:RADio:PDC:SLOT0 [1] 2 3 4 5[:TYPE]?
Up TCH All	[:SOURce]:RADio[:NADC]:SLOT[1] 2 3 4 5 6[:TYPE] UTCH_ALL [:SOURce]:RADio[:NADC]:SLOT[1] 2 3 4 5 6[:TYPE]?
	[:SOURce]:RADio:PDC:SLOT0 [1] 2 3 4 5[:TYPE] UTCH_ALL [:SOURce]:RADio:PDC:SLOT0 [1] 2 3 4 5[:TYPE]?
Up VOX	[:SOURce]:RADio:PDC:SLOT0 [1] 2 3 4 5[:TYPE] UVOX [:SOURce]:RADio:PDC:SLOT0 [1] 2 3 4 5[:TYPE]?

Key	SCPI Command
User File	<pre>[:SOURce]:RADio:<desired format>:BURSt:SHApe[:TYPE] "<file name>" [:SOURce]:RADio:<desired format>:BURSt:SHApe[:TYPE]?</pre>
	<pre>[:SOURce]:RADio:CUSTom:DATA "<file name>" [:SOURce]:RADio:CUSTom:DATA?</pre>
	<pre>[:SOURce]:RADio:DECT:DATA "<file name>" [:SOURce]:RADio:DECT:DATA?</pre>
	<pre>[:SOURce]:RADio:DECT:PPart:SLOT0 [1] 2 3 4 5 6 7 8 9 10 11:LCAPacity[B:] "<file name>" [:SOURce]:RADio:DECT:PPart:SLOT0 [1] 2 3 4 5 6 7 8 9 10 11:LCAPacity[B:]?</pre>
	<pre>[:SOURce]:RADio:DECT:PPart:SLOT0 [1] 2 3 4 5 6 7 8 9 10 11:TRAFfic[B:] "<file name>" [:SOURce]:RADio:DECT:PPart:SLOT0 [1] 2 3 4 5 6 7 8 9 10 11:TRAFfic[B:]?</pre>
	<pre>[:SOURce]:RADio:DECT:PPart:SLOT0 [1] 2 3 4 5 6 7 8 9 10 11:ZLCapacity[B:] "<file name>" [:SOURce]:RADio:DECT:PPart:SLOT0 [1] 2 3 4 5 6 7 8 9 10 11:ZLCapacity[B:]?</pre>
	<pre>[:SOURce]:RADio:DECT:PPart:SLOT0 [1] 2 3 4 5 6 7 8 9 10 11:ZTRAffic[B:] "<file name>" [:SOURce]:RADio:DECT:PPart:SLOT0 [1] 2 3 4 5 6 7 8 9 10 11:ZTRAffic[B:]?</pre>
	<pre>[:SOURce]:RADio:DECT:RFPart:SLOT0 [1] 2 3 4 5 6 7 8 9 10 11:LCAPacity[B:] "<file name>" [:SOURce]:RADio:DECT:RFPart:SLOT0 [1] 2 3 4 5 6 7 8 9 10 11:LCAPacity[B:]?</pre>
	<pre>[:SOURce]:RADio:DECT:RFPart:SLOT0 [1] 2 3 4 5 6 7 8 9 10 11:TRAFfic[B:] "<file name>" [:SOURce]:RADio:DECT:RFPart:SLOT0 [1] 2 3 4 5 6 7 8 9 10 11:TRAFfic[B:]?</pre>
	<pre>[:SOURce]:RADio:DECT:RFPart:SLOT0 [1] 2 3 4 5 6 7 8 9 10 11:ZLCapacity[B:] "<file name>" [:SOURce]:RADio:DECT:RFPart:SLOT0 [1] 2 3 4 5 6 7 8 9 10 11:ZLCapacity[B:]?</pre>
	<pre>[:SOURce]:RADio:DECT:RFPart:SLOT0 [1] 2 3 4 5 6 7 8 9 10 11:ZTRAffic[B:] "<file name>" [:SOURce]:RADio:DECT:RFPart:SLOT0 [1] 2 3 4 5 6 7 8 9 10 11:ZTRAffic[B:]?</pre>

Key	SCPI Command
User File continued	<pre>[:SOURce]:RADio:EDGE:DATA "<file name>" [:SOURce]:RADio:EDGE:DATA? [:SOURce]:RADio:EDGE:SLOT0 [1] 2 3 4 5 6 7:CUSTom:ENCRyption "<file name>" [:SOURce]:RADio:EDGE:SLOT0 [1] 2 3 4 5 6 7:CUSTom:ENCRyption? [:SOURce]:RADio:EDGE:SLOT0 [1] 2 3 4 5 6 7:NORMal:ENCRyption "<file name>" [:SOURce]:RADio:EDGE:SLOT0 [1] 2 3 4 5 6 7:NORMal:ENCRyption?</pre>
	<pre>[:SOURce]:RADio:GSM:DATA "<file name>" [:SOURce]:RADio:GSM:DATA? [:SOURce]:RADio:GSM:SLOT0 [1] 2 3 4 5 6 7:ACCess:ENCRyption "<file name>" [:SOURce]:RADio:GSM:SLOT0 [1] 2 3 4 5 6 7:ACCess:ENCRyption? [:SOURce]:RADio:GSM:SLOT0 [1] 2 3 4 5 6 7:NORMal:ENCRyption "<file name>" [:SOURce]:RADio:GSM:SLOT0 [1] 2 3 4 5 6 7:NORMal:ENCRyption? [:SOURce]:RADio:GSM:SLOT0 [1] 2 3 4 5 6 7:SYNC:ENCRyption "<file name>" [:SOURce]:RADio:GSM:SLOT0 [1] 2 3 4 5 6 7:SYNC:ENCRyption?</pre>
	<pre>[:SOURce]:RADio[:NADC]:DATA "<file name>" [:SOURce]:RADio[:NADC]:DATA? [:SOURce]:RADio[:NADC]:SLOT0 [1] 2 3 4 5 6:DCustom "<file name>" [:SOURce]:RADio[:NADC]:SLOT0 [1] 2 3 4 5 6:DCustom? [:SOURce]:RADio[:NADC]:SLOT0 [1] 2 3 4 5 6:DTCHannel[:DATA] "<file name>" [:SOURce]:RADio[:NADC]:SLOT0 [1] 2 3 4 5 6:DTCHanne[:DATA]? [:SOURce]:RADio[:NADC]:SLOT0 [1] 2 3 4 5 6:UCustom "<file name>" [:SOURce]:RADio[:NADC]:SLOT0 [1] 2 3 4 5 6:UCustom? [:SOURce]:RADio[:NADC]:SLOT0 [1] 2 3 4 5 6:UTCHannel[:DATA] "<file name>" [:SOURce]:RADio[:NADC]:SLOT0 [1] 2 3 4 5 6:UTCHanne[:DATA]?</pre>
	<pre>[:SOURce]:RADio:PDC:DATA "<file name>" [:SOURce]:RADio:PDC:DATA? [:SOURce]:RADio:PDC:SLOT0 [1] 2 3 4 5:DCUStom "<file name>" [:SOURce]:RADio:PDC:SLOT0 [1] 2 3 4 5:DCUStom? [:SOURce]:RADio:PDC:SLOT0 [1] 2 3 4 5:DTCHannel[:TCHannel] "<file name>" [:SOURce]:RADio:PDC:SLOT0 [1] 2 3 4 5:DTCHannel[:TCHannel]? [:SOURce]:RADio:PDC:SLOT0 [1] 2 3 4 5:UCUStom "<file name>" [:SOURce]:RADio:PDC:SLOT0 [1] 2 3 4 5:UCUStom? [:SOURce]:RADio:PDC:SLOT0 [1] 2 3 4 5:UTCHannel[:TCHannel] "<file name>" [:SOURce]:RADio:PDC:SLOT0 [1] 2 3 4 5:UTCHannel[:TCHannel]?</pre>

Key	SCPI Command
User File continued	<pre>[:SOURce]:RADio:PHS:DATA "<file name>" [:SOURce]:RADio:PHS:DATA? [:SOURce]:RADio:PHS:DLINK:SLOT[1] 2 3 4:CUSTom "<file name>" [:SOURce]:RADio:PHS:DLINK:SLOT[1] 2 3 4:CUSTom? [:SOURce]:RADio:PHS:DLINK:SLOT[1] 2 3 4:TCHannel[:TCHannel] "<file name>" [:SOURce]:RADio:PHS:DLINK:SLOT[1] 2 3 4:TCHannel[:TCHannel]? [:SOURce]:RADio:PHS:ULINK:SLOT[1] 2 3 4:CUSTom "<file name>" [:SOURce]:RADio:PHS:ULINK:SLOT[1] 2 3 4:CUSTom? [:SOURce]:RADio:PHS:ULINK:SLOT[1] 2 3 4:TCHannel[:TCHannel] "<file name>" [:SOURce]:RADio:PHS:ULINK:SLOT[1] 2 3 4:TCHannel[:TCHannel]?</pre>
	<pre>[:SOURce]:RADio:TETRa:DATA "<file name>" [:SOURce]:RADio:TETRa:DATA? [:SOURce]:RADio:TETRa:SLOT[1]2 3 4 :DCCustom "<file name>" [:SOURce]:RADio:TETRa:SLOT[1]2 3 4 :DCCustom? [:SOURce]:RADio:TETRa:SLOT[1]2 3 4 :DCNormal[:DATA] "<file name>" [:SOURce]:RADio:TETRa:SLOT[1]2 3 4 :DCNormal[:DATA]? [:SOURce]:RADio:TETRa:SLOT[1]2 3 4 :DCSync[:DATA] "<file name>" [:SOURce]:RADio:TETRa:SLOT[1]2 3 4 :DCSync[:DATA]? [:SOURce]:RADio:TETRa:SLOT[1]2 3 4 :DDCustom "<file name>" [:SOURce]:RADio:TETRa:SLOT[1]2 3 4 :DDCustom? [:SOURce]:RADio:TETRa:SLOT[1]2 3 4 :DDNormal[:DATA] "<file name>" [:SOURce]:RADio:TETRa:SLOT[1]2 3 4 :DDNormal[:DATA]? [:SOURce]:RADio:TETRa:SLOT[1]2 3 4 :DDSync[:DATA] "<file name>" [:SOURce]:RADio:TETRa:SLOT[1]2 3 4 :DDSync[:DATA]? [:SOURce]:RADio:TETRa:UC1 "<file name>" [:SOURce]:RADio:TETRa:UC1? [:SOURce]:RADio:TETRa:UC2 "<file name>" [:SOURce]:RADio:TETRa:UC2? [:SOURce]:RADio:TETRa:SLOT[1]2 3 4 :UCUStom "<file name>" [:SOURce]:RADio:TETRa:SLOT[1]2 3 4 :UCUStom? [:SOURce]:RADio:TETRa:SLOT[1]2 3 4 :UNORmal "<file name>" [:SOURce]:RADio:TETRa:SLOT[1]2 3 4 :UNORmal?</pre>
User FIR	<pre>[:SOURce]:RADio:CUSTom:FILTer "<file name>" [:SOURce]:RADio:CUSTom:FILTer?</pre>
	<pre>[:SOURce]:RADio:<desired format>:FILTer "<file name>" [:SOURce]:RADio:<desired format>:FILTer?</pre>

Key	SCPI Command
User FSK	<pre>[:SOURce]:RADio:CUSTom:MODulation:UFSK "<file name>" [:SOURce]:RADio:CUSTom:MODulation:UFSK? [:SOURce]:RADio:CUSTom:MODulation[:TYPE] UFSK [:SOURce]:RADio:CUSTom:MODulation[:TYPE]?</pre>
	<pre>[:SOURce]:RADio:<desired format>:MODulation:UFSK "<file name>" [:SOURce]:RADio:<desired format>:MODulation:UFSK? [:SOURce]:RADio:<desired format>:MODulation[:TYPE] UFSK [:SOURce]:RADio:<desired format>:MODulation[:TYPE]?</pre>
User I/Q	<pre>[:SOURce]:RADio:CUSTom:MODulation:UIQ "<file name>" [:SOURce]:RADio:CUSTom:MODulation:UIQ? [:SOURce]:RADio:CUSTom:MODulation[:TYPE] UIQ [:SOURce]:RADio:CUSTom:MODulation[:TYPE]?</pre>
	<pre>[:SOURce]:RADio:<desired format>:MODulation:UIQ "<file name>" [:SOURce]:RADio:<desired format>:MODulation:UIQ? [:SOURce]:RADio:<desired format>:MODulation[:TYPE] UIQ [:SOURce]:RADio:<desired format>:MODulation[:TYPE]?</pre>
UW	<pre>[:SOURce]:RADio:PHS:DLINK:SLOT[1] 2 3 4:SCHannel:UWORD <bit_pattern> [:SOURce]:RADio:PHS:DLINK:SLOT[1] 2 3 4:SCHannel:UWORD? [:SOURce]:RADio:PHS:DLINK:SLOT[1] 2 3 4:TCHannel:UWORD <bit_pattern> [:SOURce]:RADio:PHS:DLINK:SLOT[1] 2 3 4:TCHannel:UWORD? [:SOURce]:RADio:PHS:ULINK:SLOT[1] 2 3 4:SCHannel:UWORD <bit_pattern> [:SOURce]:RADio:PHS:ULINK:SLOT[1] 2 3 4:SCHannel:UWORD? [:SOURce]:RADio:PHS:ULINK:SLOT[1] 2 3 4:TCHannel:UWORD <bit_pattern> [:SOURce]:RADio:PHS:ULINK:SLOT[1] 2 3 4:TCHannel:UWORD?</pre>

6 Theory of Operation

This section contains theory of operation that will help you learn how to use the custom modulation functionality:

- [“RF Modulation with Option UN8/9”](#) on page 6-2
- [“Alternate Amplitude and Alternate Timeslot Amplitude Control \(Option UNA only\)”](#) on page 6-4
- [“Burst Shape: The Effects of Symbol Rate & Modulation Type”](#) on page 6-6
- [“Data Clock Timing Patterns”](#) on page 6-8
- [“Digital Modulation Input/Output Relationships”](#) on page 6-9
- [“Understanding Differential Data Encoding”](#) on page 6-10
- [“Understanding Differential Encoding”](#) on page 6-11

RF Modulation with Option UN8/9

The basic modulation of digital data in signal generators with Option UN8/9, from memory to RF output, occurs through the following path, as shown in the next figure. The process order is described following Figure 6-1.

Figure 6-1 ESG-D and ESG-DP Series Signal Generator Option UN8/9 Modulation Block Diagram

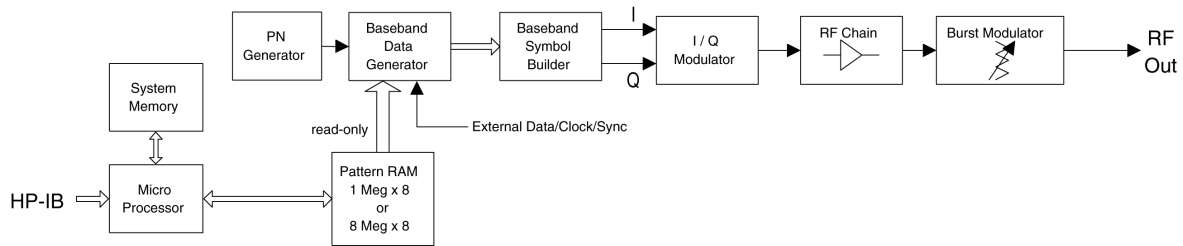

Pattern RAM

Internally generated or downloaded external data is loaded into pattern RAM (PRAM) memory by the signal generator's firmware.

Pattern RAM not only contains the data bits to be modulated, but also contains the control bits for digitally modulating the carrier with burst. For detailed information, see [“Data and Control Bits in Pattern RAM”](#) on page 6-3.

Baseband Data Generator

On each data clock, the baseband generator reads data and framing information from PRAM (pattern RAM), the PN (ITU pseudorandom data) generator, or external real-time DATA connectors (depending on instrument settings) and supplies formatted symbols to the baseband symbol builder.

For 1-bit-per-symbol modulation formats such as GMSK, one data value is read for each symbol clock period. For 2-bit-per-symbol modulation formats such as p/4DQPSK, two data values are read for each symbol clock period.

The PRAM address counter is incremented with every data clock. Therefore, each data clock cycles the PRAM address to the next byte (1 PRAM address = 1 byte). Since PRAM data is clocked into the baseband generator by the data clock and the PRAM address counter increments with the data clock, each address in PRAM can be described as an increment in time.

For continuous PN data with no framing, a dedicated hardware PN generator supplies data to the baseband generator, bypassing PRAM altogether.

Baseband Symbol Builder/Filtering Hardware

The symbol builder/filtering hardware generates the I/Q analog voltages corresponding to the selected modulation type and the selected filter type.

I/Q Modulator

The I/Q modulator supplies the modulating signal to the RF hardware.

RF Hardware

The RF hardware produces the carrier signal and modulates it with the I/Q modulator.

Burst Modulator

The burst modulator controls the amplitude of the RF signal.

Data and Control Bits in Pattern RAM

Pattern RAM not only contains the data bits to be modulated, but also contains the control bits for digitally modulating the carrier with burst.

The signal generator’s firmware adds seven control bits to each bit of data to be modulated. Therefore, each bit of user-defined data is contained within an 8-bit byte, or “address” in pattern RAM. Each byte in PRAM is organized as shown in the following table.

Table 6-1 Control Bit Definitions for a Pattern RAM Address

Bit	Function	Value	Description
0	Data	0/1	This bit is the data to be modulated. This bit is a “don’t care” when burst (bit 2) is set to 0.
1	Reserved	0	Always 0.
2	Burst	0/1	1 = RF on 0 = RF off For non-bursted, non-TDMA systems, this bit is set to 1 for all memory locations, leaving the RF output on continuously. For framed data, this bit = 1 for <i>on</i> timeslots and 0 for <i>off</i> timeslots.
3	Reserved	0	Always 0
4	Reserved	1	Always 1

When designing waveform data for subsequent direct download into pattern RAM, every bit of “modulation data” *must* be accompanied by these other seven control bits, forming an 8-bit byte that will occupy a specific address in PRAM. For further information, refer to the programming guide.

Alternate Amplitude and Alternate Timeslot Amplitude Control (Option UNA only)

The Alternate Amplitude Control feature comprises two separate subsystems, Alternate Amplitude and Alternate Timeslot Amplitude. The Alternate Amplitude Control subsystem provides the user with the capability of toggling the RF output power between a main amplitude and a definable alternate amplitude. The Alternate Timeslot Amplitude subsystem provides the capability of having different power levels on the transmitting digital data stream during framed data or non-framed external data.

Analog instruments with the Alternate Amplitude Control Option UNA are equipped with only the Alternate Amplitude subsystem. Digital instruments with baseband generators (Option UN8) have both Alternate Amplitude and Alternate Timeslot Amplitude subsystems.

NOTE The two subsystems can operate independently or coupled depended on the configuration. Similar to data generation and I/Q Burst control, the firmware provides the most intuitive approach to signal coupling, but when necessary, the user can override all firmware couplings.

Table 6-2. Summary of Firmware Couplings

Mode State	Pattern/Framed Data	Alt State	Alt Trigger	RF Output	General Comments
OFF	N/A	ON	EXT	Main and Delta Toggling	Must supply trigger input to TRIGGER IN rear panel BNC
OFF	N/A	ON	MAN	Main and Delta Toggling	Use softkey or remote command to toggle the RF
OFF	N/A	ON	INT	Main Only	INT trigger source has no effect when MODE off
ON	Int Pattern	OFF	N/A	Main or Delta (Manual Control)	Can manually turn on ALT and manually toggle RF
ON	Ext Pattern	ON	INT	Main and Delta toggling	Must supply trigger input to ALT PWR IN rear panel BNC
ON	Frame (all timeslots OFF)	OFF	N/A	No RF	Alternate amplitude has no meaning when all timeslots are off
ON	Frame (at least one timeslot on with no delta selection)	OFF	N/A	Main power during on timeslot	Alternate amplitude is off to avoid power drift when none of the timeslots are using Delta Amplitude.

Table 6-2. Summary of Firmware Couplings

Mode State	Pattern/Framed Data	Alt State	Alt Trigger	RF Output	General Comments
ON	Frame (at least one timeslot ON with delta selection)	ON	INT	Assigned MAIN or DELTA power as selected	

For instruments with Option UN8, the alternate amplitude state is turned off to stabilize the circuitry and avoid subtle power drifting if a TDMA format is on and either all timeslots are off, or none of the timeslots turned on use alternate amplitude.

During non-framed/continuous EXT data transmission, alternate state is turned on (a signal must be provided at the ALT PWR IN rear panel BNC trigger input) to allow the capability of alternating the RF output power to the transmitting pattern. During these transmissions, the trigger rate determines the duration of the toggling amplitude. This can be useful in applications where external data, clock and symbol signals are provided for external framing. By providing a ALT PWR IN trigger in signal, different amplitudes can be positioned on the transmitting pattern, similar to the alternate timeslot amplitude effect with internal framing.

For analog instruments, the INT trigger source selection has no effect and this softkey is grayed out.

For instruments with Option UN8, unless a TDMA format or a custom pattern modulation is turned on, the baseband generator does not function and the INT trigger source selection for alternate amplitude trigger has no effect.

Burst Shape: The Effects of Symbol Rate & Modulation Type

Burst shape maximum rise and fall time values are affected by the following factors:

- the symbol rate
- the modulation type

When the rise and fall delays equal 0, the burst shape is attempting to synchronize the maximum burst shape power to the beginning of the first valid symbol and the ending of the last valid symbol of the timeslot. The following figure illustrates a bursted signal in an EDGE frame with a rise delay of 0 and a fall delay of +1 bit.

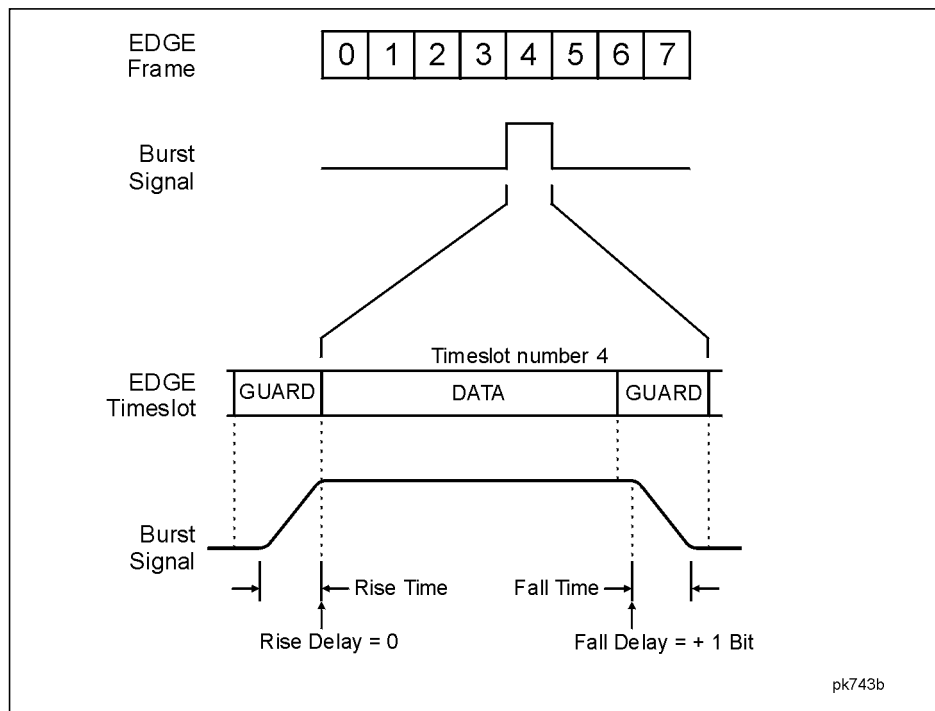

The signal generator firmware computes optimum burst shape based on the settings you've chosen for modulation. You can further optimize burst shape by lining up the data portion with the modulation. For example, if you're designing a new modulation scheme, do the following:

- Adjust the modulation and filtering to set the spectrum you want.
- Turn on framing.
- Adjust the burst rise and fall delay and rise and fall time for the timeslots.

If you find that the error vector magnitude (EVM) or adjacent channel power (ACP)

increases when you turn bursting on, you can adjust the burst shape to assist with troubleshooting.

Data Clock Timing Patterns

The following timing diagram shows the following information:

- external DATA CLOCK INPUT signal in normal and symbol modes
- SYMBOL SYNC INPUT signal in continuous and single modes
- symbol bits (2 bits per symbol)
- DATA INPUT pattern

Notice that the data should change (zero to one or one to zero) on the rising edge of the data clock and the data must be stable on the falling edge of the data clock.

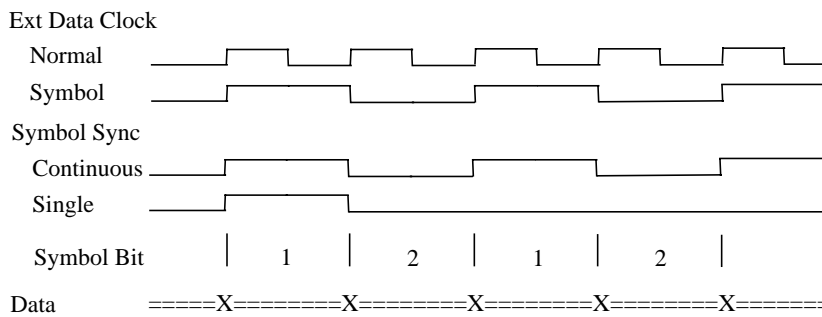

where X is data transition; = is data valid 0 or 1

Digital Modulation Input/Output Relationships

NOTE With Option 1EM, all connectors are located on the rear panel.

The baseband generator's clock can be internally or externally supplied, and the external data clock can be set to a normal bit clock or a symbol clock. Combinations of these selections will affect the inputs required and the outputs available as shown in the following table.

Table 6-3. Data Pattern Mode

Front Panel Settings			Front Panel Inputs			Rear Panel Outputs		
Data	BBG Data CLK	Ext Data Clock	DATA CLK	SYMB SYNC	DATA	DATA CLK OUT	SYMB SYNC OUT	DATA OUT
Int	Int	NA	NA	NA	NA	Internal Bit Clock	Internal Symbol Clock	Internally Generated Data
Int	Ext	Normal	User's Bit Clock	NA	NA	Internal Bit Clock	Internal Symbol Clock	Internally Generated Data
Int	Ext	Symbol	User's Symbol Clock	NA	NA	Internal Bit Clock	Internal Symbol Clock	Internally Generated Data
Ext	Int	NA	NA	User's Symbol Clock ^a	User's Ext Data ^a	Internal Bit Clock	User's Symbol Clock	User's External Data
Ext	Ext	Normal	User's Bit Clock	User's Symbol Clock	User's Ext Data	Internal Bit Clock	User's Symbol Clock	User's External Data
Ext	Ext	Symbol	User's Symbol Clock ^b	User's Symbol Clock ^b	User's Ext Data	Internal Bit Clock	User's Symbol Clock	User's External Data

- a. The front panel SYMBOL SYNC and DATA inputs must be clocked by the internal bit clock output from the rear panel DATA CLK OUT.
- b. When the user's symbol clock is supplied to the DATA CLOCK input, it must also be supplied to the SYMBOL SYNC input by means of a tee.

Understanding Differential Data Encoding

In digital modulation formats such as GSM, digital data (1's and 0's) are encoded, modulated onto a carrier frequency and subsequently transmitted to a receiver. In contrast to differential encoding (described on page 2-30), differential *data* encoding modifies the data stream *prior* to I/Q mapping. Where differential encoding encodes the raw data by using symbol table offset values to manipulate I/Q mapping at the point of modulation, differential data encoding uses *the transition from one bit value to another* to encode the raw data.

How Differential Data Encoding Works

Differential data encoding modifies the raw digitized data by creating a secondary, encoded data stream that is defined by *changes* in the digital state, from 1 to 0 or from 0 to 1, of the raw data stream. This differentially encoded data stream is then modulated and transmitted.

In differential data encoding, a *change* in a raw data bit's digital state, from 1 to 0 or from 0 to 1, produces a 1 in the encoded data stream. *No change* in digital state from one bit to the next, in other words a bit with a value of 1 followed by another bit with a value of 1 or a bit with a value of 0 followed by the same, produces a 0 in the encoded data. For instance, differentially encoding the data stream containing 01010011001010 renders 1111010101111.

Differential data encoding can be described by the following equation:

$$transmittedbit(i) = databit(i - 1) \oplus databit(i)$$

For a bit-by-bit illustration of the encoding process, see the following illustration.

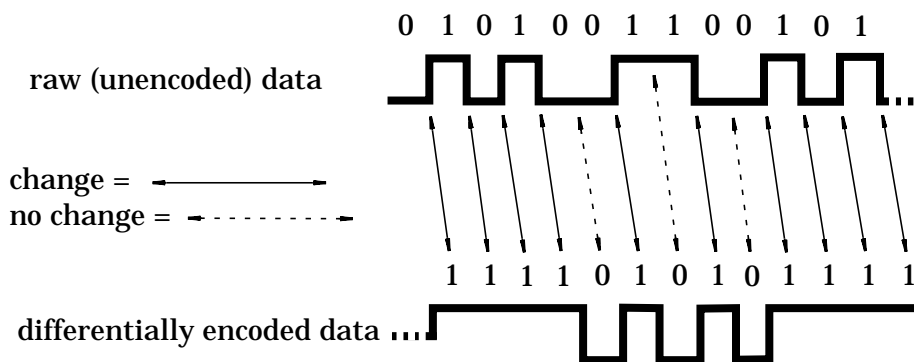

How to Access and Apply Differential Data Encoding

You can apply differential data encoding to a custom modulation by pressing **Mode** > **Real Time I/Q BaseBand** (if this key is present) > **Custom** > **Diff Data Encode Off On** until **On** is highlighted.

You can apply differential data encoding to a GSM modulation by pressing **Mode** > **Real Time I/Q BaseBand** (if this key is present) > **TDMA, GSM** > **Modify Standard** > **Diff Data Encode Off On** until **On** is highlighted.

Understanding Differential Encoding

Differential encoding is a digital-encoding technique whereby a binary value is denoted by a signal change rather than a particular signal state. Using differential encoding, binary data in any user-defined I/Q or FSK modulation can be encoded during the modulation process via symbol table offsets defined in the Differential State Map.

For example, consider the signal generator's default 4QAM I/Q modulation. (To see an I/Q State Map of this modulation, press **Mode** > **Real Time BaseBand** (if this key appears) > **Custom** > **Modulation Type** > **Define User I/Q** > **Load Default I/Q Map** > **QAM** > **4QAM**.) With a user-defined modulation based on the default 4QAM template, the I/Q State Map contains data that represent 4 symbols (00, 01, 10, and 11) mapped into the I/Q plane using 2 distinct values, 1.000000 and -1.000000. These 4 symbols can be differentially encoded during the modulation process by assigning symbol table offset values associated with each data value. The following illustration shows the 4QAM modulation in the I/Q State Map table editor.

I/Q Values Data	I Value	Q Value	Distinct Values
00000000	1.000000	1.000000	1 1.000000
00000001	-1.000000	1.000000	2 -1.000000
00000010	-1.000000	-1.000000	
00000011	1.000000	-1.000000	
00000100	-----	-----	

NOTE The number of bits per symbol can be expressed using the following formula. Because the equation is a ceiling function, if the value of x contains a fraction, x is rounded up to the next whole number.

$$x = \lceil \log_2(y) \rceil$$

Where x = bits per symbol, and y = the number of differential states.

The following illustration shows a 4QAM modulation I/Q State Map. (To see the map on the signal generator, press **Mode** > **Real Time BaseBand** (if this key appears) > **Custom** > **Modulation Type** > **Define User I/Q** > **Load Default I/Q Map** > **QAM** > **4QAM** > **Display I/Q Map**.)

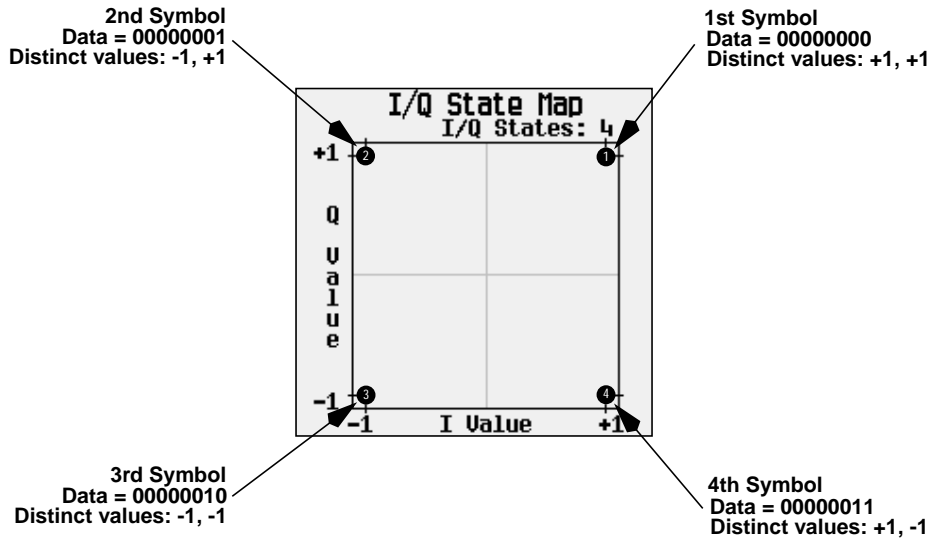

How Differential Encoding Works

Differential encoding employs offsets in the symbol table to encode user-defined modulation schemes. The Differential State Map editor is used to introduce symbol table offset values which in turn cause transitions through the I/Q State Map based on their associated data value. Whenever a data value is modulated, the offset value stored in the Differential State Map is used to encode the data by transitioning through the I/Q State Map in a direction and distance defined by the symbol table offset value.

Understanding The Differential State Map Editor

Pressing **Configure Differential Encoding** opens the Differential State Map editor. At this point, you see the data for the 1st symbol (00000000) and the cursor prepared to accept an offset value.

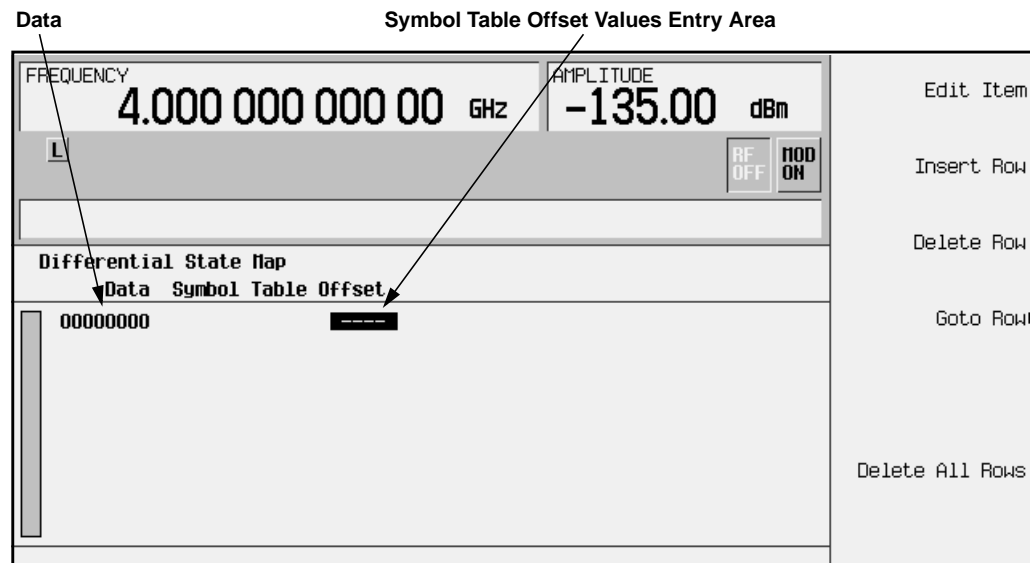

Entering a value of +1 will cause a 1-state forward transition through the I/Q State Map, as shown in the following illustration.

NOTE The following I/Q State Map illustrations show all of the possible state transitions using a particular symbol table offset value. The actual state-to-state transition would depend upon which state the modulation had started in.

Entering the following values in the Differential State Map, and pressing Return > **Differential Encoding Off On** until **On** is highlighted, differentially encodes the user-defined I/Q or FSK modulation that is present in the I/Q State Map.

- For data 00000001, enter -1.
- For data 00000010, enter 2.
- For data 00000011, enter 0.

These symbol table offsets will result in one of the transitions shown in the following illustrations.

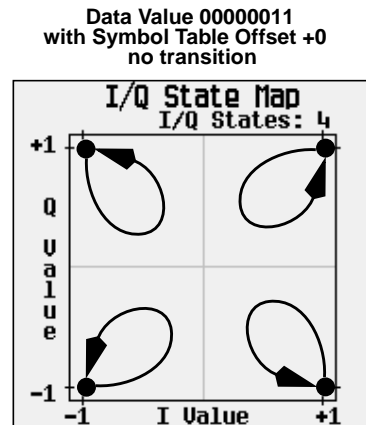
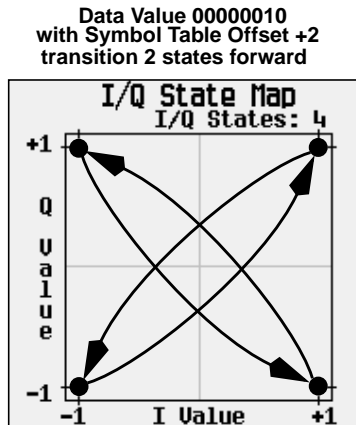
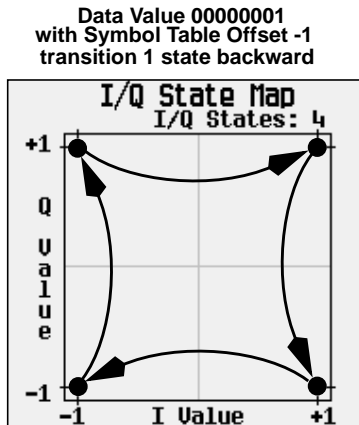
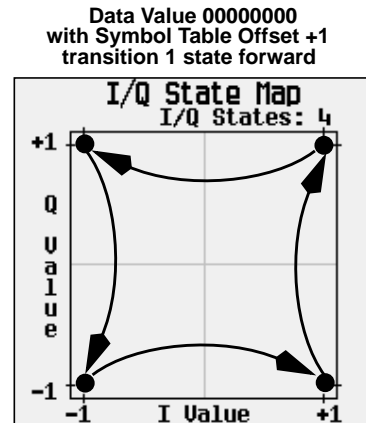

When applied to the user-defined default 4QAM I/Q map, starting from the 1st symbol (data 00), the differential encoding transitions for the data stream (in 2-bit symbols)

0011100001 appear in the following illustration.

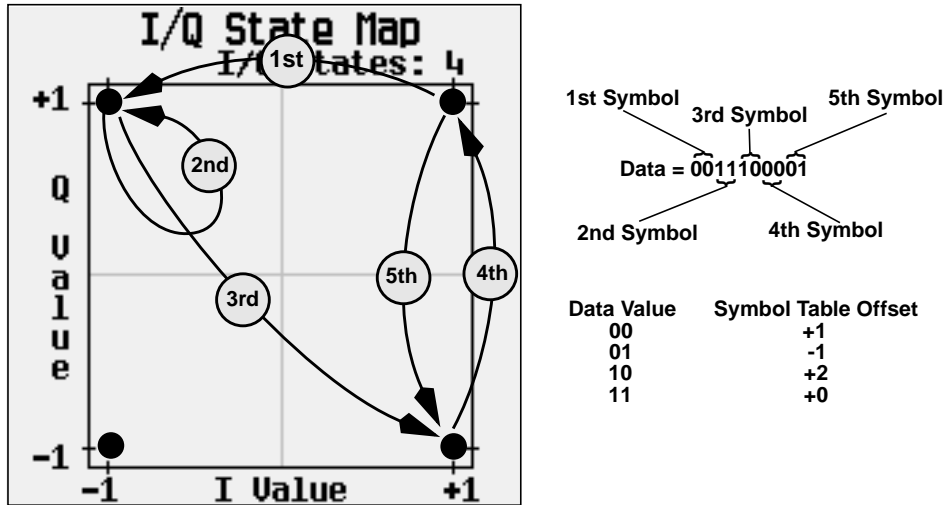

As you can see from the previous illustration, the 1st and 4th symbols, having the same data value (00), produce the same state transition (forward 1 state). In differential encoding, symbol values do not define location; they define the direction and distance of a *transition* through the I/Q State Map.

Symbols

- % softkey, [3-2](#)
- $\pi/4$ DQPSK softkey, [3-2](#)

Numerics

- 13 MHz reference, [3-89](#)
- 1500 MHz Base softkey, [3-18](#)
- 1500 MHz Mobile softkey, [3-18](#)
- 16 1's & 16 0's softkey, [3-9](#)
- 16-Lvl FSK softkey, [3-11](#)
- 16PSK softkey, [3-11](#)
- 16QAM softkey, [3-12](#)
- 256QAM softkey, [3-17](#)
- 2-Lvl FSK softkey, [3-3](#)
- 32 1's & 32 0's softkey, [3-13](#)
- 32QAM softkey, [3-14](#)
- 3-Bit softkey, [3-3](#)
- 4 1's & 4 0's softkey, [3-4](#)
- 4-bit repeating sequence, [3-96](#)
- 4-Lvl FSK softkey, [3-5](#)
- 4QAM softkey, [3-6](#)
- 64 1's & 64 0's softkey, [3-15](#)
- 64QAM softkey, [3-16](#)
- 8 1's & 8 0's softkey, [3-6](#)
- 800 MHz Base softkey, [3-17](#)
- 800 MHz Mobile softkey, [3-18](#)
- 8-Lvl FSK softkey, [3-8](#)
- 8PSK softkey, [3-9](#)

A

- A field
 - DECT, [3-42](#), [3-43](#), [3-46](#), [3-47](#), [3-54](#), [3-55](#)
- A field softkey, [3-19](#)
- Access softkey, [3-19](#)
- All Timeslots softkey, [3-19](#)
- APCO 25, [1-2](#)
- APCO 25 C4FM softkey, [3-20](#)
- APCO 25 w/C4FM softkeys, [3-20](#)
- APCO 25 w/CQPSK softkeys, [3-20](#)

B

- B field
 - DECT, [3-46](#), [3-47](#), [3-54](#), [3-55](#)
- B field softkey, [3-21](#)
- B softkey, [3-21](#)
- B1 softkey, [3-21](#)

- B2 softkey, [3-22](#)
- Base softkey, [3-22](#)
- BBG Data Clock Ext Int softkey, [3-22](#)
- Begin Frame softkey, [3-22](#)
- Begin Pattern softkey, [3-23](#)
- Begin Timeslot softkey, [3-23](#)
- Beta softkey, [3-24](#)
- Bit Clock softkey, [3-24](#)
- bits per symbol, [3-69](#)
 - differential encoding, [6-11](#)
 - FSK, [2-23](#)
 - I/Q map, [2-17](#)
- Bluetooth softkey, [3-24](#)
- Bluetooth softkeys, [1-3](#)
- BNC MUX Settings softkey, [3-24](#)
- BPSK softkey, [3-24](#)
- broadcast bits
 - TETRA, [3-21](#), [3-22](#), [3-34](#), [3-35](#)
- burst control bit, [6-3](#)
- burst shape
 - adding delay, [2-8](#)
 - changing rise and fall times, [2-8](#)
 - customizing, [2-7](#)
 - defining the curve, [2-9](#)
 - display shape, [2-10](#)
 - rise and fall editor, [2-9](#)
 - sine, [3-152](#)
- burst shape file creation SCPI command, [4-10](#)
- Burst Shape softkey, [3-25](#)
- Burst Shape Type softkey, [3-25](#)
- Bus softkey, [3-26](#)

C

- C4FM FSK softkey, [3-27](#)
- carrier, [4-101](#)
- catalogs
 - FIR files, [2-36](#)
 - FSK files, [2-37](#)
 - I/Q files, [2-35](#)
- CC softkey, [3-28](#)
- CDPD softkeys, [1-4](#), [3-28](#)
- CDVCC softkey, [3-28](#)
- cell station identification code, [3-63](#)
 - PHS, [3-51](#)
- Channel Band softkey, [3-28](#)
- channel identifier
 - PHS, [3-51](#), [3-53](#)
- Channel Number softkey, [3-29](#)

- coded digital verification color code, [3-28](#)
 - NADC, [3-39](#), [3-60](#)
 - coefficient values (FIR), entering, [2-26](#)
 - color code
 - PDC, [3-28](#), [3-40](#), [3-61](#), [3-62](#)
 - Configure Access softkey, [3-29](#)
 - Configure Differential Encoding softkey, [3-31](#)
 - Configure Dn Custom Cont softkey, [3-32](#)
 - Configure Dn Custom Disc softkey, [3-33](#)
 - Configure Dn Normal Cont softkey, [3-34](#)
 - Configure Dn Normal Disc softkey, [3-35](#)
 - Configure Dn Sync Cont softkey, [3-36](#)
 - Configure Dn Sync Disc softkey, [3-37](#)
 - Configure Dummy softkey, [3-41](#)
 - Configure FCorr softkey, [3-44](#)
 - Configure Hardware softkey, [3-45](#)
 - Configure Normal softkey, [3-47](#)
 - Configure softkeys
 - Configure Custom, [3-30](#)
 - Configure Down Custom, [3-38](#)
 - Configure Down TCH, [3-39](#)
 - Configure Dummy Bearer 1, [3-42](#)
 - Configure Dummy Bearer 2, [3-43](#)
 - Configure Frame, [3-45](#)
 - Configure Low Capacity, [3-45](#)
 - Configure Low Capacity with Z Field, [3-46](#)
 - Configure SYNC, [3-51](#)
 - Configure TCH, [3-52](#)
 - Configure Timeslots, [3-53](#)
 - Configure Traffic Bearer, [3-54](#)
 - Configure Traffic Bearer with Z Field, [3-55](#)
 - Configure Up Custom, [3-58](#)
 - Configure Sync softkey, [3-50](#)
 - Configure Up Control 1 softkey, [3-56](#)
 - Configure Up Control 2 softkey, [3-57](#)
 - Configure Up Normal softkey, [3-59](#)
 - Configure Up TCH softkey, [3-60](#), [3-61](#)
 - Configure Up VOX softkey, [3-62](#)
 - constellation diagrams
 - creating, [2-16](#)
 - editing, [2-19](#)
 - editing globally, [2-21](#)
 - storing, [2-33](#)
 - using custom, [2-35](#)
 - viewing, [2-16](#)
 - control bits for PRAM, [6-3](#)
 - Control Channel Dnlink Uplink softkey, [3-63](#)
 - Copy File softkeys, [3-63](#)
 - Create a File softkeys, [3-63](#)
 - CS-1 softkey, [3-28](#)
 - CSID softkey, [3-63](#)
 - custom modulation format overview, [1-5](#)
 - Custom Off On softkey, [3-64](#)
 - Custom softkey, [3-64](#)
 - custom timeslot
 - GSM, [3-41](#), [3-44](#)
 - Custom TS softkey, [3-65](#)
 - cyclic redundancy check display field, [3-52](#), [3-53](#)
- ## D
- D8PSK softkey, [3-66](#)
 - Data Clk Out softkey, [3-69](#)
 - data clock timing patterns, [6-8](#)
 - Data Format Pattern Framed softkey, [3-68](#)
 - Data Out softkey, [3-70](#)
 - Data softkey, [3-66](#)
 - DCS Base softkey, [3-70](#)
 - DCS Mobile softkey, [3-70](#)
 - DECT format overview, [1-6](#)
 - DECT Off On softkey, [3-70](#)
 - Dect Patterns softkey, [3-70](#)
 - DECT softkey, [3-70](#)
 - Define User Burst Shape softkey, [3-71](#)
 - Define User FIR softkey, [3-71](#)
 - Define User FSK softkey, [3-72](#)
 - Define User I/Q softkey, [3-72](#)
 - Delete All Rows softkey, [3-72](#)
 - Delete Bits softkeys, [3-73](#)
 - Delete Row softkey, [3-73](#)
 - Delete softkeys, [3-72](#)
 - Delete All Rows, [3-72](#)
 - Delete Row, [3-73](#)
 - Delete to Beginning softkeys, [3-73](#)
 - Delete to End softkeys, [3-73](#)
 - Diff Data Encode Off On softkey, [3-73](#)
 - differential data encoding
 - accessing, [6-10](#)
 - applying, [6-10](#)
 - softkey, [3-73](#)
 - theory, [6-10](#)
 - differential encoding
 - applying, [2-14](#)
 - bits per symbol, [6-11](#)
 - editing the differential state map, [2-12](#)
 - mapping custom, [2-11](#)
 - softkey, [3-73](#)
 - theory, [6-11](#)
 - Differential Encoding Off On softkey, [3-73](#)

- differential state map
 - bits per symbol, [6-11](#)
 - editing, [2-12](#)
 - table editor, [2-12](#)
 - understanding the editor, [6-12](#)
 - digital modulation
 - custom FSK, [2-22](#)
 - inputs/outputs, [6-9](#)
 - setting up custom, [2-2](#)
 - Display Burst Shape softkey, [3-74](#)
 - Display FFT softkey, [3-74](#)
 - Display I/Q Map softkey, [3-75](#)
 - Display Impulse Response softkey, [3-75](#)
 - Display softkeys
 - Display FFT, [3-74](#)
 - Display I/Q Map, [3-75](#)
 - Display Impulse Response, [3-75](#)
 - DM0 softkey, [3-76](#)
 - DM1 softkey, [3-76](#)
 - Dn Custom Cont softkey, [3-76](#)
 - Dn Custom Disc softkey, [3-77](#)
 - Dn Normal Cont softkey, [3-77](#)
 - Dn Normal Disc softkey, [3-78](#)
 - Dn Sync Cont softkey, [3-78](#)
 - Dn Sync Disc softkey, [3-79](#)
 - Down Custom softkey, [3-79](#)
 - Down TCH All softkey, [3-81](#)
 - Down TCH softkey, [3-80](#)
 - down traffic channel example, [3-39](#)
 - down traffic channel timeslot example, [3-39](#)
 - downlink custom timeslot softkey, [3-79](#)
 - Downlink MCS-1 softkey, [3-80](#)
 - Downlink MCS-5, [3-80](#)
 - Downlink MCS-5 softkey, [3-80](#)
 - Downlink MCS-9 softkey, [3-80](#)
 - downlink traffic channel softkey, [3-80](#)
 - Dummy Bearer 1 softkey, [3-81](#)
 - Dummy Bearer 2 softkey, [3-81](#)
 - Dummy softkey, [3-81](#)
- E**
- E softkey, [3-82](#)
 - EDGE (Rev 8.3.0 Release 1999) softkey, [3-83](#)
 - EDGE format overview, [1-7](#)
 - EDGE Off On softkey, [3-83](#)
 - EDGE softkey, [3-83](#)
 - Edit Fall Shape softkey, [3-84](#)
 - Edit File softkeys, [3-84](#)
 - Edit Item softkey, [3-85](#)
 - Edit Rise Shape softkey, [3-85](#)
 - Editing Keys softkeys, [3-84](#)
 - E-GSM Base softkey, [3-82](#)
 - E-GSM Mobile softkey, [3-82](#)
 - encoding, differential data, [6-10](#)
 - encryption bits, [3-48](#)
 - GSM, [3-30](#), [3-49](#), [3-50](#)
 - ET softkey, [3-85](#)
 - E-TCH/F43.2 softkey, [3-83](#)
 - EVENT 1 output, [6-3](#)
 - Event 1 softkey, [3-85](#)
 - example program
 - generating a DECT GFSK modulation sensitivity bit error test, [4-96](#)
 - generating a GSM GMSK modulation sensitivity bit error test, [4-98](#)
 - generating a PDC sensitivity bit error test, [4-100](#)
 - generating a PHS (π)/4 DQPSK modulation sensitivity bit error test, [4-90](#)
 - generating a PHS $\pi/4$ DQPSK modulation sensitivity bit error test, [4-92](#)
 - generating a TETRA (π)/4 DQPSK modulation sensitivity bit error test, [4-94](#)
 - examples
 - burst shape, customizing, [2-7](#)
 - creating a user file, [2-38](#)
 - custom modulation, setup, [2-2](#)
 - data format, selecting, [2-3](#)
 - differential encoding, [2-11](#)
 - FIR filter
 - creating, [2-26](#)
 - modifying, [2-30](#)
 - FSK modulation, creating, [2-22](#)
 - I/Q map
 - creating, [2-16](#)
 - editing, [2-19](#)
 - editing globally, [2-21](#)
 - storing, [2-33](#)
 - using custom, [2-35](#)
 - modifying existing user files, [2-40](#)
 - timeslot 1, setting up, [2-3](#)
 - timeslot 3, setting up, [2-4](#)
 - Ext Data Clock Normal Symbol softkey, [3-87](#)
 - Ext Delay Bits softkey, [3-88](#)
 - Ext softkey, [3-86](#)
 - Ext softkeys
 - Ext, [3-86](#)
 - Ext Data Clock Normal Symbol, [3-87](#)
 - Ext Delay Bits, [3-88](#)
 - Ext Delay Off On, [3-89](#)
 - extended guard time, GSM, [3-30](#)

extended tail, GSM, [3-29](#)

External 13 MHz Off On softkey, [3-89](#)

F

FACC softkey, [3-90](#)

Fall Delay softkey, [3-90](#)

Fall Time softkey, [3-91](#)

FCOR softkey, [3-91](#)

FCorr softkey, [3-91](#)

FDEV1_FS softkey, [3-92](#)

FDEV1_HS softkey, [3-92](#)

FDEV2_FS softkey, [3-92](#)

files

 FIR files catalog, [2-36](#)

 FSK files catalog, [2-37](#)

 I/Q files catalog, [2-35](#)

filter

 default, [3-69](#)

 softkeys

 Filter, [3-93](#)

 Filter Alpha, [3-93](#)

 Filter BbT, [3-94](#)

 Filter Factor N/A, [3-95](#)

 Filter Symbols, [3-95](#)

 windowed sinc function, creating, [2-26](#)

Filter Alpha softkey, [3-93](#)

Filter BbT softkey, [3-94](#)

Filter Factor N/A softkey, [3-95](#)

Filter softkey, [3-93](#)

Filter Symbols softkey, [3-95](#)

filters

 IS-95, [3-109](#)

 IS-95 and IS-2000, [3-109](#)

 IS-95 Mod, [3-109](#)

 IS-95 Mod w/EQ, [3-110](#)

 IS-95 w/EQ, [3-110](#)

FIR filter

 modifying, [2-30](#)

 user-defined, [2-26](#)

 windowed sinc function, creating, [2-26](#)

FIR table editor

 accessing, [2-26](#)

 creating user-defined filter, [2-26](#)

 duplicating coefficients using mirror table, [2-28](#)

 entering coefficient values, [2-26](#)

 loading an existing FIR file, [2-30](#)

 modifying a FIR filter, [2-30](#)

 modifying the coefficients, [2-31](#)

 setting oversample ratio, [2-28](#)

 storing filter, [2-32](#)

FIX4 softkey, [3-96](#)

frame burst, [4-101](#)

Frame Repeat Single Cont softkey, [3-97](#)

frame trigger

 softkey, [3-98](#)

Frame Trigger softkey, [3-98](#)

Freq Channels Off On softkey, [3-99](#)

Freq Channels softkey, [3-99](#)

Freq Dev softkey, [3-99](#)

frequency channel, [3-69](#)

frequency correction bits

 TETRA, [3-36](#), [3-37](#)

frequency correction bits, TETRA, [3-91](#)

FSK

 bits per symbol, [2-23](#)

 files

 creating, [2-23](#)

 selecting, [2-37](#)

 storing, [2-24](#), [2-25](#)

 table editor, [2-22](#)

FSK softkey, [3-100](#)

FSK softkeys

 16-Lvl FSK, [3-11](#)

 2-Lvl FSK, [3-3](#)

 4-Lvl FSK, [3-5](#)

 8-Lvl FSK, [3-8](#)

 C4FM, [3-27](#)

 FSK, [3-100](#)

G

G softkey, [3-101](#)

Gated Clock softkey, [3-102](#)

Gated softkey, [3-101](#)

Gaussian filter, [3-69](#)

Gaussian softkey, [3-102](#)

Globally Replace Selected Item softkey, [3-103](#)

Goto Bottom Row softkey, [3-103](#)

Goto Middle Row softkey, [3-103](#)

Goto Row softkey, [3-103](#)

Goto softkeys

 Goto Bottom Row, [3-103](#)

 Goto Middle Row, [3-103](#)

 Goto Row, [3-103](#)

 Goto Top Row, [3-103](#)

Goto Top Row softkey, [3-103](#)

Gray Coded QPSK softkey, [3-104](#)

GSM 450 Base softkey, [3-104](#)

GSM 450 Mobile softkey, [3-105](#)

GSM 450/850 Base softkey, [3-105](#)

GSM 450/850 Mobile softkey, [3-105](#)
GSM 480 Mobile softkey, [3-105](#)
GSM 850 Base softkey, [3-105](#)
GSM 850 Mobile softkey, [3-106](#)
GSM format overview, [1-8](#)
GSM Off On softkey, [3-106](#)
GSM softkey, [3-104](#)
guard time, [3-30](#), [3-42](#), [3-43](#), [3-48](#), [3-54](#), [3-55](#), [3-101](#)
 DECT, [3-45](#), [3-46](#)
 EDGE, [1-7](#)
 GSM, [1-8](#), [3-41](#), [3-44](#), [3-49](#), [3-50](#)
 PDC, [3-61](#), [3-62](#)
 TETRA, [3-33](#), [3-36](#), [3-38](#), [3-56](#), [3-57](#), [3-59](#)
guard time display field, [3-52](#), [3-53](#), [3-58](#), [3-60](#)

H

Hamming softkey, [3-107](#)
Hann softkey, [3-107](#)

I

I/Q map
 bits per symbol, [2-17](#)
 creating, [2-16](#)
 editing, [2-19](#)
 editing globally, [2-21](#)
 storing, [2-33](#)
 using custom, [2-35](#)
 viewing, [2-16](#)
I/Q scaling, [3-69](#)
I/Q Scaling softkey, [3-109](#)
I/Q table editor
 creating values, [2-16](#)
 editing globally, [2-21](#)
 editing values, [2-19](#)
 overview, [2-15](#)
 storing a custom map, [2-33](#)
 viewing symbol positions, [2-16](#)
I/Q values
 editing, [2-19](#)
 editing globally, [2-21](#)
 entering, [2-16](#)
 storing a custom map, [2-33](#)
 using a custom map, [2-35](#)
 viewing symbol positions, [2-16](#)
idle bit display field, [3-51](#)
IDLE softkey, [3-108](#)
Insert 0's softkey, [3-108](#)
Insert 1's softkey, [3-108](#)
Insert Row softkey, [3-108](#)

Insert softkey, [3-108](#)
IS-95 and IS-2000 softkey, [3-109](#)
IS-95 Mod softkey, [3-109](#)
IS-95 Mod w/EQ softkey, [3-110](#)
IS95 OQPSK softkey, [3-110](#)
IS95 QPSK softkey, [3-111](#)
IS-95 softkey, [3-109](#)
IS-95 w/EQ softkey, [3-110](#)

K

Kaiser softkey, [3-112](#)

L

Load Default FIR softkey, [3-113](#)
Load Default FSK softkey, [3-113](#)
Load Default I/Q Map softkey, [3-113](#)
Load From Selected File softkey, [3-113](#)
Load Mirror Image of Fall Shape softkey, [3-114](#)
Load Mirror Image of Rise Shape softkey, [3-114](#)
Load softkeys
 Load Default FIR, [3-113](#)
 Load Default FSK, [3-113](#)
 Load Default I/Q Map, [3-113](#)
 Load From Selected File, [3-113](#)
 Load/Store, [3-114](#)
Load/Store softkey, [3-114](#)
Low Capacity softkey, [3-115](#)
Low Capacity with Z Field softkey, [3-115](#)

M

Manual Reset & Run softkey, [3-116](#)
Mirror Table softkey, [3-116](#)
mirror table, duplicating coefficients, [2-28](#)
mixed bit field, GSM, [3-41](#)
Mobile softkey, [3-116](#)
Modify Standard softkey, [3-116](#)
Modulation Type softkey, [3-117](#)
More softkey, [3-117](#)
MSK softkey, [3-117](#)
Multiframe Channel softkey, [3-118](#)
Multiframe Data softkey, [3-118](#)
Multiframe Trigger softkey, [3-118](#)

N

NADC format overview, [1-9](#)
NADC Off On softkey, [3-119](#)
NADC softkey, [3-119](#)

None softkey, [3-119](#)

Normal All softkey, [3-120](#)

Normal softkey, [3-120](#)

Number of Bits softkey, [3-120](#)

Nyquist softkey, [3-120](#)

O

Offset Q Off On softkey, [3-122](#)

Optimize FIR For EVM ACP softkey, [3-122](#)

OQPSK softkey, [3-123](#)

Other Patterns softkey, [3-124](#)

Oversample Ratio softkey, [3-125](#)

overview

 custom modulation, [1-5](#)

 DECT, [1-6](#)

 EDGE, [1-7](#)

 GSM, [1-8](#)

 NADC, [1-9](#)

 PDC, [1-10](#)

 PHS, [1-11](#)

 TETRA, [1-12](#)

P

Page Down softkey, [3-126](#)

Page Up softkey, [3-126](#)

pattern RAM

 data and control bits, [6-3](#)

Pattern Repeat Single Cont softkey, [3-126](#)

pattern reset, [6-3](#)

Pattern Trigger softkey, [3-126](#)

PCS Base softkey, [3-127](#)

PCS Mobile softkey, [3-127](#)

PDC format overview, [1-10](#)

PDC Off On softkey, [3-127](#)

PDC softkey, [3-127](#)

personal station ID code display field, [3-51](#)

personal station ID code softkey, [3-136](#)

P-GSM Base softkey, [3-127](#)

P-GSM Mobile softkey, [3-127](#)

phase adjustment

 TETRA, [3-34](#), [3-35](#), [3-36](#), [3-37](#)

Phase Dev softkey, [3-128](#)

Phase Polarity Normal Invert softkey, [3-128](#)

PHS format overview, [1-11](#)

PHS Off On softkey, [3-128](#)

PHS softkey, [3-128](#)

PN Sequence softkey, [3-135](#)

PN softkeys

 PN Sequence, [3-135](#)

 PN11, [3-130](#)

 PN15, [3-131](#)

 PN20, [3-133](#)

 PN23, [3-134](#)

 PN9, [3-129](#)

PN11 softkey, [3-130](#)

PN15 softkey, [3-131](#)

PN20 softkey, [3-133](#)

PN23 softkey, [3-134](#)

PN9 softkey, [3-129](#)

PRAM bit definitions, [6-3](#)

preamble, [3-42](#), [3-43](#), [3-45](#), [3-46](#), [3-54](#), [3-55](#)

 PDC, [3-40](#), [3-61](#), [3-62](#)

preamble display field, [3-51](#), [3-52](#)

Predefined Mode, [4-65](#)

Predefined Mode softkeys, [3-136](#)

PSID softkey, [3-136](#)

PSK

 viewing symbol positions, [2-16](#)

PSK softkey, [3-137](#)

PSK softkeys

 16PSK, [3-11](#)

 8PSK, [3-9](#)

 D8PSK, [3-66](#)

 Gray Coded QPSK, [3-104](#)

 IS95 OQPSK, [3-110](#)

 IS95 QPSK, [3-111](#)

 OQPSK, [3-123](#)

$\pi/4$ DQPSK, [3-2](#)

 PSK, [3-137](#)

 QPSK and OQPSK, [3-140](#)

Q

QAM

 viewing symbol positions, [2-16](#)

QAM softkey, [3-138](#)

QAM softkeys

 16QAM, [3-12](#)

 256QAM, [3-17](#)

 32QAMsoftkeys

 32QAM, [3-14](#)

 4QAM, [3-6](#)

 64QAM, [3-16](#)

 QAM, [3-138](#)

QPSK softkey, [3-139](#)

QPSK softkeys

 Gray Coded QPSK, [3-104](#)

 IS95 OQPSK, [3-110](#)

QPSK softkeys (Continued)

IS95 QPSK, 3-111

OQPSK, 3-123

$\pi/4$ DQPSK, 3-2

QPSK, 3-139

QPSK and OQPSK, 3-140

R

ramp time

PDC, 3-40, 3-62

TETRA, 3-33, 3-35, 3-56, 3-57, 3-59

ramp time display field, 3-51, 3-52, 3-58, 3-60, 3-61

Rate Full Half softkey, 3-141

Recall Secondary Frame State softkey, 3-141

Rectangle softkey, 3-141

Rename softkey, 3-142

reserved field, NADC, 3-39

Reset & Run softkey, 3-142

Restore DECT Factory Default softkey, 3-142

Restore Default Burst Shape softkey, 3-143

Restore Default Filter softkey, 3-143

Restore Default Modulation Type softkey, 3-144

Restore Default softkeys

Restore DECT Factory Default, 3-142

Restore Default Burst Shape, 3-143

Restore Default Filter, 3-143

Restore Default Modulation Type, 3-144

Restore Default Symbol Rate, 3-144

Restore EDGE Factory Default, 3-145

Restore GSM Factory Default, 3-145

Restore NADC Factory Default, 3-145

Restore PDC Factory Default, 3-145

Restore PHS Factory Default, 3-145

Restore TETRA Factory Default, 3-145

Restore Default Symbol Rate softkey, 3-144

Restore EDGE Factory Default softkey, 3-145

Restore GSM Factory Default softkey, 3-145

Restore NADC Factory Default softkey, 3-145

Restore PDC Factory Default softkey, 3-145

Restore PHS Factory Default softkey, 3-145

Restore TETRA Factory Default softkey, 3-145

RF modulation

Option UN8/9, 6-2

R-GSM Base softkey, 3-145

R-GSM Mobile softkey, 3-146

Rise Delay softkey, 3-146

Rise Time softkey, 3-146

Root Nyquist softkey, 3-147

S

S softkey, 3-148

SA softkey, 3-148

SACCH softkey, 3-149

Save Secondary Frame State softkey, 3-149

SCPI commands

A field

portable part

low capacity timeslot, 4-2

low capacity with Z field timeslot, 4-2

traffic bearer timeslot, 4-2

traffic bearer with Z field timeslot, 4-3

radio fixed part

dummy timeslot, 4-3

low capacity timeslot, 4-3

traffic bearer timeslot, 4-4

B field

portable part

low capacity timeslot, 4-4

low capacity with Z field timeslot, 4-5

traffic bearer timeslot, 4-5

traffic bearer with Z field timeslot, 4-6

radio fixed part

low capacity timeslot, 4-6

low capacity with Z field timeslot, 4-7

traffic bearer timeslot, 4-7

traffic bearer with Z field timeslot, 4-8

BNC MUX

data out, 4-30

broadcast bit field

downlink continuous synchronization timeslot,
4-8

downlink discontinuous synchronization timeslot,
4-8

burst

fall delay, 4-10

fall time, 4-11

PN9 mode, 4-12

rise delay, 4-11

rise time, 4-12

shape type, 4-9

state, 4-9

burst shape files, creating, 4-10

cell station identification code (CSID) field, 4-12

coded digital channel locator (CSID) field, 4-13

coded digital verification code (CDVCC) field, 4-13

color code field, 4-13

data

custom unframed transmission, 4-29

DECT unframed transmission, 4-29

EDGE unframed transmission, 4-29

GSM unframed transmission, 4-29

NADC unframed transmission, 4-29

- data SCPI commands (Continued)*
- PDC unframed transmission, 4-29
- PHS unframed transmission, 4-29
- TETRA unframed transmission, 4-30
- data clock input configuration, 4-14
- data field, 4-20
 - access timeslot encryption field, 4-17
 - custom timeslot (EDGE), 4-15
 - custom timeslot (GSM), 4-17
 - downlink continuous custom timeslot, 4-25
 - downlink continuous normal timeslot, 4-25
 - downlink continuous synchronization timeslot, 4-26
 - downlink custom timeslot (NADC), 4-19
 - downlink custom timeslot (PDC), 4-21
 - downlink custom timeslot (PHS), 4-23
 - downlink discontinuous custom timeslot, 4-26
 - downlink discontinuous normal timeslot, 4-26
 - downlink discontinuous synchronization timeslot, 4-27
 - downlink traffic channel timeslot (NADC), 4-20
 - downlink traffic channel timeslot (PDC), 4-22
 - downlink traffic channel timeslot (PHS), 4-24
 - for framed transmissions, 4-14
 - normal timeslot encryption data field (EDGE), 4-16
 - normal timeslot encryption data field (GSM), 4-18
 - portable part
 - custom timeslot, 4-14
 - radio fixed part
 - custom timeslot, 4-15
 - synchronization timeslot encryption data field, 4-19
 - uplink control 1 timeslot, 4-27
 - uplink control 2 timeslot, 4-27
 - uplink custom timeslot (NADC), 4-20
 - uplink custom timeslot (PDC), 4-22
 - uplink custom timeslot (PHS), 4-24
 - uplink custom timeslot (TETRA), 4-28
 - uplink normal timeslot, 4-28
 - uplink traffic channel timeslot (NADC), 4-21
 - uplink traffic channel timeslot (PDC), 4-23
 - uplink traffic channel timeslot (PHS), 4-25
- data for unframed transmission, 4-29
- default state, 4-30
- differential data encoding, 4-31
- differential encoding, 4-31
- extended tail (ET) field, 4-32
- external 13 MHz reference state, 4-33
- external data clock configuration, 4-33
- external data delay query, 4-33
- external frame trigger configuration, 4-34
- external frame trigger delay bits, 4-34
- external frame trigger delay state, 4-34
- external frame trigger type, 4-34
- SCPI commands (Continued)*
- filter
 - alpha, 4-38
 - bandwidth-multiplied-by-bit-time (BbT), 4-38
 - optimization for EVM or ACP, 4-39
 - type, 4-39
- filter configuration, 4-38
- FIX4 data, 4-40
 - access timeslot encryption field, 4-45
 - custom timeslot (EDGE), 4-44
 - custom timeslot (GSM), 4-45
 - custom unframed, 4-40
 - DECT unframed, 4-40
 - downlink continuous custom timeslot, 4-50
 - downlink continuous normal timeslot, 4-50
 - downlink continuous synchronization timeslot, 4-50
 - downlink custom timeslot (NADC), 4-46
 - downlink custom timeslot (PDC), 4-47
 - downlink custom timeslot (PHS), 4-49
 - downlink discontinuous custom timeslot, 4-51
 - downlink discontinuous normal timeslot, 4-51
 - downlink discontinuous synchronization timeslot, 4-51
 - downlink traffic channel timeslot, 4-48
 - downlink traffic channel timeslot (NADC), 4-46
 - downlink traffic channel timeslot (PHS), 4-49
 - EDGE unframed transmission, 4-44
 - GSM unframed transmission, 4-45
 - NADC unframed transmission, 4-46
 - normal timeslot encryption field, 4-45
 - normal timeslot encryption field (EDGE), 4-44
 - PDC unframed transmission, 4-47
 - PHS unframed transmission, 4-48
 - portable part
 - custom timeslot, 4-41
 - low capacity timeslot B field, 4-41
 - low capacity with Z field timeslot B field, 4-42
 - traffic bearer timeslot B field, 4-41
 - traffic bearer with Z field timeslot B field, 4-42
 - radio fixed part
 - custom timeslot, 4-42
 - low capacity timeslot B field, 4-43
 - low capacity with Z field timeslot B field, 4-43
 - traffic bearer timeslot B field, 4-43
 - traffic bearer with Z field timeslot B field, 4-44
 - synchronization timeslot encryption field, 4-46
 - TETRA unframed transmission, 4-50
 - uplink control 1 timeslot, 4-51
 - uplink control 2 timeslot, 4-51
 - uplink custom timeslot (NADC), 4-47
 - uplink custom timeslot (PDC), 4-48
 - uplink custom timeslot (PHS), 4-49
 - uplink custom timeslot (TETRA), 4-52
 - uplink normal timeslot (TETRA), 4-52

-
- FIX4 data SCPI commands (Continued)*
 - uplink traffic channel timeslot (NADC), [4-47](#)
 - uplink traffic channel timeslot (PDC), [4-48](#)
 - uplink traffic channel timeslot (PHS), [4-49](#)
 - frame repeat, [4-35](#)
 - frame transmission rate, [4-35](#)
 - frequency channel band, [4-36](#)
 - frequency channel configuration, [4-36](#)
 - frequency channel mode state, [4-37](#)
 - frequency channel number, [4-37](#)
 - frequency correction (FCOR) field
 - downlink continuous synchronization timeslot, [4-52](#)
 - downlink discontinuous synchronization timeslot, [4-52](#)
 - FSK frequency deviation, [4-59](#)
 - guard field
 - custom timeslot, [4-53](#)
 - normal timeslot, [4-53](#)
 - I/Q scaling, [4-54](#)
 - idle field
 - downlink synchronization channel timeslot, [4-53](#)
 - uplink synchronization channel timeslot, [4-54](#)
 - leading broadcast bit (B1) field
 - downlink continuous normal timeslot, [4-54](#)
 - downlink discontinuous normal timeslot, [4-54](#)
 - mode state, [4-55](#)
 - modulation configuration, [4-55](#)
 - modulation type, [4-55](#)
 - custom, [4-55](#)
 - DECT, [4-55](#)
 - EDGE, [4-55](#)
 - GSM, [4-55](#)
 - NADC, [4-56](#)
 - PDC, [4-56](#)
 - PHS, [4-56](#)
 - TETRA, [4-56](#)
 - user-defined FSK, [4-57](#)
 - user-defined FSK, creating, [4-58](#)
 - user-defined I/Q, [4-58](#)
 - user-defined I/Q, creating, [4-59](#)
 - MSK phase deviation, [4-60](#)
 - Multiframe PN Sequence, [4-62](#)
 - P field
 - portable part
 - low capacity timeslot, [4-60](#)
 - low capacity with Z field timeslot, [4-60](#)
 - traffic bearer timeslot, [4-61](#)
 - traffic bearer with Z field timeslot, [4-61](#)
 - radio fixed part
 - dummy timeslot, [4-61](#)
 - low capacity timeslot, [4-61](#)
 - low capacity with Z field timeslot, [4-62](#)
 - traffic bearer timeslot, [4-62](#)
 - traffic bearer with Z field timeslot, [4-62](#)
 - SCPI commands (Continued)*
 - personal ID code
 - downlink synchronization channel timeslot, [4-64](#)
 - uplink synchronization channel timeslot, [4-64](#)
 - phase polarity, [4-64](#)
 - portable part
 - low capacity B field, [4-5](#)
 - traffic bearer B field, [4-6](#)
 - Predefined Mode, [4-65](#)
 - S field
 - portable part
 - low capacity timeslot, [4-65](#)
 - low capacity with Z field timeslot, [4-65](#)
 - traffic bearer timeslot, [4-65](#)
 - traffic bearer with Z field timeslot, [4-66](#)
 - radio fixed part
 - dummy bearer timeslots, [4-66](#)
 - low capacity timeslot, [4-66](#)
 - low capacity with Z field timeslot, [4-66](#)
 - traffic bearer timeslot, [4-67](#)
 - traffic bearer with Z field timeslot, [4-67](#)
 - scramble configuration, [4-67](#)
 - scramble seed, [4-67](#)
 - scramble state, [4-67](#)
 - secondary frame configuration, [4-68](#)
 - recall, [4-68](#)
 - save, [4-68](#)
 - state, [4-68](#)
 - trigger source, [4-68](#)
 - slow associated control channel (SACCH) field
 - downlink traffic channel timeslot (NADC), [4-69](#)
 - downlink traffic channel timeslot (PDC), [4-69](#)
 - downlink traffic channel timeslot (PHS), [4-70](#)
 - uplink traffic channel timeslot (NADC), [4-69](#)
 - uplink traffic channel timeslot (PDC), [4-70](#)
 - uplink traffic channel timeslot (PHS), [4-70](#)
 - uplink VOX timeslot (PDC), [4-70](#)
 - steal bit, [4-71](#)
 - symbol rate, [4-71](#)
 - sync output configuration, [4-71](#)
 - output offset, [4-72](#)
 - output timeslot, [4-73](#)
 - type, [4-71](#)
 - synchronization block bits (SBB) field
 - downlink continuous synchronization timeslot, [4-73](#)
 - downlink discontinuous synchronization timeslot, [4-73](#)
 - synchronization sequence field, [4-73](#)
 - synchronization training sequence bits (STS) field
 - downlink continuous synchronization timeslot, [4-74](#)
 - downlink discontinuous synchronization timeslot, [4-74](#)

SCPI commands (Continued)

synchronization word field
 downlink traffic channel timeslot (NADC), 4-74
 downlink traffic channel timeslot (PDC), 4-74
 uplink traffic channel timeslot (NADC), 4-74
 uplink traffic channel timeslot (PDC), 4-74
 UVOX channel timeslot, 4-75

tail (T1, T2) fields, 4-75

timeslot configuration, 4-75
 amplitude, 4-75
 DECT portable part timeslots, 4-75
 DECT radio fixed part timeslots, 4-75
 EDGE, 4-76
 GSM, 4-76
 NADC, 4-76
 PDC, 4-76
 PHS downlink timeslots, 4-76
 PHS uplink timeslots, 4-76
 TETRA, 4-77

state, 4-77
 DECT portable part timeslots, 4-77
 DECT radio fixed part timeslots, 4-77
 EDGE, 4-77
 GSM, 4-77
 NADC, 4-78
 PDC, 4-78
 PHS downlink timeslots, 4-78
 PHS uplink timeslots, 4-78
 TETRA, 4-78

type, 4-79
 DECT portable part timeslots, 4-79
 DECT radio fixed part timeslots, 4-79
 downlink timeslot (PHS), 4-80
 EDGE, 4-79
 GSM, 4-79
 NADC, 4-80
 PDC, 4-80
 TETRA, 4-81
 uplink timeslot (PHS), 4-80

trailing broadcast bit (B2) field
 downlink continuous normal timeslot, 4-82
 downlink discontinuous normal timeslot, 4-82

training sequence field
 downlink continuous normal timeslot, 4-85
 downlink discontinuous normal timeslot, 4-85
 downlink synchronization channel timeslot, 4-86, 4-87
 dummy timeslot (GSM), 4-83
 normal timeslot (EDGE/GSM), 4-82
 synchronization timeslot (GSM), 4-84
 uplink control 1 timeslot, 4-85
 uplink control 2 timeslot, 4-85
 uplink normal timeslot, 4-86

training sequence field SCPI commands (Continued)

 uplink synchronization channel timeslot, 4-87
 uplink traffic channel timeslot, 4-87
 trigger source, 4-86

Scramble Off On softkey, 3-149

Scramble Seed softkey, 3-150

secondary frame, 3-69

Secondary Frame Off On softkey, 3-150

Secondary Frame Trigger softkey, 3-151

Select File softkey, 3-152

Select softkey, 3-151

set
 carrier frequency, 4-101
 carrier power level, 4-101

sinc function, windowed, creating a filter, 2-26

Sine softkey, 3-152

Single Shot softkey, 3-152

slow associated control channel
 NADC, 3-39, 3-60, 3-149
 PDC, 3-40, 3-61, 3-62

softkeys
 %, 3-2
 1500 MHz Base, 3-18
 1500 MHz Mobile, 3-18
 16 1's & 16 0's, 3-9
 16-Lvl FSK, 3-11
 16PSK, 3-11
 16QAM, 3-12
 256QAM, 3-17
 2-Lvl FSK, 3-3
 32 1's & 32 0's, 3-13
 3-Bit Sync, 3-3
 4 1's & 4 0's, 3-4
 4-Lvl FSK, 3-5
 4QAM, 3-6
 64 1's & 64 0's, 3-15
 64QAM, 3-16
 8 1's & 8 0's, 3-6
 800 MHz Base, 3-17
 800 MHz Mobile, 3-18
 8-Lvl FSK, 3-8
 8PSK, 3-9
 A field, 3-19
 Access, 3-19
 All Timeslots, 3-19
 APCO 25 C4FM, 3-20
 APCO 25 w/C4FM, 3-20
 APCO 25 w/CQPSK, 3-20
 B, 3-21

softkeys (Continued)

B field, [3-21](#)
B1, [3-21](#)
B2, [3-22](#)
Base, [3-22](#)
BBG Data Clock Ext Int, [3-22](#)
Begin Frame, [3-22](#)
Begin Pattern, [3-23](#)
Begin Timeslot, [3-23](#)
Beta, [3-24](#)
Bit Clock, [3-24](#)
Bluetooth, [1-3](#), [3-24](#)
BNC MUX Settings, [3-24](#)
BPSK, [3-24](#)
Burst Shape, [3-25](#)
Burst Shape Type, [3-25](#)
Bus, [3-26](#)
CAFM FSK, [3-27](#)
CC, [3-28](#)
CDPD, [1-4](#), [3-28](#)
CDVCC, [3-28](#)
Channel Band, [3-28](#)
Channel Number, [3-29](#)
Configure Access, [3-29](#)
Configure Custom, [3-30](#)
Configure Differential Encoding, [3-31](#)
Configure Dn Custom Cont, [3-32](#)
Configure Dn Custom Disc, [3-33](#)
Configure Dn Normal Cont, [3-34](#)
Configure Dn Normal Disc, [3-35](#)
Configure Dn Sync Cont, [3-36](#)
Configure Dn Sync Disc, [3-37](#)
Configure Down Custom, [3-38](#)
Configure Down TCH, [3-39](#)
Configure Dummy, [3-41](#)
Configure Dummy Bearer 1, [3-42](#)
Configure Dummy Bearer 2, [3-43](#)
Configure FCorr, [3-44](#)
Configure Frame, [3-45](#)
Configure Hardware, [3-45](#)
Configure Low Capacity, [3-45](#)
Configure Low Capacity with Z Field, [3-46](#)
Configure Normal, [3-47](#)
Configure SYNC, [3-51](#)
Configure Sync, [3-50](#)
Configure TCH, [3-52](#)
Configure Timeslots, [3-53](#)
Configure Traffic Bearer, [3-54](#)
Configure Traffic Bearer with Z Field, [3-55](#)
Configure Up Control 1, [3-56](#)
Configure Up Control 2, [3-57](#)
Configure Up Custom, [3-58](#)

softkeys (Continued)

Configure Up Normal, [3-59](#)
Configure Up TCH, [3-60](#), [3-61](#)
Configure Up VOX, [3-62](#)
Control Channel Dnlink Uplink, [3-63](#)
Copy File, [3-63](#)
Create a File, [3-63](#)
CS-1, [3-28](#)
CSID, [3-63](#)
Custom, [3-64](#)
Custom Off On, [3-64](#)
Custom TS, [3-65](#)
D8PSK, [3-66](#)
Data, [3-66](#)
Data Clk Out, [3-69](#)
Data Format Pattern Framed, [3-68](#)
Data Out, [3-70](#)
DCS Base, [3-70](#)
DCS Mobile, [3-70](#)
DECT, [3-70](#)
DECT Off On, [3-70](#)
Dect Patterns, [3-70](#)
Define User Burst Shape, [3-71](#)
Define User FIR, [3-71](#)
Define User FSK, [3-72](#)
Define User I/Q, [3-72](#)
Delete, [3-72](#)
Delete All Rows, [3-72](#)
Delete Bits, [3-73](#)
Delete Row, [3-73](#)
Delete to Beginning, [3-73](#)
Delete to End, [3-73](#)
Diff Data Encode Off On, [3-73](#)
Differential Encoding Off On, [3-73](#)
Display Burst Shape, [3-74](#)
Display FFT, [3-74](#)
Display I/Q Map, [3-75](#)
Display Impulse Response, [3-75](#)
DM0, [3-76](#)
DM1, [3-76](#)
Dn Custom Cont, [3-76](#)
Dn Custom Disc, [3-77](#)
Dn Normal Cont, [3-77](#)
Dn Normal Disc, [3-78](#)
Dn Sync Cont, [3-78](#)
Dn Sync Disc, [3-79](#)
Down Custom, [3-79](#)
Down TCH, [3-80](#)
Down TCH All, [3-81](#)
Downlink MCS-1, [3-80](#)
Downlink MCS-5, [3-80](#)
Downlink MCS-9, [3-80](#)

softkeys (Continued)

Dummy, 3-81
Dummy Bearer 1, 3-81
Dummy Bearer 2, 3-81
E, 3-82
EDGE, 3-83
EDGE (Rev 8.3.0 Release 1999), 3-83
EDGE Off On, 3-83
Edit Fall Shape, 3-84
Edit File, 3-84
Edit Item, 3-85
Edit Rise Shape, 3-85
Editing Keys, 3-84
E-GSM Base, 3-82
E-GSM Mobile, 3-82
ET, 3-85
E-TCH/F43.2, 3-83
Event 1, 3-85
Ext, 3-86
Ext Data Clock Normal Symbol, 3-87
Ext Delay Bits, 3-88
Ext Delay Off On, 3-89
External 13 MHz Off On, 3-89
FACC, 3-90
Fall Delay, 3-90
Fall Time, 3-91
FCOR, 3-91
FCorr, 3-91
FDEV1_FS, 3-92
FDEV1_HS, 3-92
FDEV2_FS, 3-92
Filter, 3-93
Filter Alpha, 3-93
Filter BbT, 3-94
Filter Factor N/A, 3-95
Filter Symbols, 3-95
FIX4, 3-96
Frame Repeat Single Cont, 3-97
Frame Trigger, 3-98
Freq Channels, 3-99
Freq Channels Off On, 3-99
Freq Dev, 3-99
FSK, 3-100
G, 3-101
Gated, 3-101
Gated Clock, 3-102
Gaussian, 3-102
Globally Replace Selected Item, 3-103
Goto Bottom Row, 3-103
Goto Middle Row, 3-103
Goto Row, 3-103
Goto Top Row, 3-103

softkeys (Continued)

Gray Coded QPSK, 3-104
GSM, 3-104
GSM 450 Base, 3-104
GSM 450 Mobile, 3-105
GSM 450/850 Base, 3-105
GSM 450/850 Mobile, 3-105
GSM 480 Mobile, 3-105
GSM 850 Base, 3-105
GSM 850 Mobile, 3-106
GSM Off On, 3-106
Hamming, 3-107
Hann, 3-107
I/Q Scaling, 3-109
IDLE, 3-108
Insert, 3-108
Insert 0's, 3-108
Insert 1's, 3-108
Insert Row, 3-108
IS-95, 3-109
IS-95 and IS-2000, 3-109
IS-95 Mod, 3-109
IS-95 Mod w/EQ, 3-110
IS95 OQPSK, 3-110
IS95 QPSK, 3-111
IS-95 w/EQ, 3-110
Kaiser, 3-112
Load Default FIR, 3-113
Load Default FSK, 3-113
Load Default I/Q Map, 3-113
Load From Selected File, 3-113
Load Mirror Image of Fall Shape, 3-114
Load Mirror Image of Rise Shape, 3-114
Load/Store, 3-114
Low Capacity, 3-115
Low Capacity with Z Field, 3-115
Manual Reset & Run, 3-116
Mirror Table, 3-116
Mobile, 3-116
Modify Standard, 3-116
Modulation Type, 3-117
More, 3-117
MSK, 3-117
Multiframe Channel, 3-118
Multiframe Data, 3-118
Multiframe Trigger, 3-118
NADC, 3-119
NADC Off On, 3-119
None, 3-119
Normal, 3-120
Normal All, 3-120
Number of Bits, 3-120

softkeys (Continued)

Nyquist, [3-120](#)
Offset Q Off On, [3-122](#)
Optimize FIR For EVM ACP, [3-122](#)
option UN8, [3-1](#)
OQPSK, [3-123](#)
Other Patterns, [3-124](#)
Oversample Ratio, [3-125](#)
 $\pi/4$ DQPSK, [3-2](#)
Page Down, [3-126](#)
Page Up, [3-126](#)
Pattern Repeat Single Cont, [3-126](#)
Pattern Trigger, [3-126](#)
PCS Base, [3-127](#)
PCS Mobile, [3-127](#)
PDC, [3-127](#)
PDC Off On, [3-127](#)
P-GSM Base, [3-127](#)
P-GSM Mobile, [3-127](#)
Phase Dev, [3-128](#)
Phase Polarity Normal Invert, [3-128](#)
PHS, [3-128](#)
PHS Off On, [3-128](#)
PN Sequence, [3-135](#)
PN11, [3-130](#)
PN15, [3-131](#)
PN20, [3-133](#)
PN23, [3-134](#)
PN9, [3-129](#)
Predefined Mode, [3-136](#)
PSID, [3-136](#)
PSK, [3-137](#)
QAM, [3-138](#)
QPSK, [3-139](#)
QPSK and OQPSK, [3-140](#)
Rate Full Half, [3-141](#)
Recall Secondary Frame State, [3-141](#)
Rectangle, [3-141](#)
Rename, [3-142](#)
Reset & Run, [3-142](#)
Restore DECT Factory Default, [3-142](#)
Restore Default Burst Shape, [3-143](#)
Restore Default Filter, [3-143](#)
Restore Default Modulation Type, [3-144](#)
Restore Default Symbol Rate, [3-144](#)
Restore EDGE Factory Default, [3-145](#)
Restore GSM Factory Default, [3-145](#)
Restore NADC Factory Default, [3-145](#)
Restore PDC Factory Default, [3-145](#)
Restore PHS Factory Default, [3-145](#)
Restore TETRA Factory Default, [3-145](#)
R-GSM Base, [3-145](#)

softkeys (Continued)

R-GSM Mobile, [3-146](#)
Rise Delay, [3-146](#)
Rise Time, [3-146](#)
Root Nyquist, [3-147](#)
S, [3-148](#)
SA, [3-148](#)
SACCH, [3-149](#)
Save Secondary Frame State, [3-149](#)
Scramble Off On, [3-149](#)
Scramble Seed, [3-150](#)
Secondary Frame Off On, [3-150](#)
Secondary Frame Trigger, [3-151](#)
Select, [3-151](#)
Select File, [3-152](#)
Sine, [3-152](#)
Single Shot, [3-152](#)
SS, [3-153](#)
SSB, [3-154](#)
Standard, [3-154](#)
Store To File, [3-154](#)
STS, [3-154](#)
SW, [3-155](#)
Symbol Rate, [3-155](#)
Symbol Sync Out, [3-155](#)
SYNC, [3-156](#)
Sync, [3-156](#)
Sync Out, [3-156](#)
Sync Out Offset, [3-157](#)
T1, [3-158](#)
T2, [3-158](#)
TCH, [3-158](#)
TCH All, [3-159](#)
TCH/FS, [3-159](#)
TDMA, [3-159](#)
TETRA, [3-159](#)
TETRA Off On, [3-160](#)
Timeslot #, [3-160](#)
Timeslot Ampl Main Delta, [3-160](#)
Timeslot Off On, [3-161](#)
Timeslot Type, [3-161](#)
Traffic Bearer, [3-162](#)
Traffic Bearer with Z Field, [3-162](#)
Transmit Link RFP PP, [3-162](#)
Trigger In Polarity Neg Pos, [3-163](#)
Trigger Key, [3-163](#)
TS, [3-164](#)
TSC0 - TSC7, [3-165](#)
UN3/4 GSM Gaussian, [3-166](#)
Uncoded, [3-166](#)
Up Control 1, [3-166](#)
Up Control 2, [3-167](#)

-
- softkeys (Continued)*
 - Up Custom, 3-167
 - Up Normal, 3-169
 - Up TCH, 3-169
 - Up TCH All, 3-169
 - Up VOX, 3-170
 - Uplink MCS-1, 3-168
 - Uplink MCS-5, 3-168
 - Uplink MCS-9, 3-168
 - User File, 3-170
 - User FIR, 3-172
 - User FSK, 3-172
 - User I/Q, 3-172
 - UW, 3-173
 - Window, 3-174
 - SS softkey, 3-153
 - SSB softkey, 3-154
 - Standard softkey, 3-154
 - start symbol display field, 3-51, 3-52
 - steal flag
 - PDC, 3-40, 3-61, 3-62
 - Store To File softkey, 3-154
 - STS softkey, 3-154
 - SW softkey, 3-155
 - symbol positions
 - creating custom, 2-16
 - editing, 2-19
 - editing globally, 2-21
 - storing custom, 2-33
 - viewing, 2-16
 - symbol rate, 3-69
 - Symbol Rate softkey, 3-155
 - Symbol Sync Out softkey, 3-155
 - Sync Out Offset softkey, 3-157
 - Sync Out softkey, 3-156
 - SYNC softkey, 3-156
 - Sync softkey, 3-156
 - synchronization block bits
 - TETRA, 3-36, 3-37
 - synchronization block bits (SSB), 3-154
 - synchronization block bits, TETRA, 3-154
 - synchronization output offset, 4-72
 - synchronization sequence
 - GSM, 3-29
 - synchronization training sequence
 - TETRA, 3-36, 3-38
 - synchronization training sequence bits (STS), 3-154
 - synchronization word, 3-42, 3-43, 3-46, 3-47, 3-54, 3-55
 - PDC, 3-40, 3-61, 3-62, 3-155
 - synchronization word field, 3-39, 3-60
- ## T
- T1 softkey, 3-158
 - T2 softkey, 3-158
 - table editors
 - differential state map, 2-12
 - FSK, 2-22
 - I/Q symbol map
 - creating, 2-16
 - editing, 2-19
 - editing globally, 2-21
 - overview, 2-15
 - storing custom, 2-33
 - viewing, 2-16
 - tail bits, 3-48
 - GSM, 3-30, 3-41, 3-44, 3-49, 3-50
 - TETRA, 3-56, 3-57, 3-59
 - tail field, 3-158
 - TCH All softkey, 3-159
 - TCH softkey, 3-158
 - TCH/FS softkey, 3-159
 - TDMA softkey, 3-159
 - TETRA format overview, 1-12
 - TETRA Off On softkey, 3-160
 - TETRA softkey, 3-159
 - Timeslot # softkey, 3-160
 - Timeslot Ampl Main Delta softkey, 3-160
 - Timeslot Off On softkey, 3-161
 - Timeslot Type softkey, 3-161
 - timeslot type, normal GSM, 3-120
 - timeslots, 4-101
 - timing diagrams, 6-8
 - timing patterns, data clock, 6-8
 - Traffic Bearer softkey, 3-162
 - Traffic Bearer with Z Field softkey, 3-162
 - training sequence, 3-48, 3-65
 - GSM, 3-41, 3-50, 3-164
 - TETRA, 3-34, 3-35, 3-36, 3-37, 3-56, 3-57, 3-59
 - training sequence code, 3-165
 - training sequence, GSM, 3-49
 - Transmit Link RFP PP softkey, 3-162
 - Trigger In Polarity Neg Pos softkey, 3-163
 - Trigger Key softkey, 3-163
 - TS softkey, 3-164
 - TSC0 - TSC7 softkeys, 3-165
- ## U
- UN3/4 GSM Gaussian softkey, 3-166

Uncoded softkey, [3-166](#)
unique word display field, [3-51](#), [3-52](#)
unique word softkey, [3-173](#)
Up Control 1 softkey, [3-166](#)
Up Control 2 softkey, [3-167](#)
Up Custom softkey, [3-167](#)
Up Normal softkey, [3-169](#)
Up TCH All softkey, [3-169](#)
Up TCH softkey, [3-169](#)
Up VOX softkey, [3-170](#)
Uplink MCS-1 softkey, [3-168](#)
Uplink MCS-5 softkey, [3-168](#)
Uplink MCS-9 softkey, [3-168](#)
uplink traffic channel timeslot
 PDC, [3-61](#)
User File softkey, [3-170](#)
user files
 creating, [2-38](#)
 FIR files catalog, [2-36](#)
 FSK files catalog, [2-37](#)
 I/Q files catalog, [2-35](#)
 modifying existing user files, [2-40](#)
 size in framed transmissions, [3-170](#)
 using the Bit File Editor, [2-38](#)
User FIR softkey, [3-172](#)
User FSK modulation, [2-22](#)
User FSK softkey, [3-172](#)
User I/Q softkey, [3-172](#)
User softkeys
 User File, [3-170](#)
 User FIR, [3-172](#)
 User FSK, [3-172](#)
 User I/Q, [3-172](#)
UW softkey, [3-173](#)

W

wait, [4-101](#)
Window softkey, [3-174](#)
windowed sinc function FIR filter, creating, [2-26](#)

X

X field, [3-47](#), [3-55](#)

Z

Z field, [3-46](#), [3-47](#), [3-54](#), [3-55](#)

